

Carmon

High Precision Tooling



CATALOGO | CATALOGUE

Carmon
High Precision Tooling

Carmon

Dalla tradizione creiamo innovazione Creating innovation from tradition

Carmon nasce nel 1969, specializzandosi nella produzione di utensili di precisione per la lavorazione dei metalli, forte della radicata tradizione italiana in questo particolare settore.

In pochi anni emerge per competenza ed affidabilità: espande la propria attività ai mercati internazionali, amplia la gamma dei prodotti per fornire un pacchetto completo e competitivo e rafforza il reparto utensileria speciale, attraverso una costante attività di studio su materiali e applicazioni.

L'attenzione dedicata negli anni al parco macchine ha potuto garantire la flessibilità necessaria a far crescere il brand e l'azienda in tutti i suoi settori, tanto da riuscire ad ottenere per prima tra le aziende del suo calibro, nel 1995, la certificazione ISO.

In quest'ottica Carmon si distingue per un servizio just-in-time, per cui ogni ordine viene evaso in 24 ore dal ricevimento, e un efficiente reparto post-vendita.

Nel 2018, Carmon decide di allargare ulteriormente il proprio orizzonte, grazie all'acquisizione di Ergus - storico brand nel campo della produzione di saldatrici professionali, macchine per il taglio plasma e inverters - con cui condivide non solo i mercati, ma anche i valori.

In questa amplificazione di scenari ed incontro di sinergie, i brand Carmon ed Ergus continuano ad impegnarsi per evolvere e conservare il proprio patrimonio tecnico Made in Italy.

Carmon, founded in 1969, manufactures high-precision tooling, drawing from the deeply-rooted Italian expertise in this very specialized field.

In a few years Carmon stands out for competence and reliability, beginning the expansion towards foreign markets, enlarging the range of products to provide a comprehensive and competitive offer and introducing a customized tooling department by constantly studying materials and applications.

A lot of attention, over the years, has been posed to the manufacturing equipment, to assure the flexibility required to make the brand growing. So much so that Carmon has been the first to be ISO certified in 1995.

Consequently, Carmon stands out for an efficient after-sales department and a just-in-time service, that allows any order to be processed within 24 hours.

In 2018 Carmon widens further its activities, by taking over Ergus - historical brand in the field of professional welding machines, plasma cutters and inverters - with whom shares not only the markets but also the values.

In this variety of scenarios and meeting of synergies Carmon and Ergus continue striving to evolve, being careful to preserve the technical Made in Italy heritage.

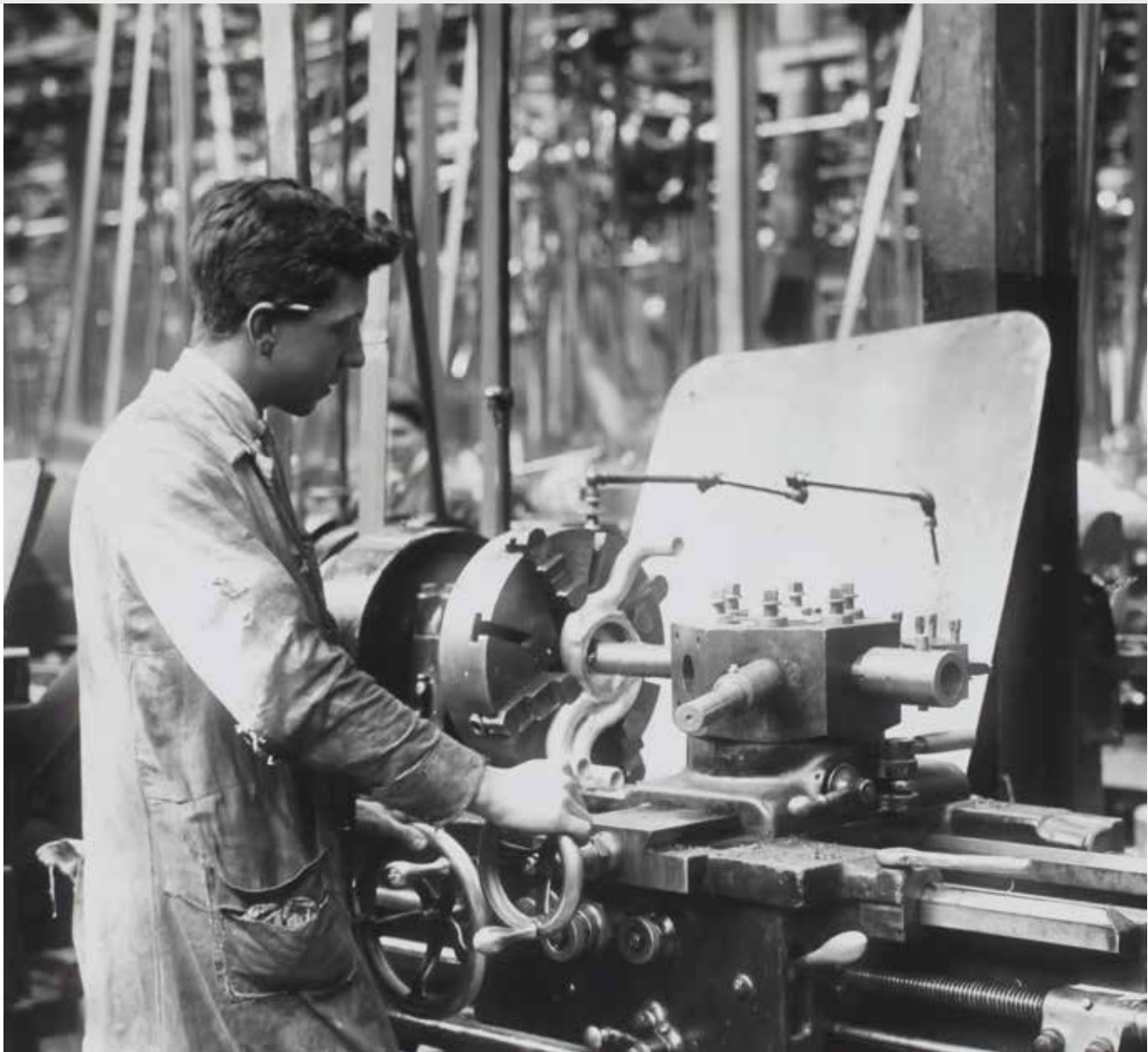

In un panorama che cambia costantemente vogliamo essere un punto fermo di affidabilità e non poniamo limiti alle possibilità.

Carmon è nata dalla visione dei due fondatori di creare un'azienda virtuosa, che continuasse nel tempo, preservando l'eredità tecnica e umana della loro storia imprenditoriale, ma attenta ad accogliere i cambiamenti come opportunità.

Attraverso la nostra esperienza forniamo ai nostri clienti un servizio che si distingue e un prodotto che rende l'industria più efficiente.

Lavoriamo ogni giorno per crescere, impegnandoci a costruire relazioni basate sulla trasparenza e la competenza.

We want to be a trustworthy staple in an ever-changing industrial panorama, keeping ourselves open to possibilities.

Carmon has taken shape from the vision of the founders, who wanted to create a virtuous company that could last and grow over time, safeguarding the human and technical legacy of their entrepreneurship, but welcoming change as an opportunity.

Through our expertise we provide our customers with a distinguished service, and a product that makes the industry more efficient.

We work hard, every day, to improve and create transparent and qualified relationships.

Carmon

**PUNTE HSS
HSS DRILLS**

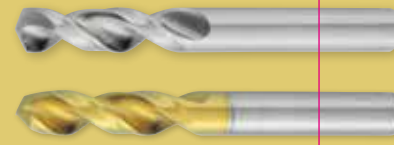

**ALESATORI - SVASATORI
REAMERS - COUNTERSINKS**

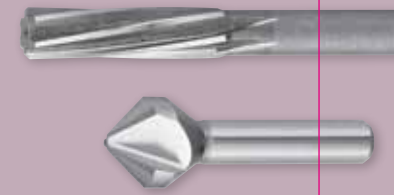

**MASCHI - FILIERE
TAPS - DIES**



**TAMPONI - ANELLI
GAUGES - RINGS**



**FRESE HSS
HSS MILLING CUTTERS**

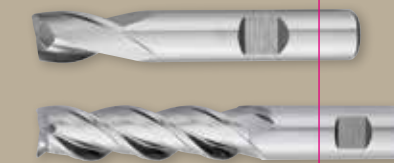

**FRESE E PUNTE HM
HM MILLING CUTTERS & DRILLS**

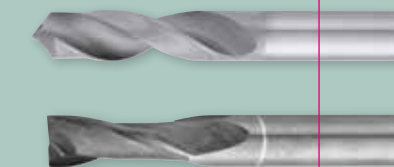

**LIME ROTATIVE HM
HM ROTARY BURRS**

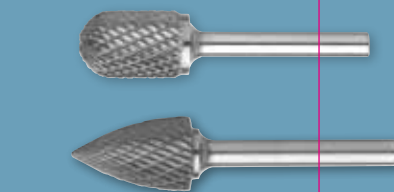

**KIT
TOOLS SET**

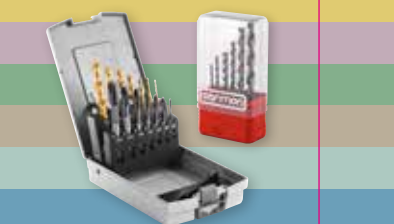

TECH INFO

Indice analitico Analytical index



PUNTE HSS HSS DRILLS

CL 100	24
CL 101	24
CL 102	55
CL 103	55
CL 104	31
CL 104R	31
CL 104CR	37
CL 105	38
CL 106	38
CL 107	31
CL 108	31
CL 109	42
CL 110/1	51
CL 110/2	52
CL 110/3	53
CL 111/1	51
CL 111/2	52
CL 111/3	53
CL 118	28
CL 119	44
CL 150	54
CL 200	47
CL 230	47
CL 270	58
CL 271	58
CL 272	59
CM 300	60
CM 301	66
CM 302	66
CM 303	60
CM 304	68
CM 305	70
CM 306	68
CM 307	70
CM 370	72
CM 371	72
CM 372	73
CL 910	56
CL 920	56
CL 930	57



ALESATORI - SVASATORI REAMERS - COUNTERSINKS

BR 51	90
BR 52	91
SV 72	87
SV 74	87
SV 75	88
SV 76	89
SV 77	89
AL 111	80
AM 112	84
AMM 113	85
MAN 114	86
AS 115	81
AFE 116	85
AM 117	82



MASCHI TAPS

CL 28M HM	184
CL 29MF HM	185
M 500	116
M 501	116
M 502	128
M 503	129
G 504	140
M 505	133
M 506	135
MF 507	138
M 508	127
M 509	130
MF 510	120
M 511	132
M 512	134
M 513	163
M 514	131
M 515	167
M 516	158
M 517	158
M 518 SX	117

M 519 SX	117
MF 520	136
M 521 S	129
MF 522 S	137
M 523	118
M 524	169
M 525 RESISTOR	170
M 526 RESISTOR	171
M 527 RESISTOR	173
M 528 RESISTOR	175
G-M 529 RESISTOR	177
MF 530	137
M 531	151
M 532	152
M 533 RESISTOR	172
M 534 RESISTOR	174
M 535	157
M 536	157
G537 RESISTOR	178
G538 RESISTOR	178
M 539 HM	183
G 540	123
M 541	165
M 542 RESISTOR	166
M 543	168
M 544	164
M 545	154
M 546	153
MF 547	159
MF 548	160
EG-M 549 RESISTOR	176
G 550	139
G 551	141
G 552	162
G 553	161
G 554 RESISTOR	124
G 555	124
UNC 556	125
UNF 558	126
UNC 559	144
UNC 560	142
UNC 561	143
UNF 562	145

Indice analitico Analytical index

UNF 563	146
UNF 564	147
UNF 565 RESISTOR	181
UNF 567 RESISTOR	182
R 570	187
R 571	187
R 572	187
R 573 RESISTOR	188
R 574 RESISTOR	189
UNC 575 RESISTOR	179
UNC 576 RESISTOR	180
W 580	148
W 581	149
NPT 590	150
PG 591	155
M 595 RESISTOR	119
MF 596 RESISTOR	122
GM 685	190
PM 700	156
P HM 701	186

FILIERE - DIES

FMF 600	192
FM 610	191
FG 620	197
FGX 622	197
FMS 630	191
FMFS 640	192
FUNC 645	195
FUNF 650	196
FW 660	198
FMX 670	191
FMFX 680	192
FNPT 690	199
FPG 691	200
PF 856	201



TAMPONI - ANELLI
GAUGES - RINGS

TL 800	204
TF M 810	205

TF MF 811	206
TF G 812	208
TF UNC 813	209
TF UNF 814	210
TF NPT 815	211
AF M 820	205
AF M 821	205
AF MF 822	206
AF MF 823	206
AF G 824	208
AF G 825	208



FRESE HSS
HSS MILLING CUTTERS

CL 11	232
CL 12	234
CL 13 F	235
CL 16	238
CL 17	240
CL 18	236
CL 19	237
CL 21 TF	241
CL 22 TF	242
CL 24 TF	243
CL 24 TF PF	244
CL 24 SL TF	245
CL 24 SL TF PF	246
CL 25 TF	247
CL 30 FE	239
CM 31	248
CM 36	249
CM 37 FE	249
CM 38	250
CL 41 TF	251
CM 41 R	252
CM 42	252
CM 42R	253
CM 43	253
CM 44 TF	254
CM 44 R	252
CM 45 TF	256

CS 47	257
CM 48	255
CM 48R	253
TCL 60 A	258
TCL 60 B	258
TCL 61	259
TCL 62	260
TCM 63	261
CR 81	263
CR 83	265
CR 85	268
FA 91	269
FP 92	270
CF 94	271
CF 95	271
CF 96	272
CF 97	272
CF 98	273
CF 99	273
SCR 121	274
SCV 131	275
SCC 132	276
RC 135	262
MOD 141	277
ALL 156	278
ALL 157	278
ALL 158	279
ALL 160 RESISTOR	280
ALL 162 RESISTOR	281
ALL 164 RESISTOR	280
ALL 166 RESISTOR	281



FRESE E PUNTE HM
HM MILLING CUTTERS & DRILLS

CL 11 HM	294
CL 11 HMB	295
CL 11 Cr HM	296
CL 11 Rs HM	297
CL 12 HM	298
CL 16 HM	301
CL 16 HMB	302

Indice analitico Analytical index

CL 16 Cr HM	303
CL16 R HM	305
CL16 Rs HM	304
CL 17 HM	306
CL 17 R HM	307
CL 18 HM	299
CL 18 SL HM	300
CL 19 HM	322
CL 19 CM HM	322
CL 21 TF HM	308
CL 21 TF HMB	309
CL 21 Cr HM	310
CL 21 R HM	312
CL 21 Rs HM	311
CL 21 ED HM	313
CL 22 R HM	316
CL 22 ED HM	314
CL 22 TF HM	315
CL 24 TF PF HM	317
CL 25 TF HM	317
CL 26 HM	323
CL 26 SL HM	323
CL 27 CR HM	324
CL 27 CRLS HM	325
CL 28 M HM	184
CL 29 MF HM	185
CS 47 HM	318
ALL 158 HM	319
ALL 161 HM	320
ALL 163 HM	321
CL 400 HM	326
CL 410 HM	328
CL 415 HM	329
CL 420 HM	332
CL 425 HM	329
CL 430 HM	332
CL 435 HM	335



LIME ROTATIVE HM HM ROTARY BURRS

A401	340
A402	340
A403	340
A404	340
A406	340
B401	340
B402	340
B403	340
B404	340
B406	340
C401	341
C402	341
C403	341
C404	341
C406	341
D401	342
D402	342
D403	342
D404	342
D406	342
E401	343
E402	343
E403	343
E404	343
E406	343
F401	343
F402	343
F403	343
F404	343
F406	343
G401	344
G402	344
G403	344
G404	344
G406	344
H401	344
H402	344
H403	344
H404	344
H406	344

J402	345
J403	345
J404	345
J406	345
K402	345
K403	345
K404	345
K406	345
L401	346
L402	346
L403	346
L404	346
L406	346
M401	346
M402	346
M403	346
M404	346
M406	346
N402	347
N403	347
N404	347
N406	347



KIT PUNTE DRILLS SET

CL 101	361
CL 104	360
CL 104 R	360
CL 105	361
CL 106	360



KIT SVASATORI COUNTERSINKS SET

SV 74 (3 - 5 - 6 PZ)	362
SV 75 (3 - 5 - 6 PZ)	363
SV 76 (3 - 5 - 6 PZ)	364



KIT MASCHI TAPS SET

AS 500 (7 PZ)	365
M 508 (6 PZ)	369
M508 + CL101 (14 PZ)	366
M508+CL104 (14 PZ)	366
M508+CL104R (14 PZ)	366
M508+CL106 (14 PZ)	366
M 509 (6 PZ)	370
M 511 (6 PZ)	372
M 512 (6 PZ)	372
M512 + CL101 (14 PZ)	368
M512 +CL104 (14 PZ)	368
M512+CL104R (14 PZ)	368
M512+CL106 (14 PZ)	368
M 513 (6 PZ)	370
M 516 (6 PZ)	370
M 516 + CL 104R (14 PZ)	366
M 516 + CL 119 (14 PZ)	366
M 517 (6 PZ)	371
M 517 + CL 104R (14 PZ)	368
M 517 + CL 106 (14 PZ)	368
M 517 + CL 119 (14 PZ)	368
M 524 (6 PZ) RESISTOR	373
M 533 + CL 106 (14 PZ)	367
M 534 + CL 106 (14 PZ)	369
M 535 (6 PZ)	371
M 535 + CL 104R (14 PZ)	365
M 535 + CL 119 (14 PZ)	365
M 536 (6 PZ)	371
M 536 + CL 104R (14 PZ)	367
M 536 + CL 119 (14 PZ)	367
R 570 (6 PZ)	372
R 571 (6 PZ)	373
R 572 (6 PZ)	373



KIT FRESE RIVESTITE COATED MILLS SET

CL 11 (6 PZ) RESISTOR	374
CL 21TF (6 PZ) RESISTOR	374
CL 24TF (6 PZ) RESISTOR	374
CL 24TFPF (6 PZ) RESISTOR	374





















KIT FRESE HM RIVESTITE COATED HM MILLS SET



















CL 11 HM (5 PZ)	375
CL 16 HM (5 PZ)	375
CL 18 HM (5 PZ)	375
CL 19 HM (5 PZ)	376
CL 21 HM ED (5 PZ)	376
CL 21TF HM (5 PZ)	376
CL 26 HM (5 PZ)	376



































KIT LIME ROTATIVE ROTARY BURRS SETS





KIT LIME 401 (8 PZ)	377
KIT LIME 406 (8 - 10 PZ)	377

Articolo Article	Tipo Type	Campo d'applicazione Application field	Angolo vertice Point angle	Materiale tipo Tool material	Superficie Surface	Standard	gamma dal (mm) diameter range (mm)	pag page
PUNTE CODOLO CILINDRICO STRAIGHT SHANK TWIST DRILLS								
PUNTE EXTRA CORTE TWIST DRILLS, STUB LENGHT								
 CL 100	N	Acciai comuni Standard steel	118°	HSS	Black	DIN 1897	1,00 - 13,00	24
 CL 101	W	Acciai tenaci Hardened steel	130°	HSS-8%Co	White	DIN 1897	1,00 - 31,00	24
 CL 101	W	Acciai tenaci Hardened steel	130°	HSS-8%Co	Quartz	DIN 1897	1,00 - 31,00	24
 CL 101	W	Acciai tenaci Hardened steel	130°	HSS-8%Co	Titanite	DIN 1897	1,00 - 31,00	24
 CL 118	S	Acciai inox Stainless steel	135°	HSS+5%CO	White	DIN 1897	2,00 - 16,00	28
 CL 118	S	Acciai inox Stainless steel	135°	HSS+5%CO	Quartz	DIN 1897	2,00 - 16,00	28
 CL 118	S	Acciai inox Stainless steel	135°	HSS+5%CO	Titanite	DIN 1897	2,00 - 16,00	28
PUNTE CORTE TWIST DRILLS JOBBER LENGHT								
 CL 104	N	Acciai comuni Standard steel	118°	HSS	Black	DIN 338	0,30 - 20,00	31
 CL 104R	N	Acciai comuni Standard steel	130°	HSS	Quartz	DIN 338	1,00 - 20,00	31
 CL 107	H	Ottone-Bronzo- Rame-Brass- Bronze-Copper	118°	HSS	White	DIN 338	1,50 - 13,00	31
 CL 108	W	Alluminio Aluminum	130°	HSS	White	DIN 338	1,50 - 13,00	31
 CL 104CR	N	Acciai comuni Standard steel	118°	HSS	Black	DIN 338	13,50 - 20,00	37
 CL 106	W	Acciai tenaci Hardened steel	130°	HSS+5%CO	White	DIN 338	0,30 - 13,00	38
 CL 106	W	Acciai tenaci Hardened steel	130°	HSS+5%CO	Quartz	DIN 338	0,30 - 13,00	38
 CL 106	W	Acciai tenaci Hardened steel	130°	HSS+5%CO	Titanite	DIN 338	0,30 - 13,00	38
 CL 105	W	Acciai tenaci Hardened steel	130°	HSS+8%CO	White	DIN 338	2,00 - 20,00	38
 CL 105	W	Acciai tenaci Hardened steel	130°	HSS+8%CO	Quartz	DIN 338	2,00 - 20,00	38
 CL 105	W	Acciai tenaci Hardened steel	130°	HSS+8%CO	Titanite	DIN 338	2,00 - 20,00	38

Articolo Article	Tipo Type	Campo d'applicazione Application field	Angolo vertice Point angle	Materiale tipo Tool material	Superficie Surface	Standard	gamma dal (mm) diameter range (mm)	pag page
PUNTE LUNGHE TWIST DRILLS, LONG SERIES								
 CL 109	S	Acciai comuni Standard steel	130°	HSS+5%CO	White	DIN 338	2,00 - 13,00	42
 CL 109	S	Acciai comuni Standard steel	130°	HSS+5%CO	Quartz	DIN 338	2,00 - 13,00	42
 CL 109	S	Acciai comuni Standard steel	130°	HSS+5%CO	Titanite	DIN 338	2,00 - 13,00	42
 CL 119	S	Acciai inox Stainless steel	135°	HSS+5%CO	White	DIN 338	2,00 - 16,00	44
 CL 119	S	Acciai inox Stainless steel	135°	HSS+5%CO	Quartz	DIN 338	2,00 - 16,00	44
 CL 119	S	Acciai inox Stainless steel	135°	HSS+5%CO	Titanite	DIN 338	2,00 - 16,00	44
 CL 200 FORI PROFONDI DEEP HOLE	N	Acciai comuni Standard steel	118°	HSS	Black	DIN 340	0,50 - 20,00	47
 CL 230 FORI PROFONDI DEEP HOLE	S	Acciai tenaci Hardened steel	135°	HSS+5%CO	White	DIN 340	2,00 - 13,00	47
 CL 230 FORI PROFONDI DEEP HOLE	S	Acciai tenaci Hardened steel	135°	HSS+5%CO	Quartz	DIN 340	2,00 - 13,00	47
 CL 230 FORI PROFONDI DEEP HOLE	S	Acciai tenaci Hardened steel	135°	HSS+5%CO	Titanite	DIN 340	2,00 - 13,00	47
PUNTE EXTRA LUNGHE TWIST DRILLS, EXTRA LONG SERIES								
 CL 111-1 FORI PROFONDI DEEP HOLE	N	Acciai comuni Standard steel	118°	HSS	Black	DIN 1869/1	2,00 - 13,00	51
 CL 110-1 FORI PROFONDI DEEP HOLE	S	Acciai tenaci Hardened steel	135°	HSS+5%CO	White	DIN 1869/1	2,00 - 13,00	51
 CL 110-1 FORI PROFONDI DEEP HOLE	S	Acciai tenaci Hardened steel	135°	HSS+5%CO	Quartz	DIN 1869/1	2,00 - 13,00	51
 CL 110-1 FORI PROFONDI DEEP HOLE	S	Acciai tenaci Hardened steel	135°	HSS+5%CO	Titanite	DIN 1869/1	2,00 - 13,00	51
 CL 111-2 FORI PROFONDI DEEP HOLE	N	Acciai comuni Standard steel	118°	HSS	Black	DIN 1869/2	3,00 - 13,00	52
 CL 110-2 FORI PROFONDI DEEP HOLE	S	Acciai tenaci Hardened steel	135°	HSS+5%CO	White	DIN 1869/2	3,00 - 13,00	52
 CL 110-2 FORI PROFONDI DEEP HOLE	S	Acciai tenaci Hardened steel	135°	HSS+5%CO	Quartz	DIN 1869/2	3,00 - 13,00	52
 CL 110-2 FORI PROFONDI DEEP HOLE	S	Acciai tenaci Hardened steel	135°	HSS+5%CO	Titanite	DIN 1869/2	3,00 - 13,00	52

Articolo Article	Tipo Type	Campo d'applicazione Application field	Angolo vertice Point angle	Materiale tipo Tool material	Superficie Surface	Standard	gamma dal (mm) diameter range (mm)	pag page
 CL 111-3 FORI PROFONDI DEEP HOLE	N	Acciai comuni Standard steel	118°	HSS	Black	DIN 1869/3	3,50 - 13,00	53
 CL 110-3 FORI PROFONDI DEEP HOLE	S	Acciai tenaci Hardened steel	135°	HSS+5%CO	White	DIN 1869/3	3,50 - 13,00	53
 CL 110-3 FORI PROFONDI DEEP HOLE	S	Acciai tenaci Hardened steel	135°	HSS+5%CO	Quartz	DIN 1869/3	3,50 - 13,00	53
 CL 110-3 FORI PROFONDI DEEP HOLE	S	Acciai tenaci Hardened steel	135°	HSS+5%CO	Titanite	DIN 1869/3	3,50 - 13,00	53
PUNTE EXTRA CORTE DOPPIE DOUBLE TWIST DRILLS STUB LENGTH								
 CL 150	N	Acciai comuni Standard steel	118°	HSS	Black	CARMON NORM	2,20 - 6,00	54
PUNTE PER CENTRI NC NC-SPOTTING DRILLS								
 CL 102	N	Acciai comuni Standard steel	120°	HSS+8%CO	White	CARMON NORM	6,00 - 20,00	55
 CL 102	N	Acciai comuni Standard steel	120°	HSS+8%CO	Quartz	CARMON NORM	6,00 - 20,00	55
 CL 102	N	Acciai comuni Standard steel	120°	HSS+8%CO	Titanite	CARMON NORM	6,00 - 20,00	55
 CL 103	N	Acciai comuni Standard steel	90°	HSS+8%CO	White	CARMON NORM	6,00 - 20,00	55
 CL 103	N	Acciai comuni Standard steel	90°	HSS+8%CO	Quartz	CARMON NORM	6,00 - 20,00	55
 CL 103	N	Acciai comuni Standard steel	90°	HSS+8%CO	Titanite	CARMON NORM	6,00 - 20,00	55
PUNTE DA CENTRO CENTER DRILLS								
 CL 910		Acciai comuni Standard steel	118°	HSS	White	DIN 333/A	1,00 - 6,3	56
 CL 910		Acciai comuni Standard steel	118°	HSS	Quartz	DIN 333/A	1,00 - 6,3	56
 CL 920		Acciai comuni Standard steel	118°	HSS	White	DIN 333/R	1,00 - 6,3	56
 CL 920		Acciai comuni Standard steel	118°	HSS	Quartz	DIN 333/R	1,00 - 6,3	56
 CL 930		Acciai comuni Standard steel	118°	HSS	White	DIN 333/B	1,00 - 6,3	57
 CL 930		Acciai comuni Standard steel	118°	HSS	Quartz	DIN 333/B	1,00 - 6,3	57

Articolo Article	Tipo Type	Campo d'applicazione Application field	Angolo vertice Point angle	Materiale tipo Tool material	Superficie Surface	Standard	gamma dal (mm) diameter range (mm)	pag page
PUNTE A GRADINO CON ELICHE INDIPENDENTI SUBLAND DRILLS WITH INDIPENDENT SPIRAL								
 CL270	N	Acciai comuni Standard steel	118°	HSS	White	DIN 8376	M3 - M10	58
 CL271	N	Acciai comuni Standard steel	118°	HSS	White	DIN 8374	M3 - M8	58
 CL272	N	Acciai comuni Standard steel	118°	HSS	White	DIN 8378	M3 - M12	59
PUNTE CODOLO CONICO TAPER SHANK TWIST DRILLS								
PUNTE STANDARD STANDARD TWIST DRILL								
 CM 300	N	Acciai comuni Standard steel	118°	HSS	Black	DIN 345	3,00 - 100,00	60
 CM 303	N	Acciai tenaci Hardened steel	118°	HSS+5%CO	White	DIN 345	5,00 - 50,00	60
 CM 303	N	Acciai tenaci Hardened steel	118°	HSS+5%CO	Quartz	DIN 345	5,00 - 24,00	60
 CM 303	N	Acciai tenaci Hardened steel	118°	HSS+5%CO	Titanite	DIN 345	5,00 - 24,00	60
PUNTE LUNGHE TWIST DRILL LONG SERIES								
 CM 301 FORI PROFONDI DEEP HOLE	N	Acciai comuni Standard steel	118°	HSS	Black	DIN 341	8,00 - 30,00	66
 CM 302 FORI PROFONDI DEEP HOLE	S	Acciai tenaci Hardened steel	135°	HSS+5%CO	White	DIN 341	8,00 - 30,00	66
 CM 302 FORI PROFONDI DEEP HOLE	S	Acciai tenaci Hardened steel	135°	HSS+5%CO	Quartz	DIN 341	8,00 - 24,00	66
 CM 302 FORI PROFONDI DEEP HOLE	S	Acciai tenaci Hardened steel	135°	HSS+5%CO	Titanite	DIN 341	8,00 - 24,00	66
PUNTE EXTRA LUNGHE TWIST DRILLS EXTRA LONG SERIES								
 CM 304 FORI PROFONDI DEEP HOLE	N	Acciai comuni Standard steel	118°	HSS	Black	DIN 1870/ 1	8,00 - 50,00	68
 CM 306 FORI PROFONDI DEEP HOLE	S	Acciai tenaci Hardened steel	135°	HSS+5%CO	White	DIN 1870/ 1	8,00 - 31,00	68
 CM 306 FORI PROFONDI DEEP HOLE	S	Acciai tenaci Hardened steel	135°	HSS+5%CO	Quartz	DIN 1870/ 1	8,00 - 17,00	68
 CM 306 FORI PROFONDI DEEP HOLE	S	Acciai tenaci Hardened steel	135°	HSS+5%CO	Titanite	DIN 1870/ 1	8,00 - 17,00	68
 CM 305 FORI PROFONDI DEEP HOLE	N	Acciai comuni Standard steel	118°	HSS	Black	DIN 1870/ 2	8,00 - 50,00	70

Articolo Article	Tipo Type	Campo d'applicazione Application field	Angolo vertice Point angle	Materiale tipo Tool material	Superficie Surface	Standard	gamma dal (mm) diameter range (mm)	pag page
 CM 307 FORI PROFONDI DEEP HOLE	S	Acciai tenaci Hardened steel	135°	HSS+5%CO	White	DIN 1870/ 2	8,00 - 30,00	70
PUNTE A GRADINO CON ELICHE INDIPENDENTI STUBLAND DRILLS WITH INDIPENDENT SPIRAL								
 CM 370	N	Acciai comuni Standard steel	118°	HSS	White	DIN 8377	M5 - M20	72
 CM 371	N	Acciai comuni Standard steel	118°	HSS	White	DIN 8375	M5 - M10	72
 CM 372	N	Acciai comuni Standard steel	118°	HSS	White	DIN 8379	M8 - M20	73





rpm
 $= (\text{m/min} \times 1000) / (D \times 3,14)$



mm/min
 $= \text{mm/rev} \times \text{rpm}$



= mt/min



= mm/rev
 (vedi tabella - see table page pag. 23)

PUNTE EXTRA CORTE TWIST DRILLS, STUB LENGHT										PUNTE CORTE TWIST DRILLS, JOBBER LENGHT	
CL100	CL101			CL118			CL104	CL104R			
HSS		HSS+8%Co			HSS+5%Co			HSS			

Pag. 378	TIPO DI ACCIAIO TYPE OF STEEL	N/mm ²	HV	mt/min mm/rev	mt/min mm/rev	mt/min mm/rev	mt/min mm/rev	mt/min mm/rev	mt/min mm/rev	mt/min mm/rev	mt/min mm/rev	mt/min mm/rev	mt/min mm/rev
ACCIAI COMUNI COMMON STEEL	Acciai teneri Soft steel	1	500	157	30 b	42 d	55 c	60 c	38 c	50 c	57 c	30 b	37 c
	Acciai da costruzione Structural steel	2	700	219	22 c	35 c	45 b	55 b	30 c	40 b	50 b	22 c	30 b
	Acciai da tempra Hardening steel	3	900	280	13 c		35 b	40 b		30 b	38 b	13 c	20 b
	Acciaio automatico Automatic steel	4	1200	373									
ACCIAI INOX STAINLESS STEEL	Acciaio automatico Automatic steel	3	850	265	17 b	26 c	32 b	36 b	22 b	28 b	34 b	17 b	22 b
	Austenitico Austenitic	3	850	265	8 c	18 d	18 c	22 c	12 c	15 c	20 c	8 c	12 c
	Ferritico+austenitico Ferritic austenitic	4	1000	311	10 b		22 c	26 c	15 b	18 c	24 c	10 b	15 b
GHISA CAST IRON	Ghisa fino a 180 hb Cast iron up to 180hb	2	500	157	30 d	38 d	45 c	48 d	36 d	42 c	45 d	30 d	37 d
	Ghisa oltre 180 hb Cast iron over 180hb	3	700	219	20 b	28 c	32 c	35 d	26 b	30 c	32 d	20 b	25 b
TITANIO TITANIUM	Titanio non legato Unalloyed titanium	5	500	157	22 b	33 d	36 d	40 d	28 c	31 c	38 d	22 b	26 b
	Leghe di titanio Titanium alloys	5	900	280	10 a	24 d	27 d	30 d	18 c	21 c	28 d	10 a	14 a
RAME COPPER	Rame Copper	9	350	110	30 c	42 d			40 c			30 c	40 c
	Ottone Brass	9	700	219	33 c	45 d	55 c		43 b	50 c		33 c	43 b
	Bronzo Bronze	9	700	219	15 c	24 d	50 c		22 b	45 c		15 c	23 b
NICHEL NICKEL	Nichel non legato Unalloyed nichel	6	700	219	10 b	18 c	22 c	26 d	16 c	20 c	24 d	10 b	16 c
	Leghe di nichel Nichel alloys	6	900	280	5 a	15 c	12 c	16 d	12 b	10 c	14 d	5 a	11 b
ALLUMINIO ALUMINIUM	Alluminio non legato Unalloyed aluminium	7	350	110	35 d	40 d	70 d		38 d	60 d		35 d	39 d
	Alluminio con leghe Alloyed aluminium	7	400	125	30 d	35 d	60 d		33 d	55 d		30 d	34 d
	Alluminio con leghe Alloyed aluminium	7	500	157	25 c	30 c	45 c		28 c	40 c		25 c	29 c

PUNTE CORTE TWIST DRILLS, JOBBER LENGTH

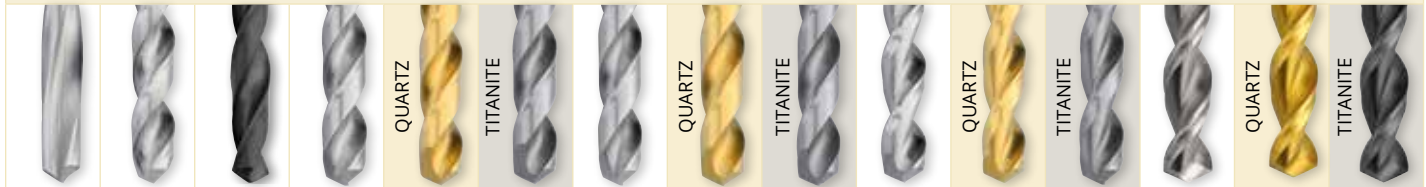

CL107 CL108 CL104CR CL106 CL105 CL109 CL119



HSS HSS+5%Co HSS+8%Co HSS+5%Co



HSS		HSS+5%Co				HSS+8%Co				HSS+5%Co					
mt/min	mm/rev	mt/min	mm/rev	mt/min	mm/rev	mt/min	mm/rev	mt/min	mm/rev	mt/min	mm/rev	mt/min	mm/rev	mt/min	mm/rev
		30 b	35 c	50 c	57 c	42 d	55 c	60 c	38 c	50 c	57 c	38 c	50 c	57 c	
		22 c	28 b	40 b	50 b	35 c	45 b	55 b	30 c	40 b	50 b	30 c	40 b	50 b	
		13 c	18 b	30 b	38 b		35 b	40 b		30 b	38 b		30 b	38 b	
		17 b	20 b	28 b	34 b	26 c	32 b	36 b	22 b	28 b	34 b	22 b	28 b	34 b	
		8 c	10 c	15 c	20 c	18 d	18 c	22 c	12 c	15 c	20 c	12 c	15 c	20 c	
		10 b	13 b	18 c	24 c		22 c	26 c	15 b	18 c	24 c	15 b	18 c	24 c	
		30 d	35 d	42 c	45 d	38 d	45 c	48 d	36 d	42 c	45 d	36 d	42 c	45 d	
		20 b	23 b	30 c	32 d	28 c	32 c	35 d	26 b	30 c	32 d	26 b	30 c	32 d	
		22 b	24 b	31 c	38 d	33 d	36 d	40 d	28 c	31 c	38 d	28 c	31 c	38 d	
		10 a	12 a	21 c	28 d	24 d	27 d	30 d	18 c	21 c	28 d	18 c	21 c	28 d	
	30 c	30 c	38 c			42 d			40 c			40 c			
33 c		33 c	41 b	50 c		45 d	55 c		43 b	50 c		43 b	50 c		
15 c		15 c	20 b	45 c		24 d	50 c		22 b	45 c		22 b	45 c		
		10 b	14 c	20 c	24 d	18 c	22 c	26 d	16 c	20 c	24 d	16 c	20 c	24 d	
		5 a	9 b	10 c	14 d	15 c	12 c	16 d	12 b	10 c	14 d	12 b	10 c	14 d	
	35 d	35 d	37 d	60 d		40 d	70 d		38 d	60 d		38 d	60 d		
	30 d	30 d	32 d	55 d		35 d	60 d		33 d	55 d		33 d	55 d		
	25 c	25 c	27 c	40 c		30 c	45 c		28 c	40 c		28 c	40 c		



$$\text{rpm} = (\text{mt/min} \times 1000) / (D \times 3,14)$$



$$\text{mm/min} = \text{mm/rev} \times \text{rpm}$$



$$= \text{mt/min}$$



$$= \text{mm/rev}$$

(vedi tabella - see table page pag. 23)

PUNTE LUNGHE TWIST DRILLS, LONG SERIES				PUNTE EXTRA LUNGHE TWIST DRILLS, EXTRA LONG SERIES					
CL200	CL230			CL111/1	CL110/1			CL111/2	
DIN 340				DIN 1869/1					DIN 1869/2
HSS		HSS+5%Co			HSS		HSS+5%Co		HSS

Pag. 378	TIPO DI ACCIAIO TYPE OF STEEL	N/mm ²	HV	mt/min mm/rev	mt/min mm/rev	mt/min mm/rev	mt/min mm/rev	mt/min mm/rev	mt/min mm/rev	mt/min mm/rev	mt/min mm/rev	mt/min mm/rev	mt/min mm/rev
ACCIAI COMUNI COMMON STEEL	Acciai teneri Soft steel	1	500	157	30 b	38 c	50 c	57 c	30 b	38 c	50 c	57 c	30 b
	Acciai da costruzione Structural steel	2	700	219	22 c	30 c	40 b	50 b	22 c	30 c	40 b	50 b	22 c
	Acciai da tempra Hardening steel	3	900	280	13 c		30 b	38 b	13 c		30 b	38 b	13 c
	Acciaio automatico Automatic steel	4	1200	373									
ACCIAI INOX STAINLESS STEEL	Acciaio automatico Automatic steel	3	850	265	17 b	22 b	28 b	34 b	17 b	22 b	28 b	34 b	17 b
	Austenitico Austenitic	3	850	265	8 c	12 c	15 c	20 c	8 c	12 c	15 c	20 c	8 c
	Ferritico+austenitico Ferritic austenitic	4	1000	311	10 b	15 b	18 c	24 c	10 b	15 b	18 c	24 c	10 b
GHISA CAST IRON	Ghisa fino a 180 hb Cast iron up to 180hb	2	500	157	30 d	36 d	42 c	45 d	30 d	36 d	42 c	45 d	30 d
	Ghisa oltre 180 hb Cast iron over 180hb	3	700	219	20 b	26 b	30 c	32 d	20 b	26 b	30 c	32 d	20 b
TITANIO TITANIUM	Titanio non legato Unalloyed titanium	5	500	157	22 b	28 c	31 c	38 d	22 b	28 c	31 c	38 d	22 b
	Leghe di titanio Titanium alloys	5	900	280	10 a	18 c	21 c	28 d	10 a	18 c	21 c	28 d	10 a
RAME COPPER	Rame Copper	9	350	110	30 c	40 c			30 c	40 c			30 c
	Ottone Brass	9	700	219	33 c	43 b	50 c		33 c	43 b	50 c		33 c
	Bronzo Bronze	9	700	219	15 c	22 b	45 c		15 c	22 b	45 c		15 c
NICHEL NICKEL	Nichel non legato Unalloyed nichel	6	700	219	10 b	16 c	20 c	24 d	10 b	16 c	20 c	24 d	10 b
	Leghe di nichel Nichel alloys	6	900	280	5 a	12 b	10 c	14 d	5 a	12 b	10 c	14 d	5 a
ALLUMINIO ALUMINIUM	Alluminio non legato Unalloyed aluminium	7	350	110	35 d	38 d	60 d		35 d	38 d	60 d		35 d
	Alluminio con leghe Alloyed aluminium	7	400	125	30 d	33 d	55 d		30 d	33 d	55 d		30 d
	Alluminio con leghe Alloyed aluminium	7	500	157	25 c	28 c	40 c		25 c	28 c	40 c		25 c

PUNTE EXTRA LUNGHE TWIST DRILLS, EXTRA LONG SERIES							PUNTE DOPPIE DOUBLE TWIST DRILLS	PUNTE PER CENTRI NC NC-SPOTTING DRILLS									
QUARTZ			TITANITE			QUARTZ			TITANITE			QUARTZ			TITANITE		
CL110/2			CL111/3			CL110/3			CL150			CL102			CL103		
DIN 1869/2			DIN 1869/3			CARMON NORM.			CARMON NORM.								
HSS+5%Co			HSS			HSS+5%Co			HSS			HSS+8% Co					
[Symbol]			[Symbol]			[Symbol]			[Symbol]			[Symbol]					
nt/min mm/rev	nt/min mm/rev	nt/min mm/rev	nt/min mm/rev	nt/min mm/rev	nt/min mm/rev	nt/min mm/rev	nt/min mm/rev	nt/min mm/rev	nt/min mm/rev	nt/min mm/rev	nt/min mm/rev	nt/min mm/rev	nt/min mm/rev	nt/min mm/rev	nt/min mm/rev	nt/min mm/rev	
38 c	50 c	57 c	30 b	38 c	50 c	57 c		35 c	50 c	57 c	35 c	50 c	57 c				
30 c	40 b	50 b	22 c	30 c	40 b	50 b		28 b	40 b	50 b	28 b	40 b	50 b				
	30 b	38 b	13 c		30 b	38 b		18 b	30 b	38 b	18 b	30 b	38 b				
22 b	28 b	34 b	17 b	22 b	28 b	34 b		20 b	28 b	34 b	20 b	28 b	34 b				
12 c	15 c	20 c	8 c	12 c	15 c	20 c		10 c	15 c	20 c	10 c	15 c	20 c				
15 b	18 c	24 c	10 b	15 b	18 c	24 c		13 b	18 c	24 c	13 b	18 c	24 c				
36 d	42 c	45 d	30 d	36 d	42 c	45 d		35 d	42 c	45 d	35 d	42 c	45 d				
26 b	30 c	32 d	20 b	26 b	30 c	32 d		23 b	30 c	32 d	23 b	30 c	32 d				
28 c	31 c	38 d	22 b	28 c	31 c	38 d		24 b	31 c	38 d	24 b	31 c	38 d				
18 c	21 c	28 d	10 a	18 c	21 c	28 d		12 a	21 c	28 d	12 a	21 c	28 d				
40 c			30 c	40 c				38 c			38 c						
43 b	50 c		33 c	43 b	50 c			41 b	50 c		41 b	50 c					
22 b	45 c		15 c	22 b	45 c			20 b	45 c		20 b	45 c					
16 c	20 c	24 d	10 b	16 c	20 c	24 d		14 c	20 c	24 d	14 c	20 c	24 d				
12 b	10 c	14 d	5 a	12 b	10 c	14 d		9 b	10 c	14 d	9 b	10 c	14 d				
38 d	60 d		35 d	38 d	60 d			37 d	60 d		37 d	60 d					
33 d	55 d		30 d	33 d	55 d			32 d	55 d		32 d	55 d					
28 c	40 c		25 c	28 c	40 c			27 c	40 c		27 c	40 c					



rpm
 $= (\text{mm/min} \times 1000) / (D \times 3,14)$



mm/min
 $= \text{mm/rev} \times \text{rpm}$





















= mt/min



= mm/rev
 (vedi tabella - see table page pag. 23)

PUNTE DA CENTRO CENTER DRILLS						PUNTE A GRADINO CON ELICHE INDIPENDENTI SUBLAND DRILLS WITH INDEPENDENT SPIRAL		
	QUARTZ		QUARTZ		QUARTZ			
CL910		CL920		CL930		CL270	CL271	CL272
HSS						HSS		

Pag. 378	TIPO DI ACCIAIO TYPE OF STEEL	N/mm ²	HV	mt/min		mm/rev		mt/min		mm/rev		mt/min		mm/rev	
				b	c	b	c	b	c	b	c	b	c		
ACCIAI COMUNI COMMON STEEL	Acciai teneri Soft steel	1	500	157	30	37	30	37	30	37	30	30	30	30	
	Acciai da costruzione Structural steel	2	700	219	22	30	22	30	22	30	22	22	22	22	
	Acciai da tempra Hardening steel	3	900	280	13	20	13	20	13	20	13	13	13	13	
	Acciaio automatico Automatic steel	4	1200	373											
ACCIAI INOX STAINLESS STEEL	Acciaio automatico Automatic steel	3	850	265	17	22	17	22	17	22	17	17	17	17	
	Austenitico Austenitic	3	850	265	8	12	8	12	8	12	8	8	8	8	
	Ferritico+austenitico Ferritic austenitic	4	1000	311	10	15	10	15	10	15	10	10	10	10	
GHISA CAST IRON	Ghisa fino a 180 hb Cast iron up to 180hb	2	500	157	30	37	30	37	30	37	30	30	30	30	
	Ghisa oltre 180 hb Cast iron over 180hb	3	700	219	20	25	20	25	20	25	20	20	20	20	
TITANIO TITANIUM	Titanio non legato Unalloyed titanium	5	500	157	22	26	22	26	22	26	22	22	22	22	
	Leghe di titanio Titanium alloys	5	900	280	10	14	10	14	10	14	10	10	10	10	
RAME COPPER	Rame Copper	9	350	110	30	40	30	40	30	40	30	30	30	30	
	Ottone Brass	9	700	219	33	43	33	43	33	43	33	33	33	33	
	Bronzo Bronze	9	700	219	15	23	15	23	15	23	15	15	15	15	
NICHEL NICKEL	Nichel non legato Unalloyed nichel	6	700	219	10	16	10	16	10	16	10	10	10	10	
	Leghe di nichel Nichel alloys	6	900	280	5	11	5	11	5	11	5	5	5	5	
ALLUMINIO ALUMINIUM	Alluminio non legato Unalloyed aluminium	7	350	110	35	39	35	39	35	39	35	35	35	35	
	Alluminio con leghe Alloyed aluminium	7	400	125	30	34	30	34	30	34	30	30	30	30	
	Alluminio con leghe Alloyed aluminium	7	500	157	25	29	25	29	25	29	25	25	25	25	

PUNTE CODOLO CONICO TAPER SHANK TWIST DRILLS				PUNTE LUNGHE CODOLO CONICO TAPER SHANK DRILLS, LONG SERIES				PUNTE EXTRA LUNGHE CODOLO CONICO TWIST DRILLS TAPER SHANK EXTRALONG					
													
CM300	CM303			CM301	CM302			CM304	CM306			CM305	CM307
DIN 345				DIN 341				DIN 1870/1				DIN 1870/2	DIN 1870/2
HSS	HSS+5% Co			HSS	HSS+5% Co			HSS	HSS+5% Co			HSS	HSS +5% Co
													
mt/min mm/rev	mt/min mm/rev	mt/min mm/rev	mt/min mm/rev	mt/min mm/rev	mt/min mm/rev	mt/min mm/rev	mt/min mm/rev	mt/min mm/rev	mt/min mm/rev	mt/min mm/rev	mt/min mm/rev	mt/min mm/rev	mt/min mm/rev
30 c	35 c	50 c	57 c	30 c	38 c	50 c	57 c	30 c	38 c	50 c	57 c	30 c	38 c
22 b	28 b	40 b	50 b	22 b	30 c	40 b	50 b	22 b	30 c	40 b	50 b	22 b	30 c
13 b	18 b	30 b	38 b	13 b		30 b	38 b	13 b		30 b	38 b	13 b	
17 b	20 b	28 b	34 b	17 b	22 b	28 b	34 b	17 b	22 b	28 b	34 b	17 b	22 b
8 c	10 c	15 c	20 c	8 c	12 c	15 c	20 c	8 c	12 c	15 c	20 c	8 c	12 c
10 b	13 b	18 c	24 c	10 b	15 b	18 c	24 c	10 b	15 b	18 c	24 c	10 b	15 b
30 d	35 d	42 c	45 d	30 d	36 d	42 c	45 d	30 d	36 d	42 c	45 d	30 d	36 d
20 b	23 b	30 c	32 d	20 b	26 b	30 c	32 d	20 b	26 b	30 c	32 d	20 b	26 b
22 b	24 b	31 c	38 d	22 b	28 c	31 c	38 d	22 b	28 c	31 c	38 d	22 b	28 c
10 a	12 a	21 c	28 d	10 a	18 c	21 c	28 d	10 a	18 c	21 c	28 d	10 a	18 c
18 c	30 c	40 c		18 c	38 c	40 c		18 c	38 c	40 c		18 c	38 c
20 c	33 c	43 b	50 c	20 c	41 b	43 b	50 c	20 c	41 b	43 b	50 c	20 c	41 b
12 c	15 c	22 b	45 c	12 c	20 b	22 b	45 c	12 c	20 b	22 b	45 c	12 c	20 b
10 b	14 c	20 c	24 d	10 b	16 c	20 c	24 d	10 b	16 c	20 c	24 d	10 b	16 c
5 a	9 b	10 c	14 d	5 a	12 b	10 c	14 d	5 a	12 b	10 c	14 d	5 a	12 b
35 d	37 d	60 d		35 d	38 d	60 d		35 d	38 d	60 d		35 d	38 d
30 d	32 d	55 d		30 d	33 d	55 d		30 d	33 d	55 d		30 d	33 d
25 c	27 c	40 c		25 c	28 c	40 c		25 c	28 c	40 c		25 c	28 c



rpm
 $= (\text{mt/min} \times 1000) / (D \times 3,14)$



mm/min
 $= \text{mm/rev} \times \text{rpm}$



= mt/min



= mm/rev
 (vedi tabella - see table page pag. 23)

PUNTE A DUE DIAMETRI SUBLAND TWIST DRILLS



Pag. 378	TIPO DI ACCIAIO TYPE OF STEEL	N/mm ²	HV	mt/min mm/rev	mt/min mm/rev	mt/min mm/rev	
ACCIAI COMUNI COMMON STEEL	Acciai teneri Soft steel	1	500	157	30 c	30 c	30 c
	Acciai da costruzione Structural steel	2	700	219	22 b	22 b	22 b
	Acciai da tempra Hardening steel	3	900	280	13 b	13 b	13 b
	Acciaio automatico Automatic steel	4	1200	373			
ACCIAI INOX STAINLESS STEEL	Acciaio automatico Automatic steel	3	850	265	17 b	17 b	17 b
	Austenitico Austenitic	3	850	265	8 c	8 c	8 c
	Ferritico+austenitico Ferritic austenitic	4	1000	311	10 b	10 b	10 b
GHISA CAST IRON	Ghisa fino a 180 hb Cast iron up to 180hb	2	500	157	30 d	30 d	30 d
	Ghisa oltre 180 hb Cast iron over 180hb	3	700	219	20 b	20 b	20 b
TITANIO TITANIUM	Titanio non legato Unalloyed titanium	5	500	157	22 b	22 b	22 b
	Leghe di titanio Titanium alloys	5	900	280	10 a	10 a	10 a
RAME COPPER	Rame Copper	9	350	110	18 c	18 c	18 c
	Ottone Brass	9	700	219	20 c	20 c	20 c
	Bronzo Bronze	9	700	219	12 c	12 c	12 c
NICHEL NICKEL	Nichel non legato Unalloyed nichel	6	700	219	10 b	10 b	10 b
	Leghe di nichel Nichel alloys	6	900	280	5 a	5 a	5 a
ALLUMINIO ALUMINIUM	Alluminio non legato Unalloyed aluminium	7	350	110	35 d	35 d	35 d
	Alluminio con leghe Alloyed aluminium	7	400	125	30 d	30 d	30 d
	Alluminio con leghe Alloyed aluminium	7	500	157	25 c	25 c	25 c

FORATURA DRILLING	TABELLA PARAMETRI DI AVANZAMENTO mm/giro RECOMMENDED FEED DATA mm/rev.																
	DIAMETRO DELLA PUNTA DRILL DIAMETER																
LETTERA DI RIFERIMENTO REFERENCE LETTER	D. 1	D. 2	D. 3	D. 4	D. 5	D. 6	D. 8	D. 10	D. 12	D. 14	D. 16	D. 20	D. 25	D. 30	D. 35	D. 40	D. 50
a	0,015	0,030	0,038	0,047	0,053	0,060	0,075	0,090	0,100	0,120	0,127	0,160	0,200	0,230	0,250	0,300	0,350
b	0,020	0,050	0,070	0,085	0,100	0,120	0,150	0,180	0,200	0,230	0,250	0,270	0,290	0,330	0,350	0,380	0,400
c	0,023	0,080	0,100	0,130	0,150	0,180	0,250	0,270	0,280	0,300	0,330	0,370	0,420	0,450	0,470	0,500	0,550
d	0,030	0,100	0,160	0,180	0,220	0,240	0,300	0,370	0,400	0,450	0,480	0,500	0,530	0,550	0,580	0,600	0,630
e	0,035	0,120	0,200	0,250	0,270	0,300	0,350	0,450	0,470	0,500	0,530	0,550	0,600	0,640	0,680	0,700	0,730
f	0,050	0,150	0,220	0,250	0,320	0,400	0,490	0,620	0,650	0,720	0,850	0,900	1,100	1,130	1,170	1,200	1,250
g	0,070	0,160	0,250	0,270	0,360	0,470	0,620	0,830	0,900	0,950	1,100	1,200	1,280	1,330	1,400	1,470	1,520
h	0,090	0,200	0,270	0,300	0,400	0,520	0,750	1,000	1,100	1,200	1,300	1,350	1,430	1,500	1,650	1,700	1,800

CL 100



STANDARD



CL 101



DIN 1412 C

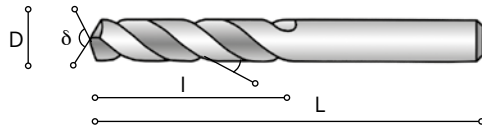

Dal Ø 1 al Ø 6 = 10 pz
Dal Ø 6,1 al Ø 13 = 5 pz
Dal Ø 13,25 al Ø 31 = 1 pz

CL100



CL101



D h8	L	l	CODE	HSS 5100..... €	HSS+8%Co 5101..... €	HSS+8%Co 6101..... € QUARTZ	HSS+8%Co 7101..... € TITANITE
1	26	600100	1,93	3,15	5,25	6,62
1,1	28	700110	2,12	3,15	5,25	6,62
1,2	30	800120	2,12	3,15	5,25	6,62
1,25	30	800125	1,97	3,15	5,25	6,62
1,3	30	800130	2,23	3,15	5,25	6,62
1,4	32	900140	2,23	3,15	5,25	6,62
1,5	32	900150	1,34	2,52	4,56	5,94
1,6	34	900160	1,64	2,81	4,87	6,23
1,7	34	1000170	1,64	2,81	4,87	6,23
1,75	36	1100175	1,42	2,81	4,87	6,23
1,8	36	1100180	1,64	2,81	4,87	6,23
1,9	36	1100190	1,64	2,81	4,87	6,23
2	38	1200200	1,41	2,00	4,10	5,23
2,1	38	1200210	1,46	2,18	4,38	5,88
2,2	40	1300220	1,46	2,18	4,38	5,88
2,25	40	1300225	1,42	2,40	4,62	6,09
2,3	40	1300230	1,59	2,41	4,64	6,12
2,4	43	1400240	1,66	2,57	4,81	6,32
2,5	43	1400250	1,50	2,43	4,65	6,13
2,6	43	1400260	1,66	2,57	4,81	6,32
2,7	46	1600270	1,66	2,57	4,81	6,32
2,75	46	1600275	1,59	2,56	4,79	6,29
2,8	46	1600280	1,71	2,57	4,81	6,32
2,9	46	1600290	1,71	2,57	4,81	6,32
3	46	1600300	1,50	2,31	4,53	6,02
3,1	49	1800310	1,67	2,41	4,64	6,12
3,2	49	1800320	1,59	2,55	4,98	6,63
3,25	49	1800325	1,50	2,47	4,76	6,29
3,3	49	1800330	1,59	2,48	4,78	6,32
3,4	52	2000340	1,82	2,85	5,16	6,67
3,5	52	2000350	1,59	2,66	4,97	6,53
3,6	52	2000360	1,82	3,15	5,70	7,37
3,7	52	2000370	1,82	3,15	5,70	7,37
3,75	52	2000375	2,05	3,14	5,67	7,34
3,8	55	2200380	1,98	3,15	5,70	7,37
3,9	55	2200390	1,98	3,15	5,70	7,37
4	55	2200400	1,75	3,14	5,67	7,34
4,1	55	2200410	1,92	3,15	6,50	8,82
4,2	55	2200420	1,92	3,15	6,50	8,82
4,25	55	2200425	1,92	3,20	6,20	8,26

D h8	L	I	CODE	HSS 5100..... €	HSS+8%Co 5101..... €	HSS+8%Co 6101..... € QUARTZ	HSS+8%Co 7101..... € TITANITE
4,3	58	2400430	3,23	4,74	7,91	9,98
4,4	58	2400440	3,23	4,74	7,91	9,98
4,5	58	2400450	1,92	3,20	6,20	8,26
4,6	58	2400460	3,23	4,74	7,91	9,98
4,7	58	2400470	3,23	4,74	7,91	9,98
4,75	58	2400475	2,33	3,84	6,89	8,95
4,8	62	2600480	3,00	5,14	8,34	10,42
4,9	62	2600490	3,30	5,14	8,34	10,42
5	62	2600500	2,33	3,84	6,89	8,95
5,1	62	2600510	3,30	5,04	8,18	10,22
5,2	62	2600520	3,30	5,04	8,18	10,22
5,25	62	2600525	2,83	4,57	7,66	9,69
5,3	62	2600530	3,30	5,04	8,18	10,22
5,4	66	2800540	4,49	6,85	10,18	12,21
5,5	66	2800550	2,83	4,57	7,66	9,69
5,6	66	2800560	4,49	6,85	10,18	12,21
5,7	66	2800570	4,49	6,85	10,18	12,21
5,75	66	2800575	3,09	4,74	7,91	9,98
5,8	66	2800580	4,49	6,85	10,18	12,21
5,9	66	2800590	4,49	6,85	10,18	12,21
6	66	2800600	3,09	4,65	7,75	9,78
6,1	70	3100610	4,65	7,08	10,93	13,33
6,2	70	3100620	4,65	7,08	10,93	13,33
6,25	70	3100625	3,15	5,29	8,96	11,36
6,3	70	3100630	4,65	7,08	10,93	13,33
6,4	70	3100640	4,89	7,32	11,20	13,60
6,5	70	3100650	3,15	5,29	8,96	11,36
6,6	70	3100660	4,89	7,32	11,20	13,60
6,7	70	3100670	4,89	7,32	11,20	13,60
6,75	74	3400675	3,78	6,53	10,33	12,73
6,8	74	3400680	5,59	8,42	12,41	14,80
6,9	74	3400690	5,59	8,42	12,41	14,80
7	74	3400700	3,78	6,53	10,33	12,73
7,1	74	3400710	6,93	10,31	14,48	16,87
7,2	74	3400720	6,93	10,31	14,48	16,87
7,25	74	3400725	4,17	7,00	10,84	13,24
7,3	74	3400730	6,93	10,31	14,48	16,87
7,4	74	3400740	6,93	10,31	14,48	16,87
7,5	74	3400750	4,40	7,00	10,84	13,24
7,6	79	3700760	8,35	12,60	17,83	20,89
7,7	79	3700770	8,35	12,60	17,83	20,89
7,75	79	3700775	4,83	7,72	12,47	15,53
7,8	79	3700780	8,35	12,60	17,83	20,89
7,9	79	3700790	8,35	12,60	17,83	20,89
8	79	3700800	4,83	7,72	12,47	15,53
8,1	79	3700810	8,58	12,99	19,03	22,70
8,2	79	3700820	8,58	12,99	19,03	22,70
8,25	79	3700825	6,31	10,63	16,43	20,10
8,3	79	3700830	8,58	12,99	19,03	22,70
8,4	79	3700840	8,58	12,99	19,03	22,70
8,5	79	3700850	6,31	10,63	16,43	20,10
8,6	84	4000860	8,90	13,47	19,54	23,22
8,7	84	4000870	8,90	13,47	19,54	23,22
8,75	84	4000875	6,31	10,63	16,43	20,10
8,8	84	4000880	8,90	13,47	19,54	23,22
8,9	84	4000890	8,90	13,47	19,54	23,22
9	84	4000900	6,31	10,63	16,43	20,10
9,1	84	4000910	11,88	17,62	24,11	27,80
9,2	84	4000920	11,88	17,62	24,11	27,80
9,25	84	4000925	9,45	15,73	22,03	25,72

CL 100



STANDARD



CL 101



DIN 1412 C

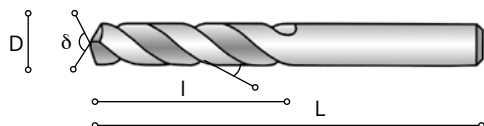

CL100



CL101



Dal Ø 1 al Ø 6 = 10 pz
Dal Ø 6,1 al Ø 13 = 5 pz
Dal Ø 13,25 al Ø 31 = 1 pz

D h8	L	l	CODE	HSS 5100..... €	HSS+8%Co 5101..... €	HSS+8%Co 6101..... € QUARTZ	HSS+8%Co 7101..... € TITANITE
9,3	84	4000930	11,88	17,62	24,11	27,80
9,4	84	4000940	11,88	17,62	24,11	27,80
9,5	84	4000950	9,45	15,73	22,03	25,72
9,6	89	4300960	15,03	21,01	27,83	31,51
9,7	89	4300970	15,03	21,01	27,83	31,51
9,75	89	4300975	9,45	18,33	24,90	28,58
9,8	89	4300980	15,03	21,01	27,83	31,51
9,9	89	4300990	15,03	21,01	27,83	31,51
10	89	4301000	7,55	12,83	18,83	22,52
10,25	89	4301025	12,44	20,46	27,23	30,91
10,5	89	4301050	12,44	20,46	27,23	30,91
10,75	95	4701075	12,44	20,46	27,23	30,91
11	95	4701100	12,44	20,46	27,23	30,91
11,25	95	4701125	12,83	21,33	28,18	31,87
11,5	95	4701150	12,83	21,33	28,18	31,87
11,75	95	4701175	16,93	25,96	33,30	36,97
12	102	5101200	16,93	25,96	34,64	39,34
12,25	102	5101225	17,25	26,91	36,41	41,67
12,5	102	5101250	17,25	26,91	36,41	41,67
12,75	102	5101275	17,25	26,91	36,41	41,67
13	102	5101300	17,25	26,91	36,41	41,67
13,25	107	5401325		32,50	42,68	48,03
13,5	107	5401350		31,01	41,06	46,41
13,75	107	5401375		31,01	41,06	46,41
14	107	5401400		31,01	41,06	46,41
14,25	111	5601425		35,57	46,06	51,41
14,5	111	5601450		33,95	44,27	49,63
14,75	111	5601475		33,95	44,27	49,63
15	111	5601500		33,95	44,27	49,63
15,25	115	5801525		44,12	55,66	61,18
15,5	115	5801550		42,11	53,45	58,97
15,75	115	5801575		44,12	55,66	61,18
16	115	5801600		42,11	53,45	58,97
16,25	119	6001625		47,93	60,79	67,00
16,5	119	6001650		47,93	60,79	67,00
16,75	119	6001675		47,93	60,79	67,00
17	119	6001700		47,19	59,98	66,20
17,25	123	6201725		53,62	67,04	73,26
17,5	123	6201750		53,62	67,04	73,26
17,75	123	6201775		53,62	67,04	73,26

D h8	L	I	CODE	HSS 5100..... €	HSS+8%Co 5101..... €	HSS+8%Co 6101..... € QUARTZ	HSS+8%Co 7101..... € TITANITE
18	123	6201800		51,47	64,68	70,89
18,25	127	6401825		58,66	74,53	82,25
18,5	127	6401850		58,66	74,53	82,25
18,75	127	6401875		58,66	74,53	82,25
19	127	6401900		57,08	72,80	80,52
19,25	131	6601925		65,08	81,59	89,31
19,5	131	6601950		66,38	83,22	91,10
19,75	131	6601975		66,38	83,22	91,10
20	131	6602000		61,17	77,50	85,37
20,5	136	6802050		77,96	95,76	103,48
21	136	6802100		75,54	93,32	101,19
21,5	141	7002150		77,96	100,71	112,25
22	141	7002200		79,34	102,24	113,79
22,5	146	7202250		95,84	130,90	150,42
23	146	7202300		95,31	130,32	149,84
23,5	146	7202350		107,85	144,11	163,63
24	151	7502400		89,99	125,23	145,33
24,5	151	7502450		114,75	151,71	171,23
25	151	7502500		105,41	141,94	161,85
26	156	7802600		123,40	168,68	194,07
27	162	8102700		145,52	192,99	218,38
28	162	8102800		145,52	192,99	218,38
29	168	8402900		158,74	207,55	232,93
30	168	8403000		158,74	207,55	232,93
31	174	8703100		211,65	269,41	297,66

CL 118

ACCIAIO INOX
STAINLESS STEEL

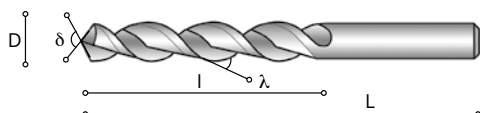

CL118



Dal \varnothing 1 al \varnothing 6 = 10 pz
Dal \varnothing 6,1 al \varnothing 13 = 5 pz
Dal \varnothing 13,25 al \varnothing 31 = 1 pz

D h8	L	l	CODE	HSS+5%Co 5118..... €	HSS+5%Co 6118..... € QUARTZ	HSS+5%Co 7118..... € TITANITE
2	38	1200200	2,26	3,26	4,16
2,1	38	1200210	2,31	3,48	4,68
2,2	40	1300220	2,54	3,81	5,12
2,25	40	1300225	2,54	3,85	5,09
2,3	40	1300230	2,57	4,10	5,42
2,4	43	1400240	2,57	4,26	5,59
2,5	43	1400250	2,35	3,67	4,83
2,6	43	1400260	2,49	3,84	5,03
2,7	46	1600270	2,49	3,84	5,03
2,75	46	1600275	2,57	3,78	4,96
2,8	46	1600280	2,49	3,84	5,03
2,9	46	1600290	2,49	3,84	5,03
3	46	1600300	2,47	3,56	4,74
3,1	49	1800310	2,65	3,69	4,87
3,2	49	1800320	2,68	3,97	5,28
3,25	49	1800325	2,74	3,75	4,96
3,3	49	1800330	2,65	3,81	5,03
3,4	52	2000340	2,65	4,10	5,31
3,5	52	2000350	2,91	3,92	5,15
3,6	52	2000360	3,12	4,54	5,88
3,7	52	2000370	3,12	4,54	5,88
3,75	52	2000375	3,27	4,54	5,88
3,8	55	2200380	3,12	4,54	5,88
3,9	55	2200390	3,45	5,03	6,51
4	55	2200400	3,20	4,47	5,79
4,1	55	2200410	3,50	5,25	7,13
4,2	55	2200420	3,50	5,25	7,13
4,25	55	2200425	3,64	4,95	6,60
4,3	58	2400430	3,72	6,20	7,83
4,4	58	2400440	3,72	6,20	7,83
4,5	58	2400450	3,48	4,89	6,51
4,6	58	2400460	3,78	6,29	7,95
4,7	58	2400470	3,78	6,29	7,95
4,75	58	2400475	3,94	5,51	7,17
4,8	62	2600480	4,04	6,54	8,17
4,9	62	2600490	4,04	6,54	8,17
5	62	2600500	3,72	5,43	7,06
5,1	62	2600510	4,37	7,08	8,84
5,2	62	2600520	4,37	7,08	8,84
5,25	62	2600525	4,36	6,12	7,75

D h8	L	I	CODE	HSS+5%Co 5118..... €	HSS+5%Co 6118..... € QUARTZ	HSS+5%Co 7118..... € TITANITE
5,3	62	2600530	4,37	7,08	8,84
5,4	66	2800540	5,48	8,14	9,77
5,5	66	2800550	4,29	6,12	7,75
5,6	66	2800560	5,48	8,14	9,77
5,7	66	2800570	5,48	8,14	9,77
5,75	66	2800575	4,81	6,32	7,99
5,8	66	2800580	5,48	8,14	9,77
5,9	66	2800590	5,48	8,14	9,77
6	66	2800600	5,12	6,20	7,83
6,1	70	3100610	5,66	8,75	10,66
6,2	70	3100620	5,66	8,75	10,66
6,25	70	3100625	5,49	7,32	9,27
6,3	70	3100630	5,66	8,75	10,66
6,4	70	3100640	5,86	8,96	10,88
6,5	70	3100650	5,35	7,48	9,48
6,6	70	3100660	5,95	9,09	11,04
6,7	70	3100670	5,95	9,09	11,04
6,75	74	3400675	6,03	8,54	10,52
6,8	74	3400680	6,84	10,07	12,02
6,9	74	3400690	6,84	10,07	12,02
7	74	3400700	6,03	8,96	11,03
7,1	74	3400710	7,11	11,58	13,50
7,2	74	3400720	7,11	11,58	13,50
7,25	74	3400725	6,63	8,68	10,59
7,3	74	3400730	7,11	11,58	13,50
7,4	74	3400740	7,11	11,58	13,50
7,5	74	3400750	6,47	8,68	10,59
7,6	79	3700760	8,20	14,27	16,72
7,7	79	3700770	8,20	14,27	16,72
7,75	79	3700775	7,80	9,98	12,42
7,8	79	3700780	8,20	14,27	16,72
7,9	79	3700790	8,20	14,27	16,72
8	79	3700800	7,43	9,98	12,42
8,1	79	3700810	9,12	15,22	18,16
8,2	79	3700820	9,12	15,22	18,16
8,25	79	3700825	8,69	13,14	16,08
8,3	79	3700830	9,12	15,22	18,16
8,4	79	3700840	9,12	15,22	18,16
8,5	79	3700850	8,13	13,14	16,08
8,6	84	4000860	9,89	15,63	18,58
8,7	84	4000870	9,89	15,63	18,58
8,75	84	4000875	9,10	13,14	16,08
8,8	84	4000880	9,89	15,63	18,58
8,9	84	4000890	9,89	15,63	18,58
9	84	4000900	8,80	13,40	16,40
9,1	84	4000910	11,63	19,29	22,24
9,2	84	4000920	11,63	19,29	22,24
9,25	84	4000925	10,82	17,63	20,58
9,3	84	4000930	11,63	19,29	22,24
9,4	84	4000940	11,63	19,29	22,24
9,5	84	4000950	10,40	17,63	20,58
9,6	89	4300960	13,14	22,27	25,21
9,7	89	4300970	13,14	22,27	25,21
9,75	89	4300975	12,03	19,92	22,86
9,8	89	4300980	13,14	22,27	25,21
9,9	89	4300990	13,14	22,27	25,21
10	89	4301000	11,41	15,07	18,02
10,1	89	4301010	14,18	22,06	25,04
10,2	89	4301020	14,18	22,06	25,04
10,25	89	4301025	14,00	21,79	24,73

CL 118

ACCIAIO INOX
STAINLESS STEEL

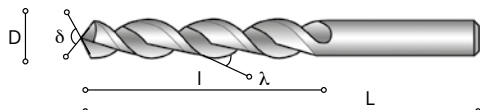

CL118



Dal \varnothing 1 al \varnothing 6 = 10 pz
Dal \varnothing 6,1 al \varnothing 13 = 5 pz
Dal \varnothing 13,25 al \varnothing 31 = 1 pz

D h8	L	l	CODE	HSS+5%Co 5118..... €	HSS+5%Co 6118..... € QUARTZ	HSS+5%Co 7118..... € TITANITE
10,3	89	4301030	14,18	25,09	28,48
10,4	89	4301040	14,18	25,09	28,48
10,5	89	4301050	12,31	21,79	24,73
10,6	89	4301060	14,85	26,28	29,82
10,7	95	4701070	14,85	26,28	29,82
10,75	95	4701075	16,37	21,79	24,73
10,8	95	4701080	14,85	24,76	28,12
10,9	95	4701090	14,85	24,76	28,12
11	95	4701100	13,06	21,79	24,73
11,1	95	4701110	15,87	26,47	27,40
11,2	95	4701120	15,87	26,47	27,40
11,25	95	4701125	16,65	22,55	25,49
11,3	95	4701130	15,87	24,24	27,40
11,4	95	4701140	15,87	24,24	27,40
11,5	95	4701150	14,76	22,55	25,49
11,6	95	4701160	16,23	24,83	27,55
11,7	95	4701170	16,23	24,83	27,55
11,75	95	4701175	17,42	26,64	29,58
11,8	95	4701180	16,23	27,36	31,08
11,9	102	5101190	16,23	27,36	31,08
12	102	5101200	16,44	27,72	31,48
12,1	102	5101210	17,49	26,47	30,28
12,2	102	5101220	17,49	26,47	30,28
12,25	102	5101225	18,97	28,70	32,83
12,3	102	5101230	17,49	28,64	32,77
12,4	102	5101240	17,49	28,64	32,77
12,5	102	5101250	17,53	28,70	32,83
12,6	102	5101260	18,97	27,66	31,65
12,7	102	5101270	18,97	27,66	31,65
12,75	102	5101275	19,69	28,70	32,83
12,8	102	5101280	18,97	29,67	33,94
12,9	102	5101290	18,97	29,67	33,94
13	102	5101300	18,35	28,70	32,83
13,5	107	5401350	19,69	33,01	37,30
14	107	5401400	20,64	33,01	37,30
14,5	111	5601450	22,43	32,90	39,90
15	111	5601500	23,65	32,90	39,90
15,5	115	5801550	25,78	42,97	47,41
16	115	5801600	26,49	42,97	47,41

CL 104



25°-30°



STANDARD



CL 104R



25°-30°



DIN 1412 C



CL 107

OTTONE-BRONZO
BRASS-BRONZE



12°-15°



STANDARD



CL 108

ALLUMINIO
ALUMINIUM



35°-40°



STANDARD

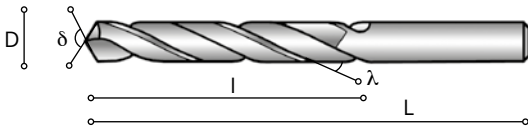

CL104



CL104R



CL107



CL108



Dal Ø 0,3 al Ø 6 = 10 pz
Dal Ø 6,1 al Ø 13 = 5 pz
Dal Ø 13,25 al Ø 20 = 1 pz

D h8	L	l	CODE	HSS 5104..... €	HSS 6104..... € QUARTZ	HSS 5107..... €	HSS 5108..... €
0,3	19	300030	4,65			
0,35	19	400035	3,87			
0,4	20	500040	3,23			
0,45	20	500045	3,23			
0,5	22	600050	3,23			
0,55	24	700055	3,23			
0,6	24	700060	3,23			
0,65	26	800065	2,68			
0,7	28	900070	2,60			
0,75	28	900075	2,60			
0,8	30	1000080	2,46			
0,85	30	1000085	2,46			
0,9	32	1100090	2,46			
0,95	32	1100095	2,46			
1	34	1200100	1,59	1,83		
1,05	34	1200105	1,59			
1,1	36	1400110	1,59	1,83		
1,15	36	1400115	1,66			
1,2	38	1600120	1,74	1,89		
1,25	38	1600125	1,27	1,89		
1,3	38	1600130	1,42	1,89		
1,35	40	1800135	1,51			
1,4	40	1800140	1,42	1,89		
1,45	40	1800145	1,51			
1,5	40	1800150	1,27	1,83	3,76	3,54
1,55	43	2000155	1,51			
1,6	43	2000160	1,34	1,97	3,76	3,54
1,65	43	2000165	1,51			
1,7	43	2000170	1,34	1,97	3,76	3,54
1,75	46	2200175	1,11	1,97		

CL 104



STANDARD



CL 104R



DIN 1412 C



CL 107

OTTONE-BRONZO
BRASS-BRONZE



STANDARD



CL 108

ALLUMINIO
ALUMINIUM



STANDARD

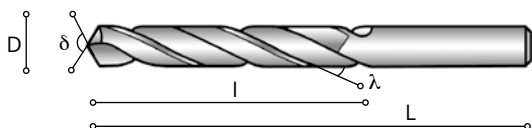

Dal \varnothing 0,3 al \varnothing 6 = 10 pz
Dal \varnothing 6,1 al \varnothing 13 = 5 pz
Dal \varnothing 13,25 al \varnothing 20 = 1 pz

CL104



CL104R



CL107



CL108



D h8	L	l	CODE	HSS 5104..... €	HSS 6104..... € QUARTZ	HSS 5107..... €	HSS 5108..... €
1,8	46	2200180	1,27	1,86	3,76	3,54
1,85	46	2200185	1,34			
1,9	46	2200190	1,27	1,86	3,76	3,54
1,95	49	2400195	1,34			
2	49	2400200	1,11	1,71	3,44	3,37
2,05	49	2400205	1,42			
2,1	49	2400210	1,27	1,93	3,44	3,37
2,15	53	2700215	1,51			
2,2	53	2700220	1,27	1,93	3,44	3,37
2,25	53	2700225	1,42	1,89		
2,3	53	2700230	1,27	1,93	3,44	3,37
2,35	53	2700235	1,42			
2,4	57	3000240	1,42	1,93	3,77	3,69
2,45	57	3000245	1,66			
2,5	57	3000250	1,42	1,89	3,52	3,46
2,55	57	3000255	1,66			
2,6	57	3000260	1,51	2,20	3,77	3,69
2,65	57	3000265	1,66			
2,7	61	3300270	1,42	2,20	3,93	3,85
2,75	61	3300275	1,42	2,02		
2,8	61	3300280	1,42	2,16	3,93	3,85
2,85	61	3300285	1,74			
2,9	61	3300290	1,42	2,16	3,93	3,85
2,95	61	3300295	1,66			
3	61	3300300	1,42	1,93	3,93	3,85
3,05	65	3600305	1,82			
3,1	65	3600310	1,66	2,61	4,10	4,02
3,15	65	3600315	1,82			
3,2	65	3600320	1,47	2,61	4,10	4,02
3,25	65	3600325	1,59	2,61		
3,3	65	3600330	1,66	2,61	4,10	4,02
3,35	65	3600335	1,82			
3,4	70	3900340	1,66	2,61	4,35	4,25
3,45	70	3900345	1,98			

D h8	L	I	CODE	HSS 5104..... €	HSS 6104..... € QUARTZ	HSS 5107..... €	HSS 5108..... €
3,5	70	3900350	1,66	2,31	4,35	4,25
3,55	70	3900355	1,98			
3,6	70	3900360	1,74	2,83	4,42	4,34
3,65	70	3900365	1,98			
3,7	70	3900370	1,74	2,83	4,42	4,34
3,75	70	3900375	1,89	2,88		
3,8	75	4300380	1,74	2,98	4,67	4,59
3,85	75	4300385	2,20			
3,9	75	4300390	1,98	2,98	4,67	4,59
3,95	75	4300395	2,20			
4	75	4300400	1,89	2,61	4,67	4,59
4,05	75	4300405	2,20			
4,1	75	4300410	2,06	3,14	4,75	4,67
4,15	75	4300415	2,20			
4,2	75	4300420	2,14	3,14	4,98	4,67
4,25	75	4300425	2,14	3,10		
4,3	80	4700430	2,14	3,34	5,73	5,63
4,35	80	4700435	2,60			
4,4	80	4700440	2,14	3,42	5,73	5,63
4,45	80	4700445	2,60			
4,5	80	4700450	2,06	2,95	5,73	5,63
4,55	80	4700455	2,60			
4,6	80	4700460	2,20	3,49	6,02	5,79
4,65	80	4700465	2,60			
4,7	80	4700470	2,20	3,49	6,02	5,79
4,75	80	4700475	2,28	3,49		
4,8	86	5200480	2,28	3,49	6,02	5,79
4,85	86	5200485	3,39			
4,9	86	5200490	2,28	3,49	6,02	5,79
4,95	86	5200495	3,39			
5	86	5200500	2,20	3,27	6,02	5,79
5,05	86	5200505	3,39			
5,1	86	5200510	2,52	4,54	6,53	6,12
5,15	86	5200515	4,10			
5,2	86	5200520	2,52	4,54	6,53	6,12
5,25	86	5200525	3,00	4,44		
5,3	86	5200530	2,62	4,54	6,53	6,12
5,35	93	5700535	4,10			
5,4	93	5700540	3,00	4,54	7,63	7,63
5,45	93	5700545	4,10			
5,5	93	5700550	3,00	4,21	7,30	7,30
5,55	93	5700555	4,25			
5,6	93	5700560	3,00	4,72	8,42	7,87
5,65	93	5700565	4,25			
5,7	93	5700570	3,00	4,72	8,42	7,87
5,75	93	5700575	3,00	4,72		
5,8	93	5700580	3,00	4,72	8,42	7,87
5,85	93	5700585	4,25			
5,9	93	5700590	3,00	4,72	8,42	7,87
5,95	93	5700595	3,00			
6	93	5700600	3,00	4,22	7,98	7,48
6,05	101	6300605	4,42			
6,1	101	6300610	3,47	5,57	9,01	8,44
6,15	101	6300615	4,42			
6,2	101	6300620	3,47	5,57	9,01	8,44
6,25	101	6300625	3,70	5,57		
6,3	101	6300630	3,47	5,57	9,01	8,44
6,35	101	6300635	3,47			
6,4	101	6300640	3,70	5,57	9,61	9,00
6,45	101	6300645	5,67			

CL 104



STANDARD



CL 104R



DIN 1412 C



CL 107

OTTONE-BRONZO
BRASS-BRONZE



STANDARD



CL 108

ALLUMINIO
ALUMINIUM



STANDARD

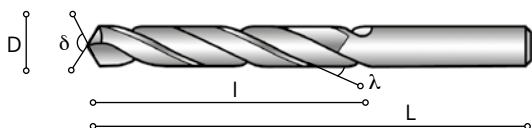

Dal \varnothing 0,3 al \varnothing 6 = 10 pz
Dal \varnothing 6,1 al \varnothing 13 = 5 pz
Dal \varnothing 13,25 al \varnothing 20 = 1 pz

CL104



CL104R



CL107



CL108



D h8	L	l	CODE	HSS 5104..... €	HSS 6104..... € QUARTZ	HSS 5107..... €	HSS 5108..... €
6,5	101	6300650	3,62	5,16	9,45	8,84
6,55	101	6300655	5,67			
6,6	101	6300660	3,70	6,39	9,86	9,23
6,65	101	6300665	5,67			
6,7	101	6300670	3,70	6,39	9,86	9,23
6,75	109	6900675	4,42	6,39		
6,8	109	6900680	4,17	6,39	9,86	9,23
6,85	109	6900685	6,77			
6,9	109	6900690	4,65	6,39	9,86	9,23
6,95	109	6900695	6,77			
7	109	6900700	4,34	6,15	9,69	9,08
7,05	109	6900705	7,25			
7,1	109	6900710	4,81	7,28	13,09	13,09
7,15	109	6900715	7,25			
7,2	109	6900720	4,97	7,28	13,09	13,09
7,25	109	6900725	4,57	7,01		
7,3	109	6900730	4,97	7,34	13,09	13,09
7,35	109	6900735	7,25			
7,4	109	6900740	4,97	7,34	13,09	13,09
7,45	109	6900745	5,99			
7,5	109	6900750	4,49	6,46	10,87	10,67
7,55	117	7500755	8,58			
7,6	117	7500760	5,36	8,34	14,60	14,60
7,65	117	7500765	8,58			
7,7	117	7500770	5,36	8,34	14,60	14,60
7,75	117	7500775	5,36	8,18		
7,8	117	7500780	5,36	8,18	14,60	14,60
7,85	117	7500785	8,58			
7,9	117	7500790	5,36	8,18	13,01	14,60
7,95	117	7500795	8,58			
8	117	7500800	4,81	7,23	12,01	11,24
8,1	117	7500810	5,76	8,73	15,33	15,33
8,2	117	7500820	5,76	8,73	15,33	15,33
8,25	117	7500825	5,59	8,51		

D h8	L	I	CODE	HSS 5104..... €	HSS 6104..... € QUARTZ	HSS 5107..... €	HSS 5108..... €
8,3	117	7500830	5,76	8,73	15,33	15,33
8,4	117	7500840	5,76	8,73	15,33	15,33
8,5	117	7500850	5,52	7,85	12,69	11,88
8,6	125	8100860	6,93	10,61	17,97	17,97
8,7	125	8100870	6,93	10,61	17,97	17,97
8,75	125	8100875	6,93	10,66		
8,8	125	8100880	6,93	10,82	17,97	17,97
8,9	125	8100890	6,93	10,82	17,97	17,97
9	125	8100900	6,77	9,74	13,72	12,85
9,1	125	8100910	7,00	11,99	20,39	20,39
9,2	125	8100920	7,00	11,99	20,39	20,39
9,25	125	8100925	7,48	11,39		
9,3	125	8100930	7,48	11,99	20,39	20,39
9,4	125	8100940	7,48	11,99	20,39	20,39
9,5	125	8100950	7,40	10,68	15,19	14,22
9,6	133	8700960	7,87	13,05	22,79	22,79
9,7	133	8700970	7,87	13,05	22,79	22,79
9,75	133	8700975	8,19	12,75		
9,8	133	8700980	8,19	12,79	22,79	22,79
9,9	133	8700990	8,19	12,79	22,79	22,79
10	133	8701000	8,03	11,46	16,45	16,14
10,1	133	8701010	8,58	15,71		
10,2	133	8701020	8,58	15,71		
10,25	133	8701025	10,31	16,99		
10,3	133	8701030	11,73	16,99		
10,4	133	8701040	11,73	16,99		
10,5	133	8701050	10,23	14,39	22,19	21,76
10,6	133	8701060	11,73	18,13		
10,7	142	9401070	14,31	18,13		
10,75	142	9401075	13,30	17,28		
10,8	142	9401080	14,31	19,24		
10,9	142	9401090	14,31	19,24		
11	142	9401100	11,88	16,66	22,87	22,87
11,1	142	9401110	15,26	20,15		
11,2	142	9401120	15,11	20,15		
11,25	142	9401125	13,94	18,58		
11,3	142	9401130	15,26	20,15		
11,4	142	9401140	15,26	20,15		
11,5	142	9401150	12,44	17,51	27,59	25,83
11,6	142	9401160	15,26	22,03		
11,7	142	9401170	15,26	22,03		
11,75	142	9401175	14,08	21,61		
11,8	142	9401180	15,26	22,03		
11,9	151	10101190	17,25	22,03		
12	151	10101200	13,69	19,33	28,53	26,71
12,1	151	10101210	17,16	24,13		
12,2	151	10101220	18,41	24,13		
12,25	151	10101225	15,35	24,07		
12,3	151	10101230	15,35	24,13		
12,4	151	10101240	18,41	24,13		
12,5	151	10101250	15,11	20,79	29,69	30,50
12,6	151	10101260	18,41	25,32		
12,7	151	10101270	15,58	25,32		
12,75	151	10101275	15,58	24,17		
12,8	151	10101280	18,09	25,32		
12,9	151	10101290	21,87	25,32		
13	151	10101300	14,71	21,96	28,98	29,69
13,25	160	10801325	23,76	40,10		
13,5	160	10801350	19,36	40,10		
13,75	160	10801375	23,76	40,41		

CL 104



STANDARD



CL 104R



DIN 1412 C



CL 107

OTTONE-BRONZO
BRASS-BRONZE



STANDARD



CL 108

ALLUMINIO
ALUMINIUM



STANDARD

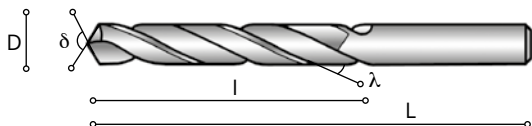

Dal \varnothing 0,3 al \varnothing 6 = 10 pz
Dal \varnothing 6,1 al \varnothing 13 = 5 pz
Dal \varnothing 13,25 al \varnothing 20 = 1 pz

CL104



CL104R



CL107



CL108



D h8	L	I	CODE	HSS 5104..... €	HSS 6104..... € QUARTZ	HSS 5107..... €	HSS 5108..... €
14	160	10801400	19,36	40,41		
14,25	169	11401425	25,96	51,13		
14,5	169	11401450	22,51	51,13		
14,75	169	11401475	25,96	52,17		
15	169	11401500	22,51	52,17		
15,25	178	12001525	37,13	57,40		
15,5	178	12001550	26,51	57,40		
15,75	178	12001575	37,13	62,82		
16	178	12001600	28,17	62,82		
16,25	184	12501625	52,87	68,56		
16,5	184	12501650	30,84	68,56		
16,75	184	12501675	54,68	69,54		
17	184	12501700	30,84	69,54		
17,25	191	13001725	58,69	75,88		
17,5	191	13001750	34,85	75,88		
17,75	191	13001775	58,69	82,74		
18	191	13001800	34,85	82,74		
18,25	198	13501825	62,16	92,27		
18,5	198	13501850	40,51	92,27		
18,75	198	13501875	62,16	92,52		
19	198	13501900	40,51	92,52		
19,25	205	14001925	79,76	102,32		
19,5	205	14001950	44,07	102,32		
19,75	205	14001975	79,76	102,97		
20	205	14002000	47,92	102,97		

CL 104 CR 



STANDARD

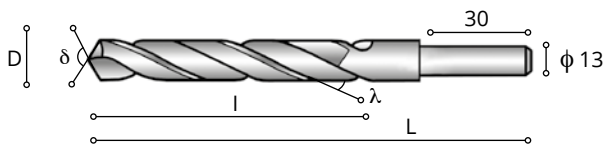

CL 104CR



A richiesta anche con codolo ridotto diam 10 x 30 mm di lunghezza. Con quantità min 10pz il prezzo è uguale al diam. 13x30
 On request also with reduced shank diam 10 x 30 mm length. With Min quantity of 10 pcs the price will be the same as per diam 13x30

D h8	L	I	CODE	HSS 5104..... €
13,5	160	10801350R	23,84
14	160	10801400R	23,84
14,5	169	11401450R	26,99
15	169	11401500R	26,99
15,5	178	12001550R	31,00
16	178	12001600R	32,65
16,5	184	12501650R	35,32
17	184	12501700R	35,32
17,5	191	13001750R	39,34
18	191	13001800R	39,34
18,5	198	13501850R	44,99
19	198	13501900R	44,99
19,5	205	14001950R	48,55
20	205	14002000R	52,40

CL 106



CL 105

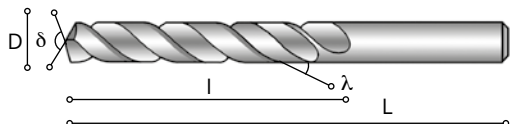

Dal \varnothing 0,3 al \varnothing 6 = 10 pz
Dal \varnothing 6,1 al \varnothing 13 = 5 pz
Dal \varnothing 13,25 al \varnothing 20 = 1 pz

CL106

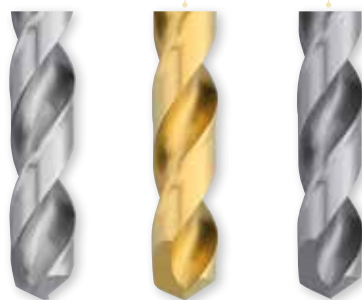

CL105

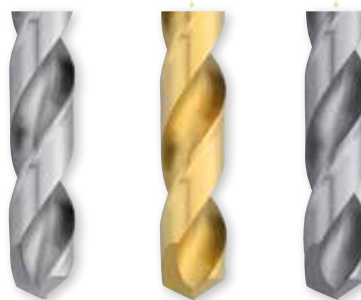

D h8	L	I	CODE	HSS+5%Co 5106..... €	HSS+5%Co 6106..... € QUARTZ	HSS+5%Co 7106..... € TITANITE	HSS+8%Co 5105..... €	HSS+8%Co 6105..... € QUARTZ	HSS+8%Co 7105..... € TITANITE
0,3	19	300030	5,40	7,61	8,89			
0,4	20	500040	4,10	6,19	7,47			
0,5	22	600050	4,10	6,19	7,47			
0,6	24	700060	3,95	6,02	7,30			
0,7	28	900070	3,37	5,40	6,67			
0,75	28	900075	3,37	5,40	6,67			
0,8	30	1000080	3,06	5,04	6,33			
0,9	32	1100090	3,06	5,04	6,33			
1	34	1200100	2,10	3,98	5,26			
1,1	36	1400110	2,10	3,98	5,26			
1,2	38	1600120	2,10	3,98	5,26			
1,25	38	1600125	2,33	4,24	5,53			
1,3	38	1600130	2,33	4,24	5,53			
1,4	40	1800140	2,33	4,24	5,53			
1,5	40	1800150	2,44	4,45	5,79			
1,6	43	2000160	2,63	4,64	5,99			
1,7	43	2000170	2,63	4,64	5,99			
1,75	46	2200175	2,60	4,63	5,97			
1,8	46	2200180	2,63	4,64	5,99			
1,9	46	2200190	2,63	4,64	5,99			
2	49	2400200	2,12	4,09	5,44	3,60	5,62	6,91
2,05	49	2400205				3,84	6,18	7,68
2,1	49	2400210	2,63	4,97	6,53	3,84	6,18	7,68
2,2	53	2700220	2,63	4,97	6,53	3,84	6,18	7,68
2,25	53	2700225	2,63	4,97	6,53	4,00	6,38	7,87
2,3	53	2700230	2,63	4,97	6,53	3,84	6,18	7,68
2,4	57	3000240	2,63	4,97	6,53	3,93	6,29	7,79
2,5	57	3000250	2,28	4,59	6,16	3,84	6,18	7,68
2,6	57	3000260	2,63	4,97	6,53	4,08	6,46	7,96
2,7	61	3300270	2,63	4,97	6,53	4,08	6,46	7,96
2,75	61	3300275	2,63	4,97	6,53	4,31	6,72	8,21
2,8	61	3300280	2,63	4,97	6,53	4,16	6,55	8,03
2,9	61	3300290	2,63	4,97	6,53	4,16	6,55	8,03
3	61	3300300	2,28	4,59	6,16	3,44	5,77	7,25
3,1	65	3600310	2,89	5,16	6,66	4,16	6,55	8,03
3,2	65	3600320	2,89	5,16	6,66	4,16	6,55	8,03
3,25	65	3600325	2,89	5,16	6,66	4,31	6,72	8,21
3,3	65	3600330	2,89	5,16	6,66	4,41	6,82	8,30
3,4	70	3900340	2,89	5,16	6,66	4,56	6,99	8,49
3,5	70	3900350	2,57	4,81	6,32	4,23	6,63	8,12

D h8	L	I	CODE	HSS+5%Co	HSS+5%Co	HSS+5%Co	HSS+8%Co	HSS+8%Co	HSS+8%Co
				5106..... €	6106..... € QUARTZ	7106..... € TITANITE	5105..... €	6105..... € QUARTZ	7105..... € TITANITE
3,6	70	3900360	3,21	5,53	7,02	4,56	6,99	8,49
3,7	70	3900370	3,21	5,53	7,02	4,64	7,08	8,57
3,75	70	3900375	3,21	5,53	7,02	5,12	7,60	9,09
3,8	75	4300380	3,29	5,60	7,10	4,72	7,16	8,66
3,9	75	4300390	3,29	5,60	7,10	4,88	7,34	8,84
4	75	4300400	2,89	5,87	7,94	4,56	6,99	8,49
4,1	75	4300410	3,54	6,58	8,66	4,96	8,13	10,20
4,2	75	4300420	3,54	6,58	8,66	4,96	8,13	10,20
4,25	75	4300425	3,71	7,67	10,42	4,88	8,04	10,11
4,3	80	4700430	3,69	7,49	10,11	5,28	9,20	11,81
4,4	80	4700440	3,69	7,49	10,11	5,37	9,31	11,92
4,5	80	4700450	3,21	6,96	9,59	5,04	8,94	11,55
4,6	80	4700460	3,86	7,65	10,28	5,52	9,47	12,09
4,7	80	4700470	3,86	7,65	10,28	5,67	9,64	12,25
4,75	80	4700475	3,78	7,50	10,08	5,52	9,42	12,00
4,8	86	5200480	3,86	7,65	10,28	5,67	9,64	12,25
4,9	86	5200490	3,86	7,65	10,28	5,85	9,83	12,43
5	86	5200500	3,46	7,23	9,86	5,44	9,38	12,00
5,1	86	5200510	5,12	8,97	11,56	5,84	9,77	12,34
5,2	86	5200520	5,12	8,97	11,56	5,91	9,86	12,43
5,25	86	5200525	5,12	8,97	11,56	5,91	9,86	12,43
5,3	86	5200530	5,12	8,97	11,56	5,91	9,86	12,43
5,4	93	5700540	5,12	8,97	11,56	6,93	10,97	13,55
5,5	93	5700550	4,65	8,46	11,04	6,85	10,90	13,47
5,6	93	5700560	5,12	8,97	11,56	7,48	11,57	14,15
5,7	93	5700570	5,12	8,97	11,56	7,48	11,57	14,15
5,75	93	5700575	5,67	9,75	12,44	7,48	11,57	14,15
5,8	93	5700580	5,44	9,33	11,91	7,48	11,57	14,15
5,9	93	5700590	5,44	9,33	11,91	7,48	11,57	14,15
6	93	5700600	4,65	10,01	13,81	7,08	11,14	13,71
6,1	101	6300610	6,24	11,77	15,56	7,72	13,40	17,21
6,2	101	6300620	6,24	11,77	15,56	8,42	14,17	17,98
6,25	101	6300625	6,54	12,34	16,31	8,42	14,17	17,98
6,3	101	6300630	6,45	12,01	15,81	8,42	14,17	17,98
6,4	101	6300640	6,45	12,01	15,81	9,14	14,97	18,76
6,5	101	6300650	5,59	11,06	14,85	8,35	14,08	17,89
6,6	101	6300660	7,48	13,14	16,94	9,14	14,97	18,76
6,7	101	6300670	7,48	13,14	16,94	9,14	14,97	18,76
6,75	109	6900675	7,48	13,14	16,94	9,77	15,65	19,45
6,8	109	6900680	7,48	13,14	16,94	9,77	15,65	19,45
6,9	109	6900690	7,48	13,14	16,94	9,77	15,65	19,45
7	109	6900700	6,68	12,27	16,07	8,82	14,61	18,41
7,1	109	6900710	7,95	13,65	17,45	11,88	17,98	21,78
7,2	109	6900720	7,95	13,65	17,45	11,88	17,98	21,78
7,25	109	6900725	7,72	13,40	17,21	11,88	17,98	21,78
7,3	109	6900730	8,10	13,83	17,62	11,88	17,98	21,78
7,4	109	6900740	8,10	13,83	17,62	11,88	17,98	21,78
7,5	109	6900750	6,85	12,44	16,25	9,29	15,13	18,92
7,6	117	7500760	9,05	14,86	18,67	14,40	20,75	24,56
7,7	117	7500770	9,05	14,86	18,67	14,40	20,75	24,56
7,75	117	7500775	9,58	15,49	19,48	14,40	20,75	24,56
7,8	117	7500780	9,05	14,86	18,67	14,40	20,75	24,56
7,9	117	7500790	9,05	14,86	18,67	14,40	20,75	24,56
8	117	7500800	8,03	14,90	19,60	10,93	16,94	20,74
8,1	117	7500810	9,77	16,81	21,51	14,40	21,92	26,62
8,2	117	7500820	9,77	16,81	21,51	14,40	21,92	26,62
8,25	117	7500825	9,45	16,46	21,16	13,76	21,23	25,91
8,3	117	7500830	9,91	16,98	21,68	14,40	21,92	26,62
8,4	117	7500840	9,91	16,98	21,68	14,40	21,92	26,62
8,5	117	7500850	8,50	15,43	20,13	11,33	18,54	23,24

CL 106



CL 105

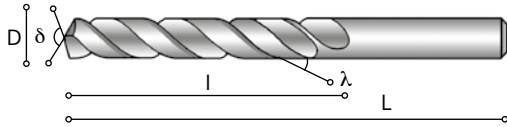

Dal $\varnothing 0,3$ al $\varnothing 6 = 10$ pz
Dal $\varnothing 6,1$ al $\varnothing 13 = 5$ pz
Dal $\varnothing 13,25$ al $\varnothing 20 = 1$ pz

CL106

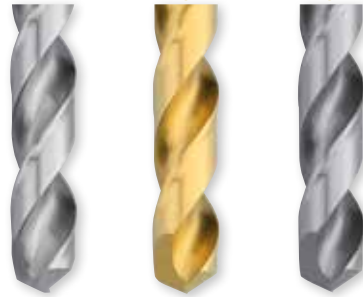

CL105

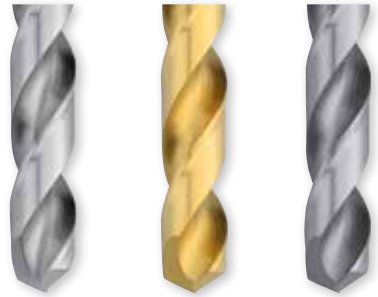

D h8	L	I	CODE	HSS+5%Co	HSS+5%Co	HSS+5%Co	HSS+8%Co	HSS+8%Co	HSS+8%Co
				5106..... €	6106..... € QUARTZ	7106..... € TITANITE	5105..... €	6105..... € QUARTZ	7105..... € TITANITE
8,6	125	8100860	11,73	18,97	23,67	16,93	24,68	29,38
8,7	125	8100870	11,73	18,97	23,67	16,93	24,68	29,38
8,75	125	8100875	11,65	18,90	23,60	17,48	25,29	29,98
8,8	125	8100880	11,73	18,97	23,67	17,48	25,29	29,98
8,9	125	8100890	11,73	18,97	23,67	17,48	25,29	29,98
9	125	8100900	10,38	17,50	22,20	14,56	22,10	26,80
9,1	125	8100910	12,99	20,37	25,07	18,81	26,77	31,47
9,2	125	8100920	12,99	20,37	25,07	18,81	26,77	31,47
9,25	125	8100925	12,60	19,93	24,63	19,43	27,45	32,15
9,3	125	8100930	13,23	20,61	25,31	20,63	28,76	33,45
9,4	125	8100940	13,97	21,43	26,13	20,63	28,76	33,45
9,5	125	8100950	11,50	18,73	23,43	14,95	22,53	27,23
9,6	133	8700960	14,24	21,74	26,44	23,13	31,52	36,22
9,7	133	8700970	14,24	21,74	26,44	23,69	32,12	36,82
9,75	133	8700975	14,08	21,57	26,27	22,81	31,18	35,87
9,8	133	8700980	14,24	21,74	26,44	23,76	32,21	36,91
9,9	133	8700990	14,24	21,74	26,44	23,76	32,21	36,91
10	133	8701000	12,60	19,93	24,63	16,61	24,34	29,04
10,1	133	8701010	18,41	26,34	31,03			
10,2	133	8701020	18,41	26,34	31,03	31,47	40,69	45,39
10,25	133	8701025	20,46	28,58	33,27	31,47	40,69	45,39
10,3	133	8701030	18,41	26,34	31,03			
10,4	133	8701040	18,41	26,34	31,03			
10,5	133	8701050	15,90	23,57	28,27	24,71	33,26	37,96
10,6	133	8701060	22,68	32,91	39,09			
10,7	142	9401070	22,68	32,91	39,09			
10,75	142	9401075	23,21	32,87	38,55	29,74	40,05	45,73
10,8	142	9401080	23,09	33,09	39,05			
10,9	142	9401090	23,09	33,09	39,05			
11	142	9401100	18,49	27,67	33,35	29,74	40,05	45,73
11,1	142	9401110	23,02	32,66	38,34			
11,2	142	9401120	23,02	32,66	38,34			
11,25	142	9401125	25,59	35,49	41,17	35,01	45,85	51,54
11,3	142	9401130	23,02	32,66	38,34			
11,4	142	9401140	23,02	32,66	38,34			
11,5	142	9401150	19,36	28,63	34,31	35,01	45,85	51,54
11,6	142	9401160	25,68	35,58	41,26			
11,7	142	9401170	25,68	35,58	41,26			
11,75	142	9401175	28,51	38,69	44,37	37,29	48,36	54,04
11,8	142	9401180	25,68	35,58	41,26			

D h8	L	I	CODE	HSS+5%Co	HSS+5%Co	HSS+5%Co	HSS+8%Co	HSS+8%Co	HSS+8%Co
				5106..... €	6106..... € QUARTZ	7106..... € TITANITE	5105..... €	6105..... € QUARTZ	7105..... € TITANITE
11,9	151	10101190	25,68	35,58	41,26			
12	151	10101200	21,57	32,05	38,45	37,29	48,36	54,04
12,1	151	10101210	27,92	39,04	45,45			
12,2	151	10101220	27,92	39,04	45,45			
12,25	151	10101225	31,00	42,42	48,83	46,81	59,81	66,22
12,3	151	10101230	27,92	39,04	45,45			
12,4	151	10101240	27,92	39,04	45,45			
12,5	151	10101250	23,45	34,12	40,52	46,81	59,81	66,22
12,6	151	10101260	31,73	44,20	49,13			
12,7	151	10101270	26,91	37,92	44,32			
12,75	151	10101275	31,58	43,06	49,46	50,59	63,97	70,37
12,8	151	10101280	31,73	44,20	51,36			
12,9	151	10101290	31,73	44,20	51,36			
13	151	10101300	25,27	36,12	42,53	50,59	63,97	70,37
13,25	160	10801325				55,57	69,62	76,14
13,5	160	10801350				54,51	68,29	74,69
13,75	160	10801375				54,63	68,57	75,10
14	160	10801400				53,59	67,27	73,67
14,25	169	11401425				78,03	94,32	100,85
14,5	169	11401450				76,55	92,53	98,93
14,75	169	11401475				75,87	91,93	98,46
15	169	11401500				74,42	90,18	96,59
15,25	178	12001525				87,75	105,00	111,54
15,5	178	12001550				86,07	103,00	109,41
15,75	178	12001575				91,02	108,60	115,13
16	178	12001600				91,08	108,66	115,19
16,25	184	12501625				101,77	127,99	140,40
16,5	184	12501650				99,83	125,55	137,73
16,75	184	12501675				106,10	132,76	145,18
17	184	12501700				104,08	130,23	142,41
17,25	191	13001725				114,86	142,40	154,82
17,5	191	13001750				112,67	139,69	151,86
17,75	191	13001775				128,00	156,87	169,28
18	191	13001800				125,56	153,88	166,06
18,25	198	13501825				133,57	171,94	191,27
18,5	198	13501850				131,02	168,67	187,63
18,75	198	13501875				141,35	180,51	199,84
19	198	13501900				138,66	177,06	196,02
19,25	205	14001925				145,20	184,74	204,05
19,5	205	14001950				142,43	181,22	200,16
19,75	205	14001975				181,10	224,23	243,56
20	205	14002000				177,65	219,95	238,91

CL 109

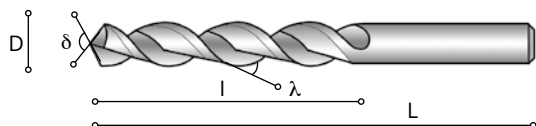
FORI PROFONDI
DEEP HOLE

CL109

Dal $\varnothing 2$ al $\varnothing 6$ = 10 pz
Dal $\varnothing 6,1$ al $\varnothing 13$ = 5 pz

D h8	L	l	CODE	HSS+5%Co 5109..... €	HSS+5%Co 6109..... € QUARTZ	HSS+5%Co 7109..... € TITANITE
2	49	24	...00200	3,29	5,30	6,58
2,1	49	24	...00210	3,29	5,60	7,10
2,2	53	27	...00220	3,29	5,60	7,10
2,3	53	27	...00230	3,29	5,60	7,10
2,4	57	30	...00240	3,62	5,97	7,46
2,5	57	30	...00250	3,29	5,60	7,10
2,6	57	30	...00260	3,62	5,97	7,46
2,7	61	33	...00270	3,69	6,05	7,55
2,8	61	33	...00280	3,69	6,05	7,55
2,9	61	33	...00290	3,69	6,05	7,55
3	61	33	...00300	3,62	5,97	7,46
3,1	65	36	...00310	3,86	6,21	7,72
3,2	65	36	...00320	3,86	6,21	7,72
3,3	65	36	...00330	3,86	6,21	7,72
3,4	70	39	...00340	4,10	6,49	8,00
3,5	70	39	...00350	4,10	6,49	8,00
3,6	70	39	...00360	4,34	6,75	8,25
3,7	70	39	...00370	4,34	6,75	8,25
3,8	75	43	...00380	4,34	6,75	8,25
3,9	75	43	...00390	4,34	6,75	8,25
4	75	43	...00400	4,34	6,75	8,25
4,1	75	43	...00410	4,51	7,64	9,72
4,2	75	43	...00420	4,51	7,64	9,72
4,3	80	47	...00430	5,47	9,42	12,06
4,4	80	47	...00440	5,47	9,42	12,06
4,5	80	47	...00450	5,47	9,42	12,06
4,6	80	47	...00460	5,47	9,42	12,06
4,7	80	47	...00470	5,47	9,42	12,06
4,8	86	52	...00480	5,47	9,42	12,06
4,9	86	52	...00490	5,47	9,42	12,06
5	86	52	...00500	5,47	9,42	12,06
5,1	86	52	...00510	5,96	9,97	12,59
5,2	86	52	...00520	5,96	9,97	12,59
5,3	86	52	...00530	5,96	9,97	12,59
5,4	93	57	...00540	7,55	11,73	14,35
5,5	93	57	...00550	7,14	11,28	13,91
5,6	93	57	...00560	7,63	11,80	14,43
5,7	93	57	...00570	7,63	11,80	14,43
5,8	93	57	...00580	7,63	11,80	14,43
5,9	93	57	...00590	7,63	11,80	14,43

D h8	L	I	CODE	HSS+5%Co 5109..... €	HSS+5%Co 6109..... € QUARTZ	HSS+5%Co 7109..... € TITANITE
6	93	5700600	7,22	11,36	13,98
6,1	101	6300610	8,19	14,01	17,89
6,2	101	6300620	8,19	14,01	17,89
6,5	101	6300650	8,52	14,36	18,25
6,8	109	6900680	9,00	14,90	18,78
7	109	6900700	8,75	14,63	18,50
7,2	109	6900720	12,85	19,15	23,01
7,5	109	6900750	10,43	16,49	20,37
7,8	117	7500780	14,36	20,82	24,69
8	117	7500800	10,91	17,01	20,89
8,2	117	7500820	15,18	22,89	27,68
8,5	117	7500850	11,80	19,19	23,98
8,8	125	8100880	17,75	25,71	30,51
9	125	8100900	13,45	21,00	25,80
9,2	125	8100920	19,98	28,17	32,96
9,5	125	8100950	15,22	22,93	27,72
9,8	133	8700980	22,14	30,57	35,36
10	133	8701000	16,30	24,12	28,92
10,5	133	8701050	23,35	31,88	36,67
11	142	9401100	24,89	34,85	38,36
11,5	142	9401150	28,83	39,18	42,69
12	151	10101200	29,87	40,33	46,12
12,5	151	10101250	34,58	46,53	53,06
13	151	10101300	34,90	46,88	53,43

CL 119

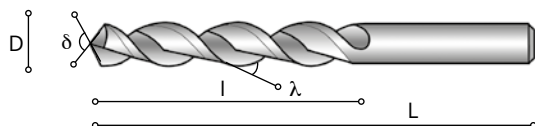
ACCIAIO INOX
STAINLESS STEELDal $\varnothing 1$ al $\varnothing 6 = 10$ pz
Dal $\varnothing 6,1$ al $\varnothing 13 = 5$ pz
Dal $\varnothing 13,25$ al $\varnothing 31 = 1$ pz

CL119



D h8	L	I	CODE	HSS+5%Co 5119..... €	HSS+5%Co 6119..... € QUARTZ	HSS+5%Co 7119..... € TITANITE
2	49	24	...00200	2,82	5,42	7,21
2,1	49	24	...00210	3,24	6,13	8,05
2,2	53	27	...00220	3,24	6,13	8,05
2,25	53	27	...00225	3,43	6,28	8,26
2,3	53	27	...00230	3,24	6,13	8,05
2,4	57	30	...00240	3,28	6,21	8,16
2,5	57	30	...00250	3,01	6,04	8,11
2,6	57	30	...00260	3,37	6,36	8,36
2,7	61	33	...00270	3,37	6,36	8,36
2,75	61	33	...00275	3,85	7,27	9,56
2,8	61	33	...00280	3,41	6,44	8,46
2,9	61	33	...00290	3,41	6,44	8,46
3	61	33	...00300	2,82	5,65	7,59
3,1	65	36	...00310	3,53	6,31	8,15
3,2	65	36	...00320	3,53	6,31	8,15
3,25	65	36	...00325	3,61	6,46	8,33
3,3	65	36	...00330	3,65	6,54	8,44
3,4	70	39	...00340	3,73	6,67	8,62
3,5	70	39	...00350	3,35	6,27	8,23
3,6	70	39	...00360	3,90	6,70	8,51
3,7	70	39	...00370	3,94	6,77	8,60
3,75	70	39	...00375	4,18	7,18	9,12
3,8	75	43	...00380	4,02	6,83	8,67
3,9	75	43	...00390	4,10	6,98	8,85
4	75	43	...00400	3,66	7,44	10,07
4,1	75	43	...00410	4,26	7,93	10,43
4,2	75	43	...00420	4,26	7,93	10,43
4,25	75	43	...00425	4,31	8,90	12,11
4,3	80	47	...00430	4,50	9,11	12,30
4,4	80	47	...00440	4,55	9,20	12,43
4,5	80	47	...00450	4,06	8,79	12,11
4,6	80	47	...00460	4,70	9,34	12,55
4,7	80	47	...00470	4,78	9,50	12,75
4,75	80	47	...00475	4,74	9,41	12,65
4,8	86	52	...00480	4,78	9,50	12,75
4,9	86	52	...00490	4,87	9,66	12,97
5	86	52	...00500	4,38	9,15	12,47
5,1	86	52	...00510	5,59	9,79	12,62
5,2	86	52	...00520	5,63	9,86	12,71
5,25	86	52	...00525	5,52	9,67	12,46
5,3	86	52	...00530	5,63	9,86	12,71

D h8	L	I	CODE	HSS+5%Co 5119..... €	HSS+5%Co 6119..... € QUARTZ	HSS+5%Co 7119..... € TITANITE
5,4	93	5700540	6,14	10,77	13,87
5,5	93	5700550	5,75	10,47	13,65
5,6	93	5700560	6,43	11,26	14,50
5,7	93	5700570	6,43	11,26	14,50
5,75	93	5700575	6,70	11,53	14,72
5,8	93	5700580	6,59	11,30	14,41
5,9	93	5700590	6,59	11,30	14,41
6	93	5700600	5,86	12,63	17,43
6,1	101	6300610	6,98	13,17	17,41
6,2	101	6300620	7,33	13,83	18,29
6,25	101	6300625	7,48	14,12	18,66
6,3	101	6300630	7,44	13,84	18,23
6,4	101	6300640	7,80	14,51	19,11
6,5	101	6300650	6,97	13,78	18,50
6,6	101	6300660	8,31	14,60	18,82
6,7	101	6300670	8,31	14,60	18,82
6,75	109	6900675	8,62	15,15	19,53
6,8	109	6900680	8,62	15,15	19,53
6,9	109	6900690	8,62	15,15	19,53
7	109	6900700	7,75	14,23	18,64
7,1	109	6900710	9,92	17,02	21,76
7,2	109	6900720	9,92	17,02	21,76
7,25	109	6900725	9,80	17,02	21,84
7,3	109	6900730	9,99	17,05	21,72
7,4	109	6900740	9,99	17,05	21,72
7,5	109	6900750	8,07	14,67	19,15
7,6	117	7500760	11,73	19,26	24,18
7,7	117	7500770	11,73	19,26	24,18
7,75	117	7500775	11,99	19,39	24,38
7,8	117	7500780	11,73	19,26	24,18
7,9	117	7500790	11,73	19,26	24,18
8	117	7500800	9,48	17,60	23,15
8,1	117	7500810	12,09	20,80	26,61
8,2	117	7500820	12,09	20,80	26,61
8,25	117	7500825	11,61	20,22	26,00
8,3	117	7500830	12,16	20,83	26,59
8,4	117	7500840	12,16	20,83	26,59
8,5	117	7500850	9,92	17,99	23,48
8,6	125	8100860	14,33	23,18	28,92
8,7	125	8100870	14,33	23,18	28,92
8,75	125	8100875	14,56	23,62	29,49
8,8	125	8100880	14,60	23,62	29,47
8,9	125	8100890	14,60	23,62	29,47
9	125	8100900	12,47	21,02	26,66
9,1	125	8100910	15,90	24,92	30,67
9,2	125	8100920	15,90	24,92	30,67
9,25	125	8100925	16,34	25,85	31,95
9,3	125	8100930	16,93	26,38	32,39
9,4	125	8100940	17,30	26,54	32,36
9,5	125	8100950	13,23	21,55	26,95
9,6	133	8700960	18,69	28,53	34,70
9,7	133	8700970	18,96	28,95	35,21
9,75	133	8700975	18,45	28,26	34,42
9,8	133	8700980	19,00	29,01	35,28
9,9	133	8700990	19,00	29,01	35,28
10	133	8701000	14,60	23,10	28,55
10,1	133	8701010	23,93	34,24	40,34
10,2	133	8701020	24,94	35,68	42,04
10,25	133	8701025	25,96	36,27	42,23
10,3	133	8701030	23,93	34,24	40,34

CL 119

ACCIAIO INOX
STAINLESS STEEL



DIN 1412 B

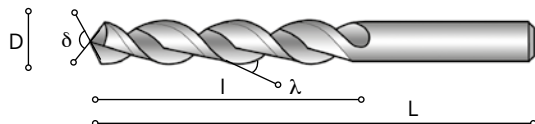

Dal \varnothing 1 al \varnothing 6 = 10 pz
Dal \varnothing 6,1 al \varnothing 13 = 5 pz
Dal \varnothing 13,25 al \varnothing 31 = 1 pz

CL119



D h8	L	I	CODE	HSS+5%Co 5119..... €	HSS+5%Co 6119..... € QUARTZ	HSS+5%Co 7119..... € TITANITE
10,4	133	8701040	23,93	34,24	40,34
10,5	133	8701050	20,31	30,10	36,10
10,6	133	8701060	29,48	42,78	50,82
10,7	142	9401070	29,48	42,78	50,82
10,75	142	9401075	27,01	38,24	44,85
10,8	142	9401080	30,02	43,02	50,77
10,9	142	9401090	30,02	43,02	50,77
11	142	9401100	24,11	36,09	43,50
11,1	142	9401110	29,93	42,46	49,85
11,2	142	9401120	29,93	42,46	49,85
11,25	142	9401125	30,30	42,02	48,75
11,3	142	9401130	29,93	42,46	49,85
11,4	142	9401140	29,93	42,46	49,85
11,5	142	9401150	27,19	40,21	48,19
11,6	142	9401160	33,39	46,25	53,64
11,7	142	9401170	33,39	46,25	53,64
11,75	142	9401175	32,90	44,65	51,21
11,8	142	9401180	33,39	46,25	53,64
11,9	151	10101190	33,39	46,25	53,64
12	151	10101200	29,43	43,72	52,46
12,1	151	10101210	36,30	50,75	59,09
12,2	151	10101220	36,30	50,75	59,09
12,25	151	10101225	38,90	53,23	61,28
12,3	151	10101230	36,30	50,75	59,09
12,4	151	10101240	36,30	50,75	59,09
12,5	151	10101250	35,13	51,11	60,69
12,6	151	10101260	41,25	57,46	63,87
12,7	151	10101270	34,99	49,30	57,62
12,75	151	10101275	41,70	56,01	65,29
12,8	151	10101280	41,87	57,46	67,77
12,9	151	10101290	41,87	57,46	67,77
13	151	10101300	38,50	54,20	64,79
13,5	160	10801350	41,50	51,22	56,86
14	160	10801400	40,79	50,45	56,08
14,5	169	11401450	53,81	64,08	69,54
15	169	11401500	54,43	64,98	70,63
15,5	178	12001550	61,84	72,91	78,61
16	178	12001600	64,63	75,97	81,74

CL 200



STANDARD



CL 230

FORI PROFONDI
DEEP HOLE



DIN 1412 C

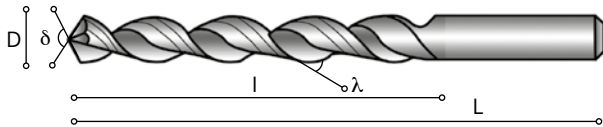

CL200



CL230



Dal Ø 0,5 al Ø 6 = 10 pz
Dal Ø 6,1 al Ø 13 = 5 pz

D h8	L	l	CODE	HSS 5200..... €	HSS+5%Co 5230..... €	HSS+5%Co 6230..... € QUARTZ	HSS+5%Co 7230..... € TITANITE
0,5	32	1200050	11,97			
0,6	35	1500060	9,69			
0,7	42	2100070	8,50			
0,8	46	2500080	7,95			
0,9	51	2900090	7,55			
1	56	3300100	4,81			
1,1	60	3700110	4,97			
1,2	65	4100120	4,25			
1,25	65	4100125	3,55			
1,3	65	4100130	4,25			
1,4	70	4500140	4,42			
1,5	70	4500150	3,62			
1,6	76	5000160	4,02			
1,7	76	5000170	3,95			
1,75	80	5300175	4,44			
1,8	80	5300180	3,95			
1,9	80	5300190	3,95			
2	85	5600200	2,89	5,91	8,63	10,27
2,1	85	5600210	3,06	6,03	9,17	11,15
2,2	90	5900220	3,06	6,36	9,52	11,51
2,25	90	5900225	3,77	7,12	10,32	12,27
2,3	90	5900230	3,06	6,36	9,52	11,51
2,4	95	6200240	3,06	6,36	9,52	11,51
2,5	95	6200250	3,06	6,24	9,33	11,28
2,6	95	6200260	3,29	6,36	9,52	11,51
2,7	100	6600270	3,29	6,36	9,52	11,51
2,75	100	6600275	4,18	7,26	10,53	12,52
2,8	100	6600280	3,54	6,36	9,52	11,51
2,9	100	6600290	3,86	6,36	9,52	11,51
3	100	6600300	2,89	6,24	9,33	11,28
3,1	106	6900310	3,46	7,78	11,92	14,48
3,2	106	6900320	3,46	7,47	11,59	14,15
3,25	106	6900325	4,44	8,59	12,80	15,37
3,3	106	6900330	3,69	7,47	11,59	14,15
3,4	112	7300340	3,69	7,96	12,11	14,67
3,5	112	7300350	3,46	6,61	10,56	13,07
3,6	112	7300360	3,69	8,35	12,55	15,13
3,7	112	7300370	3,86	8,35	12,55	15,13
3,75	112	7300375	4,74	9,15	13,42	15,98
3,8	119	7800380	3,95	9,00	13,25	15,81

CL 200

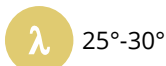

STANDARD



CL 230

FORI PROFONDI
DEEP HOLE



DIN 1412 C

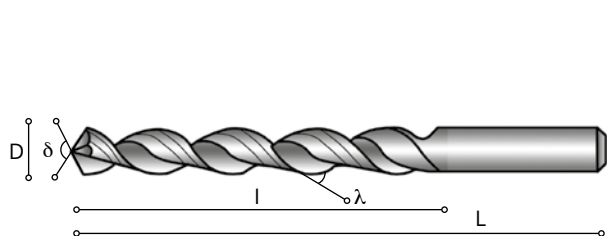

CL200



CL230



Dal \varnothing 0,5 al \varnothing 6 = 10 pz
Dal \varnothing 6,1 al \varnothing 13 = 5 pz

D h8	L	I	CODE	HSS 5200..... €	HSS+5%Co 5230..... €	HSS+5%Co 6230..... € QUARTZ	HSS+5%Co 7230..... € TITANITE
3,9	119	7800390	4,10	9,00	13,25	15,81
4	119	7800400	3,70	7,32	11,36	13,87
4,1	119	7800410	4,34	8,44	13,33	16,48
4,2	119	7800420	4,34	8,44	13,33	16,48
4,25	119	7800425	5,43	11,80	16,96	20,05
4,3	126	8200430	4,91	11,40	16,60	19,75
4,4	126	8200440	4,91	11,40	16,60	19,75
4,5	126	8200450	4,49	8,74	13,60	16,68
4,6	126	8200460	4,91	11,40	16,60	19,75
4,7	126	8200470	4,91	11,40	16,60	19,75
4,75	126	8200475	6,27	12,91	18,17	21,25
4,8	132	8700480	5,30	11,96	17,23	20,36
4,9	132	8700490	5,30	11,96	17,23	20,36
5	132	8700500	4,89	9,14	14,03	17,12
5,1	132	8700510	5,70	11,73	16,89	19,96
5,2	132	8700520	5,70	11,73	16,89	19,96
5,25	132	8700525	7,23	12,91	18,17	21,25
5,3	132	8700530	5,70	11,73	16,89	19,96
5,4	139	9100540	6,51	13,30	18,60	21,69
5,5	139	9100550	5,99	10,63	15,67	18,76
5,6	139	9100560	6,51	14,40	19,83	22,92
5,7	139	9100570	6,51	14,40	19,83	22,92
5,75	139	9100575	7,53	15,82	21,39	24,47
5,8	139	9100580	6,51	14,40	19,83	22,92
5,9	139	9100590	6,51	14,40	19,83	22,92
6	139	9100600	5,99	12,05	17,23	20,32
6,1	148	9700610	7,63			
6,2	148	9700620	7,63	18,41	26,68	31,65
6,25	148	9700625	8,25	20,31	28,77	33,74
6,3	148	9700630	7,63			
6,4	148	9700640	8,11			
6,5	148	9700650	7,48	18,41	26,69	31,65
6,6	148	9700660	8,11			
6,7	148	9700670	8,11			
6,75	156	10200675	8,74	20,31	28,77	33,74
6,8	156	10200680	9,40	20,78	29,29	34,27
6,9	156	10200690	9,40			
7	156	10200700	8,82	17,55	25,73	30,70
7,1	156	10200710	11,73			
7,2	156	10200720	11,73	22,74	31,45	36,41

D h8	L	I	CODE	HSS 5200..... €	HSS+5%Co 5230..... €	HSS+5%Co 6230..... € QUARTZ	HSS+5%Co 7230..... € TITANITE
7,25	156	10200725	10,49	25,03	33,97	38,93
7,3	156	10200730	11,73			
7,4	156	10200740	11,73			
7,5	156	10200750	9,29	19,83	28,25	33,21
7,6	165	10900760	12,20			
7,7	165	10900770	12,44			
7,75	165	10900775	11,51	26,84	35,95	40,92
7,8	165	10900780	12,28	24,31	33,18	38,14
7,9	165	10900790	12,20			
8	165	10900800	10,63	20,31	28,77	33,74
8,1	165	10900810	13,41			
8,2	165	10900820	13,41	24,48	34,27	39,94
8,25	165	10900825	11,88	26,99	37,02	42,71
8,3	165	10900830	13,41			
8,4	165	10900840	13,15			
8,5	165	10900850	11,80	22,74	32,34	38,03
8,6	175	11500860	16,45			
8,7	175	11500870	16,45			
8,75	175	11500875	14,22	27,60	37,70	43,37
8,8	175	11500880	16,45	25,10	34,95	40,63
8,9	175	11500890	16,45			
9	175	11500900	12,60	23,84	33,56	39,24
9,1	175	11500910	17,60			
9,2	175	11500920	17,60	32,19	42,74	48,42
9,25	175	11500925	15,66	35,49	46,38	52,05
9,3	175	11500930	17,60			
9,4	175	11500940	17,60			
9,5	175	11500950	14,48	31,09	41,53	47,21
9,6	184	12100960	17,77			
9,7	184	12100970	17,44			
9,75	184	12100975	16,78	47,60	62,59	70,49
9,8	184	12100980	17,67	43,27	57,83	65,75
9,9	184	12100990	17,67			
10	184	12101000	14,56	32,74	46,24	54,14
10,1	184	12101010	19,19			
10,2	184	12101020	19,19			
10,25	184	12101025	19,11	55,39	71,16	79,06
10,3	184	12101030	19,19			
10,4	184	12101040	19,19			
10,5	184	12101050	19,11	50,36	65,63	73,52
10,6	184	12101060	18,81			
10,7	195	12801070	21,94			
10,75	195	12801075	22,42	63,26	79,83	87,73
10,8	195	12801080	22,38			
10,9	195	12801090	22,38			
11	195	12801100	21,01	47,28	62,25	70,15
11,1	195	12801110	21,04			
11,2	195	12801120	24,75			
11,25	195	12801125	24,77	69,62	86,81	94,72
11,3	195	12801130	24,26			
11,4	195	12801140	24,26			
11,5	195	12801150	21,47	63,26	79,83	87,73
11,6	195	12801160	23,48			
11,7	195	12801170	26,66			
11,75	195	12801175	27,17	75,28	93,04	100,95
11,8	195	12801180	25,12			
11,9	205	13401190	25,12			
12	205	13401200	23,84	64,35	81,02	88,91
12,1	205	13401210	26,88			
12,2	205	13401220	26,88			

CL 200



STANDARD



CL 230

FORI PROFONDI
DEEP HOLE



DIN 1412 C

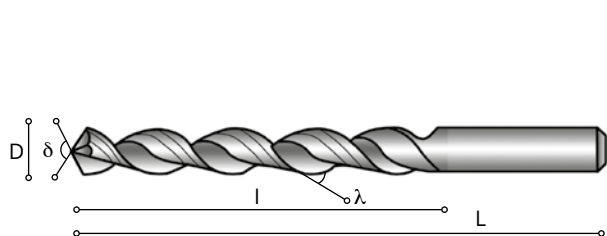

CL200



CL230



Dal \varnothing 0,5 al \varnothing 6 = 10 pz
Dal \varnothing 6,1 al \varnothing 13 = 5 pz

D h8	L	I	CODE	HSS 5200..... €	HSS+5%Co 5230..... €	HSS+5%Co 6230..... € QUARTZ	HSS+5%Co 7230..... € TITANITE
12,25	205	13401225	28,61	76,15	95,83	105,14
12,3	205	13401230	26,48			
12,4	205	13401240	26,48			
12,5	205	13401250	24,88	69,22	88,21	97,52
12,6	205	13401260	24,89			
12,7	205	13401270	40,62			
12,75	205	13401275	39,82	82,38	102,66	111,97
12,8	205	13401280	40,62			
12,9	205	13401290	43,95			
13	205	13401300	26,91	64,90	83,45	92,75
13,25	214	14001325	51,66			
13,5	214	14001350	32,50			
13,75	214	14001375	56,69			
14	214	14001400	31,94			
14,25	220	14401425	68,99			
14,5	220	14401450	39,81			
14,75	220	14401475	71,30			
15	220	14401500	37,37			
15,25	227	14901525	71,30			
15,5	227	14901550	54,38			
15,75	227	14901575	73,46			
16	227	14901600	45,76			
16,25	235	15401625	75,79			
16,5	235	15401650	71,22			
16,75	235	15401675	75,79			
17	235	15401700	56,91			
17,25	241	15801725	76,41			
17,5	241	15801750	71,78			
17,75	241	15801775	76,41			
18	241	15801800	64,12			
18,25	247	16201825	121,28			
18,5	247	16201850	113,94			
18,75	247	16201875	121,28			
19	247	16201900	78,45			
19,25	254	16601925	128,06			
19,5	254	16601950	120,25			
19,75	254	16601975	120,25			
20	254	16602000	93,45			

CL 111-1



25°-30°



STANDARD



CL 110-1

FORI PROFONDI
DEEP HOLE



35°-40°



DIN 1412 C

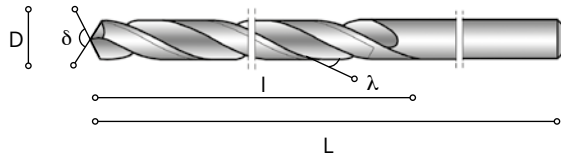

CL111-1



CL110-1



Dal Ø 3 al Ø 8 = 5 pz
Dal Ø 8,25 al Ø 13 = 1 pz

D h8	L	I	CODE	HSS 5111..... €	HSS+5%Co 5110..... €	HSS+5%Co 6110..... € QUARTZ	HSS+5%Co 7110..... € TITANITE
2	125	8500200	8,91	12,29	16,02	18,40
2,25	135	9000225	10,55	15,26	19,69	21,56
2,5	140	9500250	8,59	12,29	16,48	18,40
2,75	150	10000275	10,55	16,85	22,75	24,04
3	150	10000300	9,22	13,70	19,28	20,59
3,25	155	10500325	11,33	16,85	22,75	24,04
3,5	165	11500350	10,55	14,12	19,84	23,39
3,75	165	11500375	13,69	19,43	25,59	29,09
4	175	12000400	10,19	14,12	19,84	23,39
4,25	175	12000425	14,01	20,63	27,95	32,03
4,5	185	12500450	11,10	16,21	25,25	29,55
4,75	185	12500475	14,01	21,25	30,79	35,09
5	195	13500500	11,18	16,21	25,25	29,55
5,25	195	13500525	15,58	21,47	31,03	35,35
5,5	205	14000550	13,32	17,91	27,35	31,78
5,75	205	14000575	17,72	21,47	31,03	35,35
6	205	14000600	14,16	16,70	25,94	30,32
6,25	215	15000625	19,59	25,18	37,58	43,12
6,5	215	15000650	18,63	21,47	33,49	39,04
6,75	225	15500675	21,33	27,39	40,00	45,54
7	225	15500700	18,07	24,00	36,48	42,13
7,25	225	15500725	25,03	34,85	48,22	53,76
7,5	225	15500750	21,79	29,42	42,25	47,79
7,75	240	16500775	25,03	35,96	50,67	56,93
8	240	16500800	24,16	30,05	44,17	50,43
8,25	240	16500825	35,41	47,05	62,88	69,14
8,5	240	16500850	33,39	40,75	55,95	62,21
8,75	250	17500875	35,41	50,35	66,50	72,76
9	250	17500900	31,24	43,43	58,89	65,15
9,25	250	17500925	38,40	58,93	75,93	82,19
9,5	250	17500950	36,73	50,35	66,50	72,76
9,75	265	18500975	40,51	60,02	80,47	88,60
10	265	18501000	34,15	45,63	64,64	72,77
10,5	265	18501050	40,91	60,19	82,23	91,23
11	280	19501100	45,95	58,98	81,22	90,40
11,5	280	19501150	50,19	71,82	95,04	104,04
12	295	20501200	60,65	64,76	87,25	96,27
12,5	295	20501250	63,55	83,63	108,02	117,02
13	295	20501300	60,97	83,63	108,02	117,02

CL 111-2



STANDARD



CL 110-2

FORI PROFONDI
DEEP HOLE



DIN 1412 C

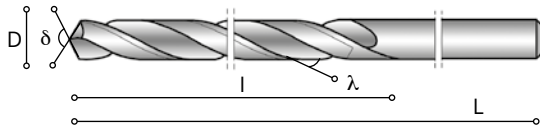

CL111-2



CL110-2



Dal $\varnothing 2$ al $\varnothing 8 = 5$ pz
Dal $\varnothing 8,25$ al $\varnothing 13 = 1$ pz

D h8	L	I	CODE	HSS 5111..... €	HSS+5%Co 5110..... €	HSS+5%Co 6110..... € QUARTZ	HSS+5%Co 7110..... € TITANITE
3	190	13020300	12,12	17,94	26,02	29,47
3,25	200	13520325	15,66	22,47	31,13	34,66
3,5	210	14520350	13,62	19,34	27,68	31,21
3,75	210	14520375	15,66	22,03	30,52	33,98
4	220	15020400	13,69	18,96	28,09	32,05
4,25	220	15020425	21,18	28,33	39,56	44,18
4,5	235	16020450	16,53	22,51	35,13	40,92
4,75	235	16020475	22,11	28,33	41,55	47,33
5	245	17020500	17,01	21,18	33,67	39,46
5,25	245	17020525	22,81	31,64	45,17	50,96
5,5	260	18020550	23,29	28,42	41,84	47,75
5,75	260	18020575	22,51	31,64	45,17	50,96
6	260	18020600	20,72	27,86	41,02	46,81
6,25	275	19020625	30,05	33,04	51,82	60,11
6,5	275	19020650	25,03	30,78	49,26	57,55
6,75	290	20020675	30,61	38,15	56,41	64,54
7	290	20020700	26,91	35,16	53,41	61,70
7,25	290	20020725	35,02	45,71	64,72	72,86
7,5	290	20020750	31,32	40,99	59,53	67,66
7,75	305	21020775	36,59	45,71	71,95	84,15
8	305	21020800	35,41	39,89	65,56	77,76
8,25	305	21020825	46,26	66,49	94,81	107,01
8,5	305	21020850	47,45	60,42	88,15	100,34
8,75	320	22020875	46,26	66,49	94,81	107,01
9	320	22020900	43,82	58,06	85,54	97,74
9,25	320	22020925	54,91	79,76	109,41	121,61
9,5	320	22020950	53,73	69,39	98,02	110,22
9,75	340	23520975	56,03	83,08	113,06	125,26
10	340	23521000	50,43	63,81	91,87	104,06
10,5	340	23521050	65,85	88,89	121,83	135,33
11	365	25021100	75,60	79,76	123,80	144,06
11,5	365	25021150	84,18	102,44	148,74	169,00
12	375	26021200	84,18	89,93	134,98	155,24
12,5	375	26021250	89,84	98,97	144,94	165,20
13	375	26021300	87,87	102,44	148,74	169,00

CL 111-3



25°-30°



STANDARD



CL 110-3

FORI PROFONDI
DEEP HOLE



35°-40°



DIN 1412 C

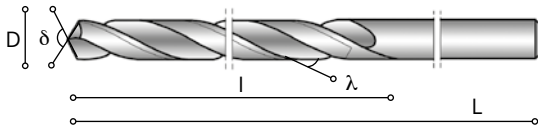

CL111-3



CL110-3



Dal Ø 3,5 al Ø 8 = 5 pz
Dal Ø 8,25 al Ø 13 = 1 pz

D h8	L	I	CODE	HSS 5111..... €	HSS+5%Co 5110..... €	HSS+5%Co 6110..... € QUARTZ	HSS+5%Co 7110..... € TITANITE
3,5	265	18030350	19,43	26,15	40,27	46,60
3,75	265	18030375	20,31	29,68	44,16	50,49
4	280	19030400	18,63	26,15	40,27	46,60
4,25	280	19030425	26,12	35,41	52,44	59,97
4,5	295	20030450	23,29	31,87	48,55	56,06
4,75	295	20030475	24,79	35,41	52,44	59,97
5	315	21030500	19,82	30,74	54,46	65,94
5,25	315	21030525	36,65	37,85	61,86	73,13
5,5	330	22530550	26,44	34,30	57,96	69,24
5,75	330	22530575	27,69	38,32	62,38	73,66
6	330	22530600	26,56	34,47	58,14	69,42
6,25	350	23530625	34,30	43,50	69,96	82,41
6,5	350	23530650	31,16	39,34	64,95	77,15
6,75	370	25030675	40,83	54,13	92,05	110,37
7	370	25030700	39,40	50,66	88,22	106,56
7,25	370	25030725	46,65	60,97	99,57	117,90
7,5	370	25030750	44,91	56,87	95,06	113,40
7,75	390	26530775	46,97	67,51	106,76	125,08
8	390	26530800	45,71	59,09	97,49	115,82
8,25	390	26530825	67,57	80,71	121,28	139,62
8,5	390	26530850	65,22	73,95	113,84	132,18
8,75	410	28030875	70,25	84,96	142,23	169,69
9	410	28030900	65,64	78,52	135,13	162,60
9,25	410	28030925	79,29	99,75	158,50	185,96
9,5	410	28030950	72,30	92,28	150,28	177,74
9,75	430	29530975	78,12	107,15	166,64	194,10
10	430	29531000	71,50	89,93	147,69	175,16
10,5	430	29531050	76,86	94,47	158,03	188,42
11	455	31031100	87,64	93,38	183,86	229,44
11,5	455	31031150	94,25	105,88	197,63	243,19
12	480	33031200	93,23	109,41	201,50	247,08
12,5	480	33031250	98,11	122,57	217,18	263,44
13	480	33031300	101,01	123,76	218,51	264,77

CL 150



N

 λ

25°-30°

 δ
118°

STANDARD

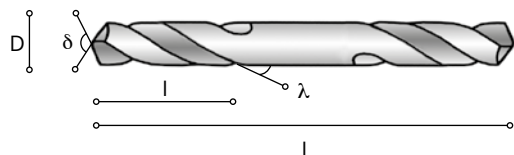

CL150



D h8	L	l	CODE	HSS 5150..... €
2,2	40	1300220	3,21
2,4	43	1400240	3,21
2,5	43	1400250	3,21
2,8	46	1600280	3,21
3	46	1600300	3,21
3,1	49	1800310	3,11
3,2	49	1800320	3,11
3,4	52	2000340	3,20
3,5	52	2000350	3,37
3,7	52	2000370	3,37
3,8	55	2200380	3,43
4	55	2200400	3,43
4,1	55	2200410	3,43
4,2	55	2200420	3,43
4,3	58	2400430	7,22
4,4	58	2400440	7,22
4,5	58	2400450	4,58
4,6	58	2400460	7,07
4,9	62	2600490	7,07
5	62	2600500	5,14
5,2	62	2600520	7,22
5,3	62	2600530	7,22
5,5	66	2800550	6,18
5,6	66	2800560	9,64
5,8	66	2800580	9,64
6	66	2800600	6,81

CL 102



25°-30°



DIN 1412 A

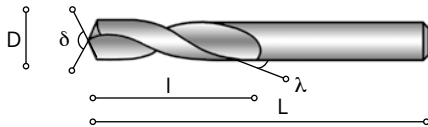

CL102

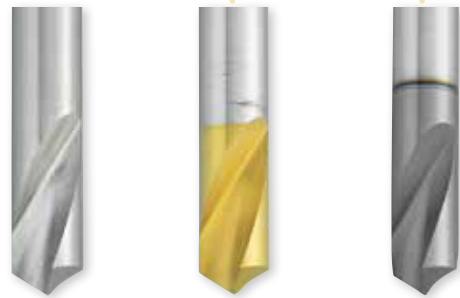

D h6	L	l	CODE	HSS+8%Co 5102..... €	HSS+8%Co 6102..... € QUARTZ	HSS+8%Co 7102..... € TITANITE
6	66	2000060	18,33	22,80	24,84
8	79	2500080	20,93	27,00	30,05
10	89	2501000	21,56	28,57	32,37
12	102	3001200	29,67	38,89	43,72
16	115	3501600	46,54	58,88	64,93
20	131	4002000	80,22	98,08	105,66

CL 103



25°-30°



DIN 1412 A

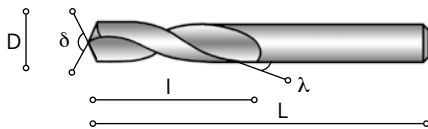

CL103

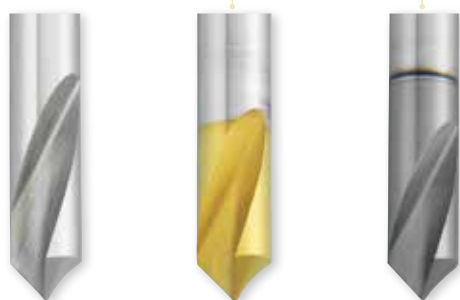

D h6	L	l	CODE	HSS+8%Co 5103..... €	HSS+8%Co 6103..... € QUARTZ	HSS+8%Co 7103..... € TITANITE
6	66	2000060	18,33	22,80	24,84
8	79	2500080	20,93	27,00	30,05
10	89	2501000	21,56	28,57	32,37
12	102	3001200	29,67	38,89	43,72
16	115	3501600	46,54	58,88	64,93
20	131	4002000	81,77	98,08	105,66

CL 910

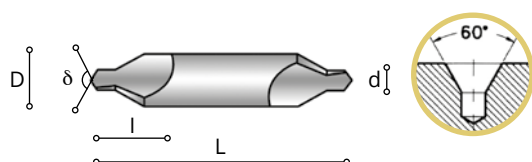

d k13	D h9	L	CODE	HSS 5910..... €	HSS 6910..... € QUARTZ
1	3,15	31,500100	6,84	9,49
1,25	3,15	31,500125	6,72	9,40
1,6	4	35,500160	6,52	9,19
2	5	4000200	7,06	10,49
2,5	6,3	4500250	7,96	11,99
3,15	8	5000315	9,45	13,62
4	10	5600400	15,58	21,01
5	12,5	6300500	22,33	28,76
6,3	16	7100630	32,02	39,42

CL 920

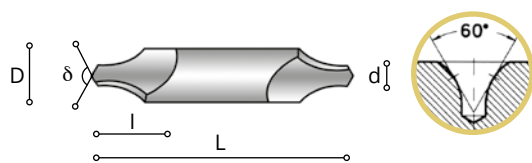

d k13	D h9	L	CODE	HSS 5920..... €	HSS 6920..... € QUARTZ
1	3,15	31,500100	6,99	9,66
1,25	3,15	31,500125	6,89	9,58
1,6	4	35,500160	5,61	8,20
2	5	4000200	9,01	12,62
2,5	6,3	4500250	9,60	13,79
3,15	8	5000315	10,28	14,55
4	10	5600400	16,06	21,52
5	12,5	6300500	23,59	30,15
6,3	16	7100630	33,68	41,25

CL 930

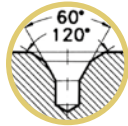
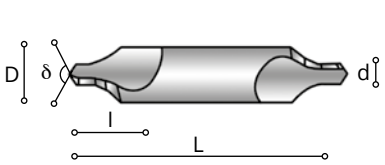

CL930

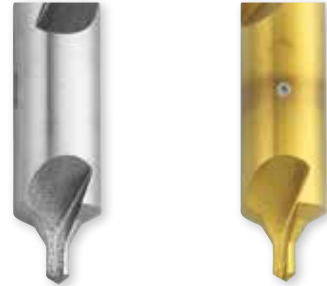

d k13	D h9	L	CODE	HSS 5930..... €	HSS 6930..... € QUARTZ
1	4	35,500100	11,18	14,24
1,25	5	4000125	11,41	15,17
1,6	6,3	4500160	11,75	16,15
2	8	5000200	11,75	16,15
2,5	10	5600250	16,13	21,57
3,15	11,2	6000315	20,06	25,90
4	14	6700400	29,02	36,09
5	18	7500500	40,32	49,83
6,3	20	8000630	51,84	64,39

CL 270



DIN 1412 A

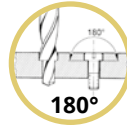
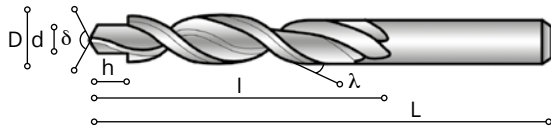

CL270



VITE SCREW	D h8	d h9	L	l	h	CODE	HSS 5270..... €
M3	6	3,4	93	57	900003	44,54
M4	8	4,5	117	75	1100004	51,92
M5	10	5,5	133	87	1300005	59,86
M6	11	6,6	142	94	1500006	66,83
M8	15	9	169	114	1900008	97,05
M10	18	11	191	130	2300010	171,64

CL 271



DIN 1412 A

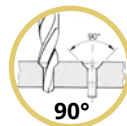
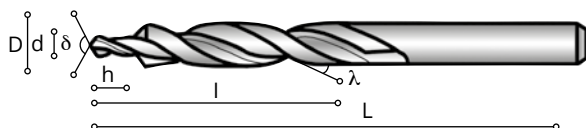

CL271



VITE SCREW	D h8	d h9	L	l	h	CODE	HSS 5271..... €
M3	6	3,2	93	57	900003	42,21
M4	8	4,3	117	75	1100004	51,11
M5	10	5,3	133	87	1300005	64,20
M6	11,5	6,4	142	94	1500006	75,84
M8	15	8,4	169	114	1900008	125,83

CL 272



DIN 1412 A

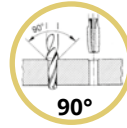
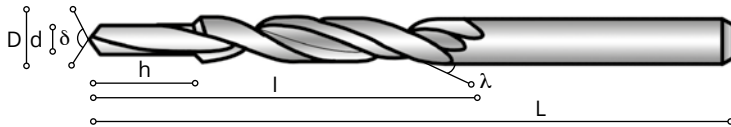

CL272



VITE SCREW	D h8	d h9	L	l	h	CODE	HSS 5272..... €
M3	3,4	2,5	70	39	8,800003	38,53
M4	4,5	3,3	80	47	11,400004	40,52
M5	5,5	4,2	93	57	13,600005	42,05
M6	6,6	5	101	63	16,500006	45,25
M8	9	6,8	125	81	2100008	51,11
M10	11	8,5	142	94	25,500010	68,60
M12	13,5	10,2	160	108	3000012	88,28

CM 300



STANDARD



CM 303



STANDARD

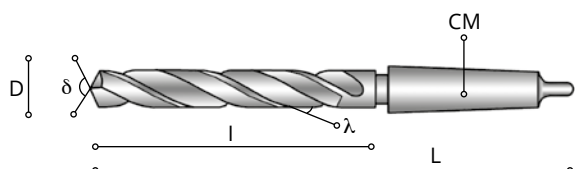

CM300



CM303



CM 300 dal diametro 3 al diametro 5,9 fino ad esaurimento
CM 300 from diameter 3,00 to diameter 5,9 until stocks last.

D h8	L	I	CM	CODE	HSS 5300..... €	HSS+5%Co 5303..... €	HSS+5%Co 6303..... € QUARTZ	HSS+5%Co 7303..... € TITANITE
3	114	33	100300	19,04			
3,10	117	36	100310	24,07			
3,20	117	36	100320	24,07			
3,25	117	36	100325	22,24			
3,30	117	36	100330	25,81			
3,40	120	39	100340	25,81			
3,50	120	39	100350	18,28			
3,60	120	39	100360	24,59			
3,70	120	39	100370	24,59			
3,75	120	39	100375	21,82			
3,80	124	43	100380	24,72			
3,90	124	43	100390	24,72			
4,00	124	43	100400	17,36			
4,10	124	43	100410	24,22			
4,20	124	43	100420	24,22			
4,25	124	43	100425	21,78			
4,30	128	47	100430	24,22			
4,40	128	47	100440	24,22			
4,50	128	47	100450	17,21			
4,60	128	47	100460	24,22			
4,70	128	47	100470	24,22			
4,75	128	47	100475	21,78			
4,80	133	52	100480	24,67			
4,90	133	52	100490	24,67			
5,00	133	52	100500	15,69	34,80	44,23	49,40
5,10	133	52	100510	25,67			
5,20	133	52	100520	25,67			
5,25	133	52	100525	21,59			
5,30	133	52	100530	25,67			
5,40	138	57	100540	25,67			
5,50	138	57	100550	16,34	34,18	44,43	49,71
5,60	138	57	100560	25,19			
5,70	138	57	100570	25,19			
5,75	138	57	100575	21,03			
5,80	138	57	100580	25,19			
5,90	138	57	100590	25,19			
6,00	138	57	100600	14,68	34,18	44,43	49,71
6,10	144	63	100610	25,25			
6,20	144	63	100620	25,25			
6,25	144	63	100625	21,81			

D h8	L	I	CM	CODE	HSS 5300..... €	HSS+5%Co 5303..... €	HSS+5%Co 6303..... € QUARTZ	HSS+5%Co 7303..... € TITANITE
6,30	144	63	100630	25,25			
6,40	144	63	100640	25,25			
6,50	144	63	100650	14,36	31,73	43,40	49,93
6,60	144	63	100660	25,25			
6,70	144	63	100670	25,25			
6,75	150	69	100675	17,25			
6,80	150	69	100680	25,25			
6,90	150	69	100690	25,25			
7,00	150	69	100700	15,29	32,44	44,00	50,40
7,10	150	69	100710	26,36			
7,20	150	69	100720	26,36			
7,25	150	69	100725	20,78			
7,30	150	69	100730	26,36			
7,40	150	69	100740	26,36			
7,50	150	69	100750	16,20	34,97	46,94	53,48
7,60	156	75	100760	26,83			
7,70	156	75	100770	26,83			
7,75	156	75	100775	20,78			
7,80	156	75	100780	26,83			
7,90	156	75	100790	26,83			
8,00	156	75	100800	14,79	31,24	42,68	49,08
8,10	156	75	100810	21,53			
8,20	156	75	100820	21,53			
8,25	156	75	100825	20,09			
8,30	156	75	100830	21,53			
8,40	156	75	100840	21,53			
8,50	156	75	100850	15,11	35,07	46,94	53,60
8,60	162	81	100860	23,04			
8,70	162	81	100870	23,04			
8,75	162	81	100875	21,26			
8,80	162	81	100880	23,04			
8,90	162	81	100890	23,04			
9,00	162	81	100900	15,43	37,99	50,13	56,53
9,10	162	81	100910	28,26			
9,20	162	81	100920	28,26			
9,25	162	81	100925	22,37			
9,30	162	81	100930	28,26			
9,40	162	81	100940	28,26			
9,50	162	81	100950	15,43	39,35	51,60	57,99
9,60	168	87	100960	28,26			
9,70	168	87	100970	28,26			
9,75	168	87	100975	23,69			
9,80	168	87	100980	28,26			
9,90	168	87	100990	28,26			
10,00	168	87	101000	16,05	38,48	50,63	57,05
10,10	168	87	101010	22,46			
10,20	168	87	101020	22,46			
10,25	168	87	101025	21,74			
10,30	168	87	101030	22,99			
10,40	168	87	101040	22,99			
10,50	168	87	101050	19,21	41,23	53,67	60,07
10,60	168	87	101060	25,03			
10,70	175	94	101070	25,03			
10,75	175	94	101075	22,78			
10,80	175	94	101080	24,95			
10,90	175	94	101090	24,95			
11,00	175	94	101100	18,81	40,70	53,24	59,78
11,10	175	94	101110	25,72			
11,20	175	94	101120	25,72			
11,25	175	94	101125	22,74			

CM 300



CM 303

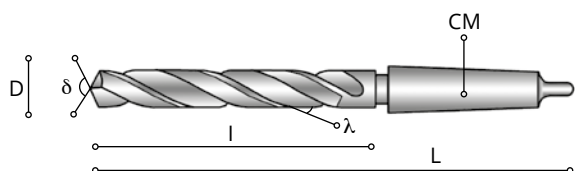

CM300



CM303



D h8	L	I	CM	CODE	HSS 5300..... €	HSS+5%Co 5303..... €	HSS+5%Co 6303..... € QUARTZ	HSS+5%Co 7303..... € TITANITE
11,30	175	94	101130	26,89			
11,40	175	94	101140	26,89			
11,50	175	94	101150	20,46	43,42	56,24	62,79
11,60	175	94	101160	25,32			
11,70	175	94	101170	25,32			
11,75	175	94	101175	22,74			
11,80	175	94	101180	26,36			
11,90	182	101	101190	26,36			
12,00	182	101	101200	20,86	42,05	58,56	68,05
12,10	182	101	101210	26,44			
12,20	182	101	101220	26,44			
12,25	182	101	101225	25,17			
12,30	182	101	101230	26,44			
12,40	182	101	101240	26,44			
12,50	182	101	101250	22,11	47,58	64,64	74,13
12,60	182	101	101260	26,44			
12,70	182	101	101270	26,64			
12,75	182	101	101275	23,37			
12,80	182	101	101280	29,28			
12,90	182	101	101290	29,28			
13,00	182	101	101300	23,15	46,31	63,01	72,31
13,20	182	101	101320	31,83			
13,25	189	108	101325	26,19			
13,50	189	108	101350	26,19	64,74	83,27	92,58
13,75	189	108	101375	26,19			
13,80	189	108	101380	31,83			
14,00	189	108	101400	27,56	62,46	80,76	90,07
14,25	212	114	201425	31,38			
14,50	212	114	201450	30,38	70,06	97,11	112,59
14,75	212	114	201475	32,44			
15,00	212	114	201500	32,44	63,50	89,90	105,38
15,25	218	120	201525	33,66			
15,50	218	120	201550	34,49	71,58	98,79	114,27
15,75	218	120	201575	33,97			
16,00	218	120	201600	31,38	68,53	95,44	110,91
16,25	223	125	201625	37,01			
16,50	223	125	201650	35,49	72,81	100,14	115,61
16,75	223	125	201675	37,01			
17,00	223	125	201700	34,72	68,99	95,94	111,42
17,25	228	130	201725	37,77			

D h8	L	I	CM	CODE	HSS 5300..... €	HSS+5%Co 5303..... €	HSS+5%Co 6303..... € QUARTZ	HSS+5%Co 7303..... € TITANITE
17,50	228	130	201750	37,77	75,85	103,49	118,95
17,75	228	130	201775	39,14			
18,00	228	130	201800	39,24	71,29	98,47	113,94
18,25	233	135	201825	42,34			
18,50	233	135	201850	41,43	78,91	116,33	139,13
18,75	233	135	201875	42,34			
19,00	233	135	201900	42,40	74,57	111,54	134,33
19,25	238	140	201925	45,23			
19,50	238	140	201950	43,56	89,02	127,45	150,25
19,75	238	140	201975	47,15			
20,00	238	140	202000	44,46	87,27	124,95	147,30
20,25	243	145	202025	50,73			
20,50	243	145	202050	50,73	105,34	145,39	168,19
20,75	243	145	202075	52,70			
21,00	243	145	202100	50,73	101,72	141,27	163,96
21,25	248	150	202125	56,36			
21,50	248	150	202150	56,36	112,26	152,42	174,77
21,75	248	150	202175	58,55			
22,00	248	150	202200	58,55	106,82	146,86	169,57
22,25	248	150	202225	59,70			
22,50	253	155	202250	59,70	130,33	191,48	228,62
22,75	253	155	202275	63,98			
23,00	253	155	202300	63,82	126,23	186,96	224,11
23,25	276	155	302325	67,47			
23,50	276	155	302350	64,58	136,05	197,76	234,91
23,75	281	160	302375	76,31			
24,00	281	160	302400	67,62	139,45	201,52	238,66
24,25	281	160	302425	77,52			
24,50	281	160	302450	73,18	148,04	.	.
24,75	281	160	302475	81,49			
25,00	281	160	302500	71,25	143,33	.	.
25,25	286	165	302525	86,66			
25,50	286	165	302550	83,46	178,96	.	.
25,75	286	165	302575	90,62			
26,00	286	165	302600	84,83	169,83	.	.
26,25	286	165	302625	91,54			
26,50	286	165	302650	85,29	189,02	.	.
26,75	291	170	302675	97,93			
27,00	291	170	302700	91,23	187,03	.	.
27,25	291	170	302725	101,90			
27,50	291	170	302750	91,46	222,07	.	.
27,75	291	170	302775	102,05			
28,00	291	170	302800	93,82	192,06	.	.
28,25	296	175	302825	108,75			
28,50	296	175	302850	101,44	233,33	.	.
28,75	296	175	302875	110,73			
29,00	296	175	302900	98,24	201,20	.	.
29,25	296	175	302925	112,41			
29,50	296	175	302950	102,70	243,55	.	.
29,75	296	175	302975	112,41			
30,00	296	175	303000	102,06	212,93	.	.
30,25	301	180	303025	128,09			
30,50	301	180	303050	128,09	258,17	.	.
30,75	301	180	303075	128,09			
31,00	301	180	303100	122,46	258,17	.	.
31,25	301	180	303125	134,34			
31,50	301	180	303150	134,34	283,00	.	.
31,75	306	185	303175	134,34			
32,00	334	185	403200	134,03	282,23	.	.
32,50	334	185	403250	144,24	341,17	.	.

● a richiesta - on demand

CM 300



CM 303

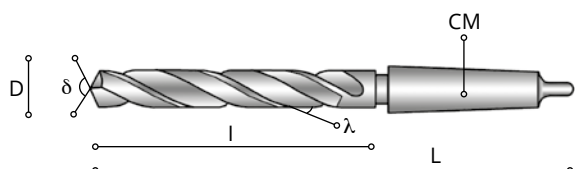

CM300



CM303



D h8	L	I	CM	CODE	HSS 5300..... €	HSS+5%Co 5303..... €	HSS+5%Co 6303..... € QUARTZ	HSS+5%Co 7303..... € TITANITE
33,00	334	185	403300	143,17	341,17	•	•
33,50	334	185	403350	160,23	388,54	•	•
34,00	339	190	403400	160,07	370,87	•	•
34,50	339	190	403450	179,88	370,87	•	•
35,00	339	190	403500	160,07	370,87	•	•
35,50	339	190	403550	181,40	447,03	•	•
36,00	344	195	403600	182,47	447,03	•	•
36,50	344	195	403650	195,87	466,83	•	•
37,00	344	195	403700	188,71	466,83	•	•
37,50	344	195	403750	207,60	535,37	•	•
38,00	349	200	403800	206,08	535,37	•	•
38,50	349	200	403850	249,48	556,08	•	•
39,00	349	200	403900	206,04	556,08	•	•
39,50	349	200	403950	251,77	556,08	•	•
40,00	349	200	404000	221,61	538,41	•	•
40,50	354	205	404050	264,87	553,39	•	•
41,00	354	205	404100	245,52	553,57	•	•
41,50	354	205	404150	283,15	580,65	•	•
42,00	354	205	404200	256,03	578,27	•	•
42,50	354	205	404250	289,54	650,59	•	•
43,00	359	210	404300	280,86	641,58	•	•
43,50	359	210	404350	319,09	665,26	•	•
44,00	359	210	404400	287,26	662,96	•	•
44,50	359	210	404450	341,79	723,98	•	•
45,00	359	210	404500	304,77	709,60	•	•
45,50	364	215	404550	345,59	724,95	•	•
46,00	364	215	404600	308,13	717,91	•	•
46,50	364	215	404650	388,08	759,08	•	•
47,00	364	215	404700	325,64	754,30	•	•
47,50	364	215	404750	397,68	783,37	•	•
48,00	369	220	404800	355,49	778,47	•	•
48,50	369	220	404850	412,46	800,13	•	•
49,00	369	220	404900	364,93	800,13	•	•
49,50	369	220	404950	417,48	838,46	•	•
50,00	369	220	405000	373,15	838,46	•	•
50,50	374	225	405050	438,50			
51	412	225	505100	457,84			
52	412	225	505200	473,99			
53	412	225	505300	479,78			
54	417	230	505400	516,17			

• a richiesta - on demand

D h8	L	I	CM	CODE	HSS 5300..... €	HSS+5%Co 5303..... €	HSS+5%Co 6303..... € QUARTZ	HSS+5%Co 7303..... € TITANITE
55	417	230	505500	524,56			
56	417	230	505600	524,56			
57	422	235	505700	555,62			
58	422	235	505800	587,15			
59	422	235	505900	587,15			
60	422	235	506000	608,18			
61	427	240	506100	649,68			
62	427	240	506200	672,06			
63	427	240	506300	712,98			
64	432	245	506400	730,53			
65	432	245	506500	772,77			
66	432	245	506600	828,31			
67	432	245	506700	828,31			
68	437	250	506800	889,60			
69	437	250	506900	944,48			
70	437	250	507000	973,05			
71	437	250	507100	993,43			
72	442	255	507200	1062,31			
73	442	255	507300	1105,40			
74	442	255	507400	1155,94			
75	442	255	507500	1185,64			
76	447	260	507600	1284,88			
77	514	260	607700	1437,48			
78	514	260	607800	1465,67			
79	514	260	607900	1533,49			
80	514	260	608000	1568,15			
85	519	265	608500	2017,01			
90	524	270	609000	2154,09			
95	529	275	609500	2608,93			
100	534	280	610000	2859,58			

CM 301



STANDARD



CM 302



DIN 1412 C



FORI PROFONDI
DEEP HOLE

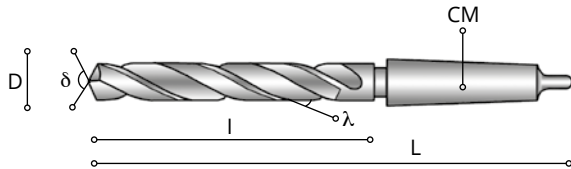

CM301



CM302



D h8	L	I	CM	CODE	HSS	HSS+5%Co	HSS+5%Co	HSS+5%Co
					5301..... €	5302..... €	6302..... € QUARTZ	7302..... € TITANITE
8	181	100	100800	29,25	48,06	65,64	76,53
8,5	181	100	100850	26,80	49,75	67,47	78,35
9	188	107	100900	30,58	57,03	75,27	86,16
9,5	188	107	100950	33,38	59,47	77,89	88,79
10	197	116	101000	34,71	60,04	78,51	89,39
10,5	197	116	101050	35,94	64,19	82,96	93,84
11	206	125	101100	36,91	69,20	88,32	99,21
11,5	206	125	101150	36,91	74,39	93,89	104,78
12	215	134	101200	36,91	75,05	98,39	112,18
12,5	215	134	101250	37,95	78,17	101,72	115,52
13	215	134	101300	38,09	84,20	108,19	121,99
13,5	223	142	101350	42,68	92,46	116,19	129,40
14	223	142	101400	45,57	97,07	121,13	134,33
14,5	245	147	201450	56,63	113,17	143,70	161,03
15	245	147	201500	56,63	116,35	147,09	164,42
15,5	251	153	201550	62,07	121,85	159,87	170,33
16	251	153	201600	62,07	127,10	165,50	175,95
16,5	257	159	201650	65,13	136,87	175,95	186,41
17	257	159	201700	65,13	144,38	184,00	194,46
17,5	263	165	201750	72,62	150,90	190,98	201,44
18	263	165	201800	69,56	159,67	200,39	210,84
18,5	269	171	201850	79,25	163,74	217,01	249,12
19	269	171	201900	73,63	172,70	226,62	258,73
19,5	275	177	201950	86,05	182,20	236,79	268,89
20	275	177	202000	79,42	188,71	243,77	275,88
20,5	282	184	202050	86,72			
21	282	184	202100	103,56	197,29	252,96	285,06
21,5	289	191	202150	107,14			
22	289	191	202200	103,56	208,25	264,69	296,82
22,5	296	198	202250	111,04			
23	296	198	202300	111,37	230,18	299,69	340,68
23,5	319	198	302350	121,33			
24	327	206	302400	137,81	251,25	338,20	391,48
24,5	327	206	302450	147,95			
25	327	206	302500	137,81	276,56	•	•
25,5	335	214	302550	147,95			
26	335	214	302600	143,70	294,02	•	•
26,5	335	214	302650	152,19			
27	343	222	302700	164,80	340,95	•	•
27,5	343	222	302750	166,66			

• a richiesta - on demand

D h8	L	I	CM	CODE	HSS 5301..... €	HSS+5%Co 5302..... €	HSS+5%Co 6302..... € QUARTZ	HSS+5%Co 7302..... € TITANITE
28	343	222	302800	174,86	353,87	•	•
28,5	351	230	302850	188,93			
29	351	230	302900	188,76	381,04	•	•
29,5	351	230	302950	204,41			
30	351	230	303000	195,05	407,09	•	•

● a richiesta - on demand

CM 304



CM 306

FORI PROFONDI
DEEP HOLE

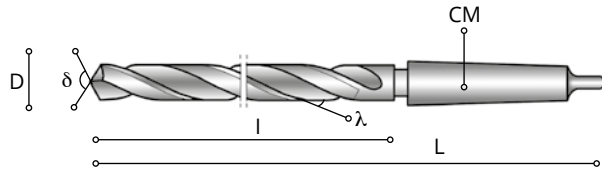

CM304



CM306



D h8	L	I	CM	CODE	HSS 5304..... €	HSS+5%Co 5306..... €	HSS+5%Co 6306..... € QUARTZ	HSS+5%Co 7306..... € TITANITE
8	265	165	100800	51,48	82,58	112,17	128,65
8,5	265	165	100850	57,71	98,96	130,19	146,65
9	275	175	100900	62,46	97,43	129,41	146,55
9,5	275	175	100950	67,23	105,26	137,11	153,57
10	285	185	101000	63,85	98,55	129,74	146,21
10,5	285	185	101050	71,59	121,51	155,00	171,46
11	300	195	101100	87,43	111,64	147,67	166,87
11,5	300	195	101150	91,31	113,74	149,99	169,21
12	310	205	101200	92,45	118,13	163,79	182,78
12,5	310	205	101250	91,70	135,61	178,19	194,46
13	310	205	101300	94,12	130,68	172,75	189,02
13,5	325	220	101350	96,65	147,23	190,97	207,24
14	325	220	101400	96,65	150,20	194,21	210,48
14,5	340	220	201450	101,95	164,30	222,53	246,13
15	340	220	201500	104,44	166,56	225,03	248,62
15,5	355	230	201550	122,46	183,52	264,55	299,93
16	355	230	201600	117,06	184,00	265,10	300,47
16,5	355	230	201650	127,76	193,66	275,72	311,09
17	355	230	201700	127,76	200,54	283,29	318,68
17,5	370	245	201750	151,31	212,79	•	•
18	370	245	201800	138,13	221,65	•	•
18,5	370	245	201850	142,76	239,27	•	•
19	370	245	201900	149,39	239,67	•	•
19,5	385	260	201950	159,37	266,97	•	•
20	385	260	202000	163,28	265,74	•	•
20,5	385	260	202050	175,00	335,54	•	•
21	385	260	202100	185,63	317,64	•	•
21,5	405	270	202150	217,89	363,03	•	•
22	405	270	202200	205,21	347,46	•	•
22,5	405	270	202250	237,26	386,42	•	•
23	405	270	202300	226,39	376,47	•	•
23,5	425	270	302350	280,80	472,21	•	•
24	440	290	302400	255,66	431,20	•	•
24,5	440	290	302450	299,12	509,48	•	•
25	440	290	302500	270,88	446,89	•	•
25,5	440	290	302550	323,86	542,08	•	•
26	440	290	302600	290,74	491,28	•	•
26,5	440	290	302650	342,76	550,48	•	•
27	460	305	302700	300,42	510,23	•	•
27,5	460	305	302750	336,56	598,86	•	•

• a richiesta - on demand

D h8	L	I	CM	CODE	HSS 5304..... €	HSS+5%Co 5306..... €	HSS+5%Co 6306..... € QUARTZ	HSS+5%Co 7306..... € TITANITE
28	460	305	302800	323,22	540,97	•	•
28,5	460	305	302850	379,77	635,46	•	•
29	460	305	302900	342,76	581,07	•	•
29,5	460	305	302950	388,82	646,45	•	•
30	460	305	303000	372,36	614,13	•	•
30,5	480	320	303050	443,29			
31	480	320	303100	402,64	733,22	•	•
32	505	320	403200	430,95			
33	505	320	403300	475,04			
34	530	340	403400	504,14			
35	530	340	403500	512,32			
36	530	340	403600	544,74			
37	530	340	403700	562,91			
38	555	360	403800	591,39			
39	555	360	403900	613,34			
40	555	360	404000	652,59			
41	555	360	404100	697,97			
42	555	360	404200	721,22			
43	585	385	404300	806,60			
44	585	385	404400	837,67			
45	585	385	404500	883,39			
46	585	385	404600	927,19			
47	585	385	404700	976,59			
48	605	405	404800	1072,72			
49	605	405	404900	1126,28			
50	605	405	405000	1177,71			

● a richiesta - on demand

CM 305



STANDARD



CM 307

FORI PROFONDI
DEEP HOLE



DIN 1412 C

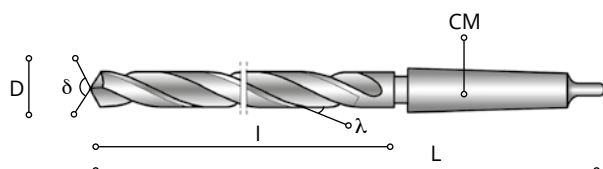

CM305



CM307



D h8	L	I	CM	CODE	HSS 5305..... €	HSS+5%Co 5307..... €
8	330	210	100800	75,15	120,72
8,5	330	210	100850	82,12	135,11
9	345	220	100900	87,98	139,94
9,5	345	220	100950	92,94	154,42
10	360	235	101000	84,60	138,58
10,5	360	235	101050	100,48	170,80
11	375	250	101100	106,74	162,61
11,5	375	250	101150	114,07	174,14
12	395	260	101200	109,67	174,14
12,5	395	260	101250	121,61	193,57
13	395	260	101300	126,20	187,83
13,5	410	275	101350	138,86	211,69
14	410	275	101400	142,70	210,41
14,5	425	275	201450	148,92	231,41
15	425	275	201500	148,92	231,41
15,5	445	295	201550	161,56	247,25
16	445	295	201600	158,39	254,36
16,5	445	295	201650	167,23	272,30
17	445	295	201700	176,53	287,37
17,5	465	310	201750	184,39	325,31
18	465	310	201800	195,09	344,21
18,5	465	310	201850	200,12	353,80
19	465	310	201900	210,98	372,27
19,5	490	325	201950	222,62	392,77
20	490	325	202000	230,57	412,67
20,5	490	325	202050	237,17	441,81
21	490	325	202100	241,10	431,50
21,5	515	345	202150	265,99	491,19
22	515	345	202200	265,99	478,83
22,5	515	345	202250	281,63	517,71
23	515	345	202300	288,36	517,71
23,5	535	345	302350	333,36	623,98
24	555	365	302400	315,55	571,65
24,5	555	365	302450	367,17	656,03
25	555	365	302500	351,38	619,31
25,5	555	365	302550	411,54	764,78
26	555	365	302600	385,23	688,19
26,5	555	365	302650	439,20	821,19
27	580	385	302700	414,21	728,48
27,5	580	385	302750	469,79	869,52

D h8	L	I	CM	CODE	HSS 5305..... €	HSS+5%Co 5307..... €
28	580	385	302800	416,89	791,63
28,5	580	385	302850	467,94	905,55
29	580	385	302900	481,78	876,53
29,5	580	385	302950	526,37	966,43
30	580	385	303000	514,65	911,20
31	610	410	303100	547,13	
32	635	410	403200	579,69	
33	635	410	403300	645,85	
34	665	430	403400	645,85	
35	665	430	403500	645,85	
36	665	430	403600	649,06	
37	665	430	403700	734,06	
38	695	460	403800	745,07	
39	695	460	403900	757,77	
40	695	460	404000	770,22	
41	695	460	404100	860,96	
42	695	460	404200	909,64	
43	735	490	404300	997,39	
44	735	490	404400	1026,58	
45	735	490	404500	1061,91	
46	735	490	404600	1114,64	
47	735	490	404700	1173,99	
48	765	510	404800	1289,54	
49	765	510	404900	1353,98	
50	765	510	405000	1415,82	



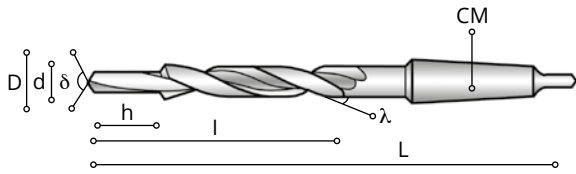

CM 372



CM372



VITE SCREW	D h8	d h9	L	l	h	CM	CODE	HSS 5372..... €
M8	9	6,8	162	81	21	100008	82,32
M10	11	8,5	175	94	25,5	100010	96,29
M12	13,5	10,2	189	108	30	100012	115,07
M14	15,5	12	218	120	34,5	200014	138,33
M16	17,5	14	228	130	38,5	200016	165,54
M18	20	15,5	238	140	43,5	200018	190,00
M20	22	17,5	248	150	47,5	200020	224,43

Articolo Article	Campo d'applicazione Application field	Angolo vertice Point angle	Materiale tipo Tool material	Superficie Surface	Standard	gamma dal (mm) diameter range (mm)	pag page
 SV 77			HSS	White			89
 SV 77			HSS	Quartz			89
CODOLO CONO MORSE MORSE TAPER SHANK							
 SV 72	Acciai tenaci Hardened steel		HSS+5%CO	White	DIN 334 B DIN 335 B	25 - 50	87
SVASATORI PER SEDI DI VITI A TESTA CILINDRICA COUNTERBORES FOR CAPSCREW							
CODOLO CILINDRICO SHANK							
 BR 51	Acciai comuni Standard steel		HSS+5%CO	White	DIN 373	M3 - M20	90
CODOLO CONO MORSE MORSE TAPER SHANK							
 BR 52	Acciai comuni Standard steel		HSS+5%CO	White	DIN 375	M6 - M24	91

FORATURA DRILLING	TABELLA PARAMETRI DI AVANZAMENTO mm/giro RECOMMENDED FEED DATA mm/rev.																
	DIAMETRO DELLA PUNTA DRILL DIAMETER																
LETTERA DI RIFERIMENTO REFERENCE LETTER	D. 1	D. 2	D. 3	D. 4	D. 5	D. 6	D. 8	D. 10	D. 12	D. 14	D. 16	D. 20	D. 25	D. 30	D. 35	D. 40	D. 50
a	0,015	0,030	0,038	0,047	0,053	0,060	0,075	0,090	0,100	0,120	0,127	0,160	0,200	0,230	0,250	0,300	0,350
b	0,020	0,050	0,070	0,085	0,100	0,120	0,150	0,180	0,200	0,230	0,250	0,270	0,290	0,330	0,350	0,380	0,400
c	0,023	0,080	0,100	0,130	0,150	0,180	0,250	0,270	0,280	0,300	0,330	0,370	0,420	0,450	0,470	0,500	0,550
d	0,030	0,100	0,160	0,180	0,220	0,240	0,300	0,370	0,400	0,450	0,480	0,500	0,530	0,550	0,580	0,600	0,630
e	0,035	0,120	0,200	0,250	0,270	0,300	0,350	0,450	0,470	0,500	0,530	0,550	0,600	0,640	0,680	0,700	0,730
f	0,050	0,150	0,220	0,250	0,320	0,400	0,490	0,620	0,650	0,720	0,850	0,900	1,100	1,130	1,170	1,200	1,250
g	0,070	0,160	0,250	0,270	0,360	0,470	0,620	0,830	0,900	0,950	1,100	1,200	1,280	1,330	1,400	1,470	1,520
h	0,090	0,200	0,270	0,300	0,400	0,520	0,750	1,000	1,100	1,200	1,300	1,350	1,430	1,500	1,650	1,700	1,800





max 2 mm

E

30 ± 0.2

5 ± 0.2

15

M 5.1

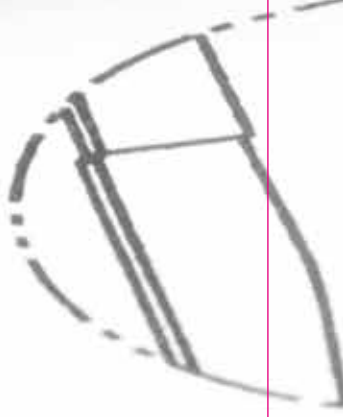

AL 111



7°-10°

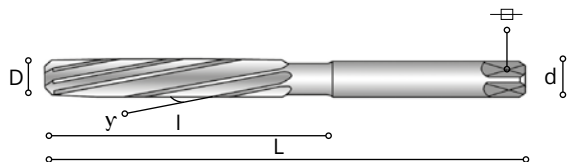

AL111



D H7	L	l	d e9		z	CODE	HSS 1111..... €
3	62	31	3	2,1	403000	31,00
4	76	38	4	3	604000	31,64
5	87	44	5	3,8	650000	35,41
6	93	47	6	4,3	660000	34,68
7	107	54	7	5,5	670000	39,91
8	115	58	8	6,2	680000	43,52
9	124	62	9	7	690000	44,93
10	133	66	10	8	610000	45,96
11	142	71	11	9	611000	52,70
12	152	76	12	10	812000	51,60
13	152	76	13	10	813000	61,99
14	163	81	14	11	814000	60,43
15	163	81	15	11	815000	65,91
16	175	87	16	12	816000	67,47
17	175	87	17	12	817000	83,69
18	188	93	18	14,5	818000	81,22
19	188	93	19	14,5	819000	92,68
20	201	100	20	16	820000	97,44
21	201	100	21	16	821000	113,40
22	215	107	22	18	822000	106,05
23	215	107	23	18	823000	133,57
24	231	115	24	20	824000	126,34
25	231	115	25	20	1025000	135,06
26	231	115	26	20	1026000	146,07
27	247	124	27	22	1027000	186,05
28	247	124	28	22	1028000	170,12
29	247	124	29	22	1029000	194,62
30	247	124	30	22	1030000	185,63
32	265	133	32	24	1032000	206,98
34	284	142	34	29	1034000	227,97
35	284	142	35	29	1035000	241,07
36	284	142	36	29	1036000	253,86
38	305	152	38	32	1238000	294,57
40	305	152	40	32	1240000	327,46

AS 115
CONICITÀ 1:50
TAPER 1:50

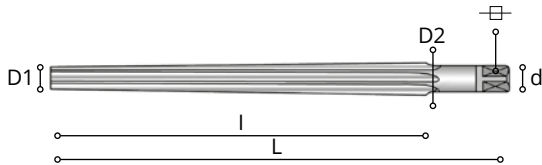

AS115



D Nom.	D1	D2	L	I	d h11		z	CODE	HSS 1115..... €
5	4,9	6,36	100	73	6,3	4,9	550000	49,50
6	5,9	8	135	105	8	6,2	560000	58,33
6,5	6,4	8,6	140	110	8	6,2	565000	65,66
8	7,9	10,8	180	145	10	8	580000	70,70
10	9,9	13,4	215	175	12,5	10	710000	86,62
12	11,8	16	255	210	14	11	712000	118,08
16	15,8	20,4	280	230	18	14,5	916000	180,94
20	19,8	24,8	310	250	22,4	18	920000	376,74

AM 117



7°-10°

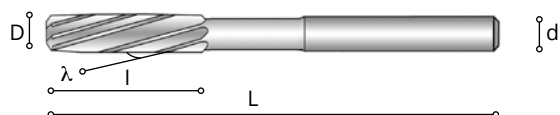

AM117



D H7	L	l	d h9	Z	CODE	HSS+5%Co 1117..... €
2	49	11	2	402000	27,06
2,1	49	11	2,1	421000	31,89
2,2	53	12	2,2	422000	31,89
2,3	53	12	2,3	423000	31,89
2,4	57	14	2,4	424000	31,89
2,5	57	14	2,5	425000	25,61
2,6	57	14	2,6	426000	29,89
2,7	61	15	2,7	427000	29,89
2,8	61	15	2,8	428000	29,89
2,9	61	15	2,9	429000	29,89
3	61	15	3	430000	25,61
3,1	65	16	3,1	431000	31,23
3,2	65	16	3,2	432000	31,23
3,3	65	16	3,3	433000	31,23
3,4	70	18	3,4	434000	31,23
3,5	70	18	3,5	635000	27,07
3,6	70	18	3,6	636000	33,06
3,7	70	18	3,7	637000	33,06
3,8	75	19	4	638000	33,06
3,9	75	19	4	639000	33,06
4	75	19	4	640000	27,07
4,1	75	19	4	641000	33,89
4,2	75	19	4	642000	33,89
4,3	80	21	4,5	643000	33,89
4,4	80	21	4,5	644000	33,89
4,5	80	21	4,5	645000	30,06
4,6	80	21	4,5	646000	35,41
4,7	80	21	4,5	647000	35,41
4,8	86	23	5	648000	35,41
4,9	86	23	5	649000	35,41
5	86	23	5	650000	30,06
5,1	86	23	5	651000	39,22
5,2	86	23	5	652000	39,22
5,3	86	23	5	653000	39,22
5,4	93	26	5,6	654000	39,22
5,5	93	26	5,6	655000	32,34
5,6	93	26	5,6	656000	37,32
5,7	93	26	5,6	657000	37,32
5,8	93	26	5,6	658000	37,32
5,9	93	26	5,6	659000	37,32

D H7	L	I	d h9	Z	CODE	HSS+5%Co 1117..... €
6	93	26	5,6	660000	31,61
6,1	101	28	6,3	661000	41,99
6,2	101	28	6,3	662000	41,99
6,3	101	28	6,3	663000	41,99
6,4	101	28	6,3	664000	41,99
6,5	101	28	6,3	665000	33,15
6,6	101	28	6,3	666000	39,88
6,7	101	28	6,3	667000	39,88
6,8	109	31	7,1	668000	39,88
6,9	109	31	7,1	669000	39,88
7	109	31	7,1	670000	33,15
7,1	109	31	7,1	671000	44,25
7,2	109	31	7,1	672000	44,25
7,3	109	31	7,1	673000	44,25
7,4	109	31	7,1	674000	44,25
7,5	109	31	7,1	675000	34,61
7,6	117	33	8	676000	41,51
7,7	117	33	8	677000	41,51
7,8	117	33	8	678000	41,51
7,9	117	33	8	679000	41,51
8	117	33	8	680000	34,61
8,1	117	33	8	681000	49,38
8,2	117	33	8	682000	49,38
8,3	117	33	8	683000	49,38
8,4	117	33	8	684000	49,38
8,5	117	33	8	685000	39,13
8,6	125	36	9	686000	44,93
8,7	125	36	9	687000	44,93
8,8	125	36	9	688000	44,93
8,9	125	36	9	689000	44,93
9	125	36	9	690000	40,59
9,1	125	36	9	691000	51,44
9,2	125	36	9	692000	51,44
9,3	125	36	9	693000	51,44
9,4	125	36	9	694000	51,44
9,5	125	36	9	695000	42,13
9,6	133	38	10	696000	47,87
9,7	133	38	10	697000	47,87
9,8	133	38	10	698000	47,87
9,9	133	38	10	699000	47,87
10	133	38	10	610000	42,13
11	142	41	10	611000	48,13
12	151	44	10	612000	53,70
13	151	44	10	613000	57,88
14	160	47	12,5	614000	58,64
15	162	50	12,5	815000	63,20
16	170	52	12,5	816000	75,27
17	175	54	14	817000	89,04
18	182	56	14	818000	91,16
19	189	58	16	819000	107,47
20	195	60	16	820000	98,77

AM 112

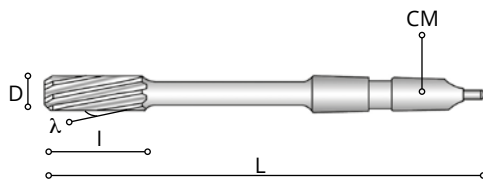
DIN
208/B λ 7°-10°

AM112



DH7	L	l	CM	Z	CODE	HSS+5%Co 1112..... €
5	133	23	1	650000	49,76
6	138	26	1	660000	50,42
7	150	31	1	670000	53,43
8	156	33	1	680000	53,43
9	162	36	1	690000	58,00
10	168	38	1	610000	57,73
11	175	41	1	611000	61,04
12	182	44	1	812000	61,04
13	182	44	1	813000	67,16
14	189	47	1	814000	65,31
15	204	50	2	815000	68,32
16	210	52	2	816000	74,36
17	214	54	2	817000	80,49
18	219	56	2	818000	80,49
19	223	58	2	819000	88,49
20	228	60	2	820000	80,88
21	232	62	2	1021000	93,74
22	237	64	2	1022000	86,85
23	241	66	2	1023000	95,80
24	268	68	3	1024000	100,22
25	268	68	3	1025000	104,91
26	273	70	3	1026000	116,48
27	277	71	3	1027000	130,26
28	277	71	3	1028000	136,53
29	281	73	3	1029000	140,84
30	281	73	3	1030000	141,95
32	317	77	4	1032000	174,09
34	321	78	4	1034000	190,51
35	321	78	4	1235000	206,61
36	325	79	4	1236000	229,36
38	329	81	4	1238000	245,98
40	329	81	4	1240000	263,01

AMM 113



AFE 116



AMM113

AFE116

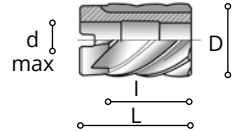
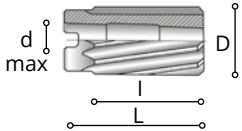

DH7	L	I	d max	AMM113	AFE116	CODE	HSS+5%Co	HSS+5%Co
				Z	Z		1113.....	1116.....
							€	€
20	40	28	10	8	20000	126,34	
21	40	28	10	8	21000	128,25	
22	40	28	10	8	22000	131,45	
23	40	28	10	8	23000	132,97	
24	45	32	13	10	24000	138,68	
25	45	32	13	10	825000	140,20	141,61
26	45	32	13	10	826000	146,07	146,07
27	45	32	13	10	827000	152,84	152,84
28	45	32	13	10	828000	152,84	152,84
29	45	32	13	10	829000	161,60	161,60
30	45	32	13	10	830000	161,60	161,60
31	50	36	16	10	31000	173,06	
32	50	36	16	10	832000	167,96	173,05
33	50	36	16	10	33000	184,30	
34	50	36	16	10	834000	184,30	184,29
35	50	36	16	12	35000	184,30	
36	56	40	19	12	836000	195,64	202,27
37	56	40	19	12	37000	206,79	
38	56	40	19	12	838000	206,79	206,79
39	56	40	19	12	39000	221,39	
40	56	40	19	12	840000	217,19	221,39
42	56	40	19	12	842000	233,72	233,72
44	63	45	22	12	44000	256,22	
45	63	45	22	12	845000	262,96	262,96
46	63	45	22	14	46000	270,85	
48	63	45	22	14	848000	283,19	283,19
50	63	45	22	14	850000	285,47	296,59
52	71	50	27	14	852000	328,11	328,11
55	71	50	27	14	855000	346,13	346,13
56	71	50	27	16	1056000	435,07	435,07
58	71	50	27	16	1058000	368,63	368,63
60	71	50	27	16	1060000	388,85	404,00
62	80	56	32	16	62000	470,29	
65	80	56	32	16	65000	526,88	
68	80	56	32	16	68000	552,80	
70	80	56	32	16	70000	562,79	
72	90	63	40	16	72000	628,97	
75	90	63	40	16	75000	667,76	
78	90	63	40	16	78000	712,43	
80	90	63	40	20	80000	754,73	

MAN 114

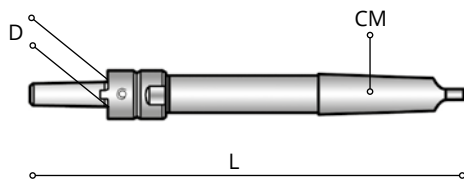
DIN
217/B

MAN114



D	L	CM	CODE	1.5990 - DIN 16CrNi4
				1114..... €
10	216	210000	168,50
13	250	313000	202,25
16	261	316000	219,01
19	298	419000	252,74
22	312	422000	286,49
27	359	427000	320,20
32	345	432000	334,75
40	396	540000	435,64

SV 72

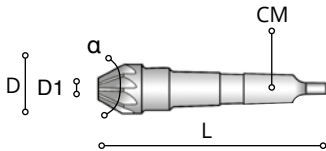

SV72



D	D1	α $+0^\circ$ -1°	L	CM	Z	CODE	HSS+5%Co 1720..... €
25	7	60°	125	2	725600	118,71
31,5	9	60°	132	2	731560	162,16
40	12	60°	160	3	1040600	235,58
50	16	60°	165	3	1250600	323,16
25	7	90°	121	2	725900	118,71
31,5	9	90°	124	2	731590	162,16
40	12	90°	150	3	1040900	235,58
50	16	90°	153	3	1250900	323,16

SV 74

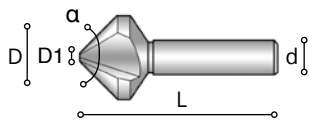

SV74



D	D1z9	α $+0^\circ$ -1°	L	d h9	CODE	HSS+8%Co 1740..... €	HSS+8%Co 2740..... € SAPPHIRE MULTI
10,4	2,5	90°	50	610490	30,32	40,11
11,5	2,8	90°	56	811590	31,42	41,33
12,4	2,8	90°	56	812490	35,12	46,03
15	3,2	90°	60	1015090	38,82	50,08
16,5	3,2	90°	60	1016590	41,40	55,00
19	3,5	90°	63	1019090	49,53	65,65
20,5	3,5	90°	63	1020590	53,61	70,12
23	3,8	90°	67	1023090	69,14	89,66
25	3,8	90°	67	1025090	72,09	92,91
28	4	90°	71	1228090	85,69	112,40
31	4,2	90°	71	1231090	100,93	132,92

SV 75

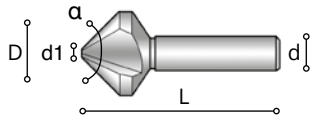

SV 75



D	d	α $+0^\circ$ -1°	d1	L	Code	HSS 1750..... €	HSS 6750..... € Quartz	HSS 2750..... € Sapphire
5,30	4,00	90°	1,5	4005390	8,84	14,40	16,96
6,30	5,00	90°	1,5	4506390	9,60	15,65	18,46
8,30	6,00	90°	2	5008390	11,08	18,61	22,03
10,40	6,00	90°	2,5	5010490	13,30	20,69	24,08
11,50	8,00	90°	2,8	5611590	15,29	24,78	27,68
12,40	8,00	90°	2,8	5612490	16,11	24,68	28,51
15,00	10,00	90°	3,2	6015090	19,23	30,11	35,39
16,50	10,00	90°	3,2	6016590	22,60	32,36	36,80
20,50	10,00	90°	3,5	6320590	32,06	46,10	51,41
25,00	10,00	90°	3,8	6725090	38,71	54,66	62,05
31,00	12,00	90°	4,2	7131090	49,05	69,30	78,75

SV 76

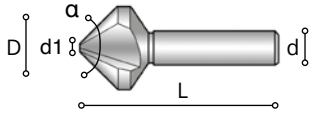

D	d	α $+0^\circ$ -1°	d1	L	Code	HSS+5%Co 1760..... €	HSS+5%Co 6760..... € Quartz	HSS+5%Co 2760..... € Sapphire
6,30	5,00	90°	1,5	4506390	13,90	22,65	25,59
8,30	6,00	90°	2	5008390	15,81	26,55	30,00
10,40	6,00	90°	2,5	5010490	19,95	31,03	35,06
12,40	8,00	90°	2,8	5612490	23,79	36,43	41,16
15,00	10,00	90°	3,2	6015090	31,43	42,03	47,70
16,50	10,00	90°	3,2	6016590	32,20	46,11	52,11
19,00	10,00	90°	3,5	6319090	45,39	56,55	63,13
20,50	10,00	90°	3,5	6320590	46,98	60,05	67,88
23,00	10,00	90°	3,8	6723090	56,21	75,36	85,51
25,00	10,00	90°	3,8	6725090	59,09	79,60	89,76
28,00	12,00	90°	4	7128090	76,56	93,33	108,18
31,00	12,00	90°	4,2	7131090	87,91	117,33	131,85

PUNTE A GRADINO IN ELICA | STEP DRILLS WITH SPIRAL FLUTE

SV 77

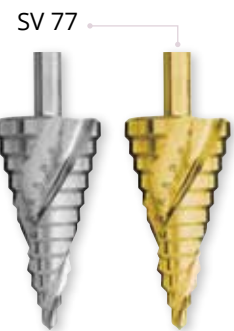
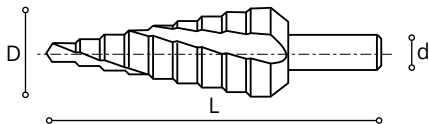

D	d	N° Gradini N° Step	L	Code	HSS 1770 €	HSS 6770 € Quartz
4 - 5 - 6 - 7 - 8 - 9 - 10 - 11 - 12	6	9	6600001	43,41	54,50
4 - 6 - 8 - 10 - 12 - 14 - 16 - 18 - 20	8	9	7700002	57,95	73,64
4 - 6 - 8 - 10 - 12 - 14 - 16 - 18 - 20 - 22 - 24 - 26 - 28 - 30	10	14	10100003	99,68	128,55
4 - 6 - 9 - 12 - 15 - 18 - 21 - 24 - 27 - 30 - 33 - 36 - 39	12	13	10800004	136,33	175,40
6 - 9 - 13 - 16 - 19 - 21 - 23 - 26 - 29 - 32 - 35 - 38	12	12	10000005	135,86	174,84

BR 51

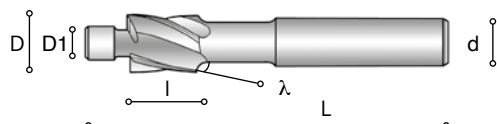

BR51



	D H8	D1 f8	L	l	d h9	Z	CODE	HSS+5%Co 1510..... €
M3	5,9	3,2	71	14	6	330000	35,90
M4	7,4	4,3	71	14	8	340000	35,90
M5	9,4	5,3	80	18	10	350000	38,60
M6	10,4	6,4	80	18	10	360000	40,37
M8	13,5	8,4	100	22	12	380000	50,24
M10	16,5	10,5	100	22	12	310000	63,59
M12	19	13	100	22	16	312000	78,97
M14	23	15	130	30	16	314000	106,80
M16	25	17	150	30	20	316000	134,60
M18	28	19	155	35	20	318000	168,69
M20	31	21	165	35	20	320000	200,11

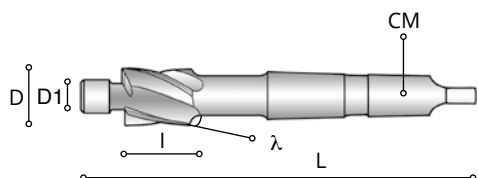

BR 52











































BR52



















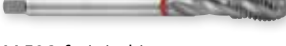











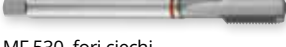

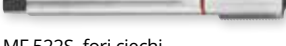



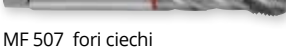

	D H8	D1 f8	L	I	CM	CODE	HSS+5%Co 1520..... €
M6	10,4	6,4	125	18	160000	56,03
M8	13,5	8,4	140	22	180000	64,69
M10	16,5	10,5	150	25	210000	79,63
M12	19	13	150	25	212000	97,29
M14	23	15	160	30	214000	122,54
M16	25	17	160	30	216000	154,60
M18	28	19	190	35	318000	184,02
M20	31	21	190	35	320000	221,35
M22	34	23	205	40	322000	312,59
M24	37	25	205	40	324000	384,62



Articolo Article	Imbocco Chamfer	Campo d'applicazione Application field	Tolleranza Tolerance	Materiale tipo Tool material	Superficie Surface	Standard	Gamma dal (M) diameter range (M)	pag page
MASCHI A MANO HAND TAPS								
Filettatura Metrica ISO passo grosso DIN 13 ISO Metric coarse thread DIN 13								
 M 500 (set 3 pezzi / 3 pcs set)		Acciai comuni Standard steel	6H	HSS	White	DIN 352	M 2 - M 52	116
 M 501 Sbozzatore /Rougher		Acciai comuni Standard steel		HSS	White	DIN 352	M 2 - M 52	116
 M 501 Semifinitore / semifinisher		Acciai comuni Standard steel		HSS	White	DIN 352	M 2 - M 52	116
 M 501 Finitore / Finisher		Acciai comuni Standard steel	6H	HSS	White	DIN 352	M 2 - M 52	116
 M 518 S / Left		Acciai comuni Standard steel	6H	HSS	White	DIN 352	M 3 - M 39	117
 M 519 S / Left		Acciai comuni Standard steel	6H	HSS	White	DIN 352	M 3 - M 39	117
 M 523		Acciai inox Stainless steel	6HX	HSS-E	White	DIN 352	M 3 - M 20	118
 M 523		Acciai inox Stainless steel	6HX	HSS-E	Quartz	DIN 352	M 3 - M 20	118
 M 595		Acciai durezza HRC 40 Hardness steel HRC 40	6HX	RESISTOR	Opal	DIN 352	M 3 - M 20	119





Articolo Article	Imbocco Chamfer	Campo d'applicazione Application field	Tolleranza Tolerance	Materiale tipo Tool material	Superficie Surface	Standard	Gamma dal (M) diameter range (M)	pag page
Filettatura Metrica ISO passo fine DIN 13 ISO Metric Fine thread DIN 13								
 MF 510 (set 2 pezzi / 2 pcs set)		Acciai comuni Standard steel	6H	HSS	White	DIN 2181	M 3 - M 52	120
 MF 596		Acciai durezza HRC 40 Hardness steel HRC 40	6HX	RESISTOR	Opal	DIN 2181	M 8 - M 16	122
Filettatura GAS cilindrica Whitworth DIN EN ISO 228 Whitworth pipe thread DIN EN ISO 228								
 G 540 set 2 pezzi / 2 pcs set		Acciai comuni Standard steel	ISO 228	HSS	White	DIN 5157	G 1/8-28 - G2-11	123
 G 555		Acciai inox Stainless steel	ISO 228	HSS - E	White	DIN 5157	G 1/8-28 - G1/2-14	124
 G 554		Acciai durezza HRC 40 Hardness steel HRC 40	ISO 228	RESISTOR	Opal	DIN 5157	G 1/8-28 - G1/2-14	124
Filettatura Americana UNC Passo Grosso ASME B1.1 UNC coarse thread ASME B 1.1								
 UNC 556 set 3 pezzi / 3 pcs set		Acciai comuni Standard steel	2B	HSS	White	DIN 352	UNC 5- 40 - UNC 1" 1/2-6	125
Maschi a Mano Filettatura Americana UNF Passo Fine ASME B1.1 UNF fine thread ASME B 1.1								
 UNF 558 set 2 pezzi / 2 pcs set		Acciai comuni Standard steel	2B	HSS	White	DIN 2181	UNF 5-44 - UNF 1" 1/2-12	126
MASCHI A MACCHINA MACHINE TAPS								
Filettatura Metrica ISO passo grosso DIN 13 ISO Metric coarse thread DIN 13								
 M 508 fori passanti		Acciai tenaci Hardened steel	6H	HSS - EX	Black White	DIN 371	M 2 - M 10	127
 M 508 fori passanti		Acciai tenaci Hardened steel	6H	HSS - EX	Quartz	DIN 371	M 2 - M 10	127
 M 508 fori passanti		Acciai tenaci Hardened steel	6H	HSS - EX	Titanite	DIN 371	M 2 - M 10	127
 M 508 fori passanti		Acciai tenaci Hardened steel	6H	RESISTOR	Opal	DIN 371	M 2 - M 10	127
 M 502 fori passanti		Acciai tenaci Hardened steel	6H	HSS - EX	Black White	DIN 376	M 3- M 42	128



























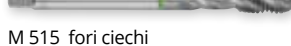

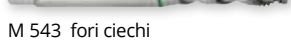





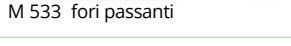

Articolo Article	Imbocco Chamfer	Campo d'applicazione Application field	Tolleranza Tolerance	Materiale tipo Tool material	Superficie Surface	Standard	Gamma dal (M) diameter range (M)	pag page
 M 502 fori passanti		Acciai tenaci Hardened steel	6H	HSS - EX	Quartz	DIN 376	M 3 - M 42	128
 M 502 fori passanti		Acciai tenaci Hardened steel	6H	HSS - EX	Titanite	DIN 376	M 3 - M 42	128
 M 503 fori ciechi		Acciai tenaci Hardened steel	6H	HSS - EX	Black White	DIN 376	M 3 - M 52	129
 M 503 fori ciechi		Acciai tenaci Hardened steel	6H	HSS - EX	Quartz	DIN 376	M 3 - M 52	129
 M 503 fori ciechi		Acciai tenaci Hardened steel	6H	HSS - EX	Titanite	DIN 376	M 3 - M 52	129
 M 521S fori ciechi		Acciai tenaci Hardened steel	6H	HSS - EX	Black White	DIN 376	M 3 - M 39	129
 M 509 fori ciechi		Acciai tenaci Hardened steel	6H	HSS - EX	Black White	DIN 371	M 2 - M 10	130
 M 509 fori ciechi		Acciai tenaci Hardened steel	6H	HSS - EX	Quartz	DIN 371	M 2 - M 10	130
 M 509 fori ciechi		Acciai tenaci Hardened steel	6H	HSS - EX	Titanite	DIN 371	M 2 - M 10	130
 M 514 dadi		Acciai comuni Standard steel	6H	HSS - EX	Black White	DIN 357	M 4 - M 20	131
 M 514 dadi		Acciai comuni Standard steel	6H	HSS - EX	Quartz	DIN 357	M 4 - M 20	131
 M 514 dadi		Acciai comuni Standard steel	6H	HSS - EX	Titanite	DIN 357	M 4 - M 20	131
 M 511 fori ciechi		Acciai tenaci Hardened steel	6H	HSS - EX	Black White	DIN 371	M 2 - M 10	132
 M 511 fori ciechi		Acciai tenaci Hardened steel	6H	HSS - EX	Quartz	DIN 371	M 2 - M 10	132
 M 511 fori ciechi		Acciai tenaci Hardened steel	6H	HSS - EX	Titanite	DIN 371	M 2 - M 10	132
 M 505 fori ciechi		Acciai tenaci Hardened steel	6H	HSS - EX	Black White	DIN 376	M 3 - M 36	133
 M 505 fori ciechi		Acciai tenaci Hardened steel	6H	HSS - EX	Quartz	DIN 376	M 3 - M 36	133
 M 505 fori ciechi		Acciai tenaci Hardened steel	6H	HSS - EX	Titanite	DIN 376	M 3 - M 36	133
 M 512 fori ciechi		Acciai tenaci Hardened steel	6H	HSS - EX	Black White	DIN 371	M 2 - M 10	134
 M 512 fori ciechi		Acciai tenaci Hardened steel	6H	HSS - EX	Quartz	DIN 371	M 2 - M 10	134

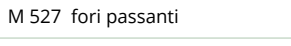





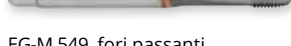







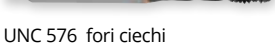
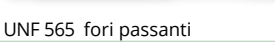

Articolo Article	Imbocco Chamfer	Campo d'applicazione Application field	Tolleranza Tolerance	Materiale tipo Tool material	Superficie Surface	Standard	Gamma dal (M) diameter range (M)	pag page
 M 512 fori ciechi		Acciai tenaci Hardened steel	6H	HSS - EX	Titanite	DIN 371	M 2 - M 10	134
 M 512 fori ciechi		Acciai tenaci Hardened steel	6H	RESISTOR	Opal	DIN 371	M 2 - M 10	134
 M 506 fori ciechi		Acciai tenaci Hardened steel	6H	HSS - EX	Black White	DIN 376	M 3 - M 36	135
 M 506 fori ciechi		Acciai tenaci Hardened steel	6H	HSS - EX	Quartz	DIN 376	M 3 - M 36	135
 M 506 fori ciechi		Acciai tenaci Hardened steel	6H	HSS - EX	Titanite	DIN 376	M 3 - M 36	135
Filettatura Metrica ISO passo fine DIN 13 ISO Metric fine thread DIN 13								
 MF 520 fori passanti		Acciai tenaci Hardened steel	6H	HSS - EX	Black White	DIN 374	MF 4 - MF 36	136
 MF 520 fori passanti		Acciai tenaci Hardened steel	6H	HSS - EX	Quartz	DIN 374	MF 4 - MF 36	136
 MF 520 fori passanti		Acciai tenaci Hardened steel	6H	HSS - EX	Titanite	DIN 374	MF 4 - MF 36	136
 MF 530 fori ciechi		Acciai tenaci Hardened steel	6H	HSS - EX	Black White	DIN 374	MF 4 - MF24	137
 MF 530 fori ciechi		Acciai tenaci Hardened steel	6H	HSS - EX	Quartz	DIN 374	MF 4 - MF24	137
 MF 530 fori ciechi		Acciai tenaci Hardened steel	6H	HSS - EX	Titanite	DIN 374	MF 4 - MF24	137
 MF 522S fori ciechi		Acciai tenaci Hardened steel	6H	HSS - EX	Black White	DIN 374	MF 4 - MF24	137
 MF 507 fori ciechi		Acciai tenaci Hardened steel	6H	HSS - EX	Black White	DIN 374	MF 4 - MF 36	138
 MF 507 fori ciechi		Acciai tenaci Hardened steel	6H	HSS - EX	Quartz	DIN 374	MF 4 - MF 36	138
 MF 507 fori ciechi		Acciai tenaci Hardened steel	6H	HSS - EX	Titanite	DIN 374	MF 4 - MF 36	138
Filettatura GAS cilindrica Whitworth DIN EN ISO 228 Whitworth pipe thread DIN EN ISO 228								
 G 550 fori passanti		Acciai tenaci Hardened steel	ISO 228	HSS - EX	Black White	DIN 5156	G 1/8 - 28 - G 2" -11	139
 G 550 fori passanti		Acciai tenaci Hardened steel	ISO 228	HSS - EX	Quartz	DIN 5156	G 1/8 - 28 - G 2" -11	139
 G 550 fori passanti		Acciai tenaci Hardened steel	ISO 228	HSS - EX	Titanite	DIN 5156	G 1/8 - 28 - G 2" -11	139



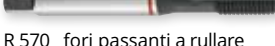
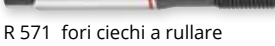
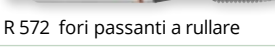





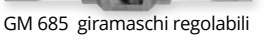





Articolo Article	Imbocco Chamfer	Campo d'applicazione Application field	Tolleranza Tolerance	Materiale tipo Tool material	Superficie Surface	Standard	Gamma dal (M) diameter range (M)	pag page
 G 504 fori ciechi		Acciai tenaci Hardened steel	ISO 228	HSS - EX	Black White	DIN 5156	G 1/8 - 28 - G 2" -11	140
 G 504 fori ciechi		Acciai tenaci Hardened steel	ISO 228	HSS - EX	Quartz	DIN 5156	G 1/8 - 28 - G 2" -11	140
 G 504 fori ciechi		Acciai tenaci Hardened steel	ISO 228	HSS - EX	Titanite	DIN 5156	G 1/8 - 28 - G 2" -11	140
 G 551 fori ciechi		Acciai tenaci Hardened steel	ISO 228	HSS - EX	Black White	DIN 5156	G 1/8 - 28 - G 1" -11	141
 G 551 fori ciechi		Acciai tenaci Hardened steel	ISO 228	HSS - EX	Quartz	DIN 5156	G 1/8 - 28 - G 1" -11	141
 G 551 fori ciechi		Acciai tenaci Hardened steel	ISO 228	HSS - EX	Titanite	DIN 5156	G 1/8 - 28 - G 1" -11	141
Filettatura Americana UNC Passo Grosso ASME B1.1 UNC coarse thread ASME B 1.1								
 UNC 560 fori passanti		Acciai tenaci Hardened steel	2B	HSS - EX	Black White	DIN 371 DIN 376	UNC 5-40 - UNC 1"1/2 -16	142
 UNC 560 fori passanti		Acciai tenaci Hardened steel	2B	HSS - EX	Quartz	DIN 371 DIN 376	UNC 5-40 - UNC 1"1/2 -16	142
 UNC 560 fori passanti		Acciai tenaci Hardened steel	2B	HSS - EX	Titanite	DIN 371 DIN 376	UNC 5-40 - UNC 1"1/2 -16	142
 UNC 561 fori ciechi		Acciai tenaci Hardened steel	2B	HSS - EX	Black White	DIN 371 DIN 376	UNC 5 - 40 - UNC 1"1/2 -16	143
 UNC 561 fori ciechi		Acciai tenaci Hardened steel	2B	HSS - EX	Quartz	DIN 371 DIN 376	UNC 5 - 40 - UNC 1"1/2 -16	143
 UNC 561 fori ciechi		Acciai tenaci Hardened steel	2B	HSS - EX	Titanite	DIN 371 DIN 376	UNC 5 - 40 - UNC 1"1/2 -16	143
 UNC 559 fori ciechi		Acciai tenaci Hardened steel	2B	HSS - E	Black White	DIN 371 DIN 376	UNC 5-40 - UNC 1"1/2 -16	144
 UNC 559 fori ciechi		Acciai tenaci Hardened steel	2B	HSS - E	Quartz	DIN 371 DIN 376	UNC 5-40 - UNC 1"1/2 -16	144
 UNC 559 fori ciechi		Acciai tenaci Hardened steel	2B	HSS - E	Titanite	DIN 371 DIN 376	UNC 5-40 - UNC 1"1/2 -16	144
Filettatura Americana UNF Passo Fine ASME B1.1 UNF fine thread ASME B 1.1								
 UNF 562 fori passanti		Acciai tenaci Hardened steel	2B	HSS - EX	Black White	DIN 371 DIN 374	UNF 5-44 - UNF 1"-12	145
 UNF 562 fori passanti		Acciai tenaci Hardened steel	2B	HSS - EX	Quartz	DIN 371 DIN 374	UNF 5-44 - UNF 1"-12	145
 UNF 562 fori passanti		Acciai tenaci Hardened steel	2B	HSS - EX	Titanite	DIN 371 DIN 374	UNF 5-44 - UNF 1"-12	145
 UNF 563 fori ciechi		Acciai tenaci Hardened steel	2B	HSS - EX	Black White	DIN 371 DIN 374	UNF 5-44 - UNF 1"1/2 -12	146

Articolo Article	Imbocco Chamfer	Campo d'applicazione Application field	Tolleranza Tolerance	Materiale tipo Tool material	Superficie Surface	Standard	Gamma dal (M) diameter range (M)	pag page
 UNF 563 fori ciechi		Acciai tenaci Hardened steel	2B	HSS - EX	Quartz	DIN 371 DIN 374	UNF 5-44 - UNF 1"1/2 -12	146
 UNF 563 fori ciechi		Acciai tenaci Hardened steel	2B	HSS - EX	Titanite	DIN 371 DIN 374	UNF 5-44 - UNF 1"1/2 -12	146
 UNF 564 fori ciechi		Acciai tenaci Hardened steel	2B	HSS - E	Black White	DIN 371 DIN 374	UNF 5-44 - UNF 1"1/2 -12	147
 UNF 564 fori ciechi		Acciai tenaci Hardened steel	2B	HSS - E	Quartz	DIN 371 DIN 374	UNF 5-44 - UNF 1"1/2 -12	147
 UNF 564 fori ciechi		Acciai tenaci Hardened steel	2B	HSS - E	Titanite	DIN 371 DIN 374	UNF 5-44 - UNF 1"1/2 -12	147
Filettatura Whitworth a passo grosso norma BS 84 Whitworth thread standard BS 84								
 W 580 fori passanti		Acciai tenaci Hardened steel	Medium	HSS - EX	Black White	DIN 371 DIN 376	W 1/8 - 40 - W 1 - 8	148
 W 581 fori ciechi		Acciai tenaci Hardened steel	Medium	HSS - EX	Black White	DIN 371 DIN 376	W 1/8 - 40 - W 1 - 8	149
Filettatura Gas Conica Americana, conicità 1:16 ANSI/ASME B 1.20.1 American Tapered pipe thread, taper 1:16 ANSI/ASME B 1.20.1								
 NPT 590 fori ciechi		Acciai tenaci Hardened steel		HSS - EX	Black White	DIN 371 DIN 374	NPT 1/8-27 - NPT 1"-11.1/2	150
Filettatura Metrica ISO passo grosso DIN 13 ISO Metric coarse thread DIN 13								
 M 531 fori passanti		Acciai tenaci Hardened steel	6G	HSS - E	Black White	DIN 371 DIN 376	M 3 - M 20	151
 M 532 fori ciechi		Acciai tenaci Hardened steel	6G	HSS - E	Black White	DIN 371 DIN 376	M 3 - M 20	152
 M 546 fori passanti		Acciai tenaci Hardened steel	6H	HSS - E	Black White	DIN 371EL DIN 376EL	M 3 - M 16	153
 M 546 fori passanti		Acciai tenaci Hardened steel	6H	HSS - E	Quartz	DIN 371EL DIN 376EL	M 3 - M 16	153
 M 546 fori passanti		Acciai tenaci Hardened steel	6H	HSS - E	Titanite	DIN 371EL DIN 376EL	M 3 - M 16	153
 M 545 fori ciechi		Acciai tenaci Hardened steel	6H	HSS - E	Black White	DIN 371EL DIN 376EL	M 3 - M 16	154
 M 545 fori ciechi		Acciai tenaci Hardened steel	6H	HSS - E	Quartz	DIN 371EL DIN 376EL	M 3 - M 16	154
 M 545 fori ciechi		Acciai tenaci Hardened steel	6H	HSS - E	Titanite	DIN 371EL DIN 376EL	M 3 - M 16	154
Filettatura per tubi corazzati DIN 40430 Steel conduit thread DIN 40430								
 PG 591 fori ciechi		Acciai comuni Standard steel		HSS - E	White	DIN 40432	PG 7 - 20 - PG 29 - 16	155

Articolo Article	Imbocco Chamfer	Campo d'applicazione Application field	Tolleranza Tolerance	Materiale tipo Tool material	Superficie Surface	Standard	Gamma dal (M) diameter range (M)	pag page
Filettatura Metrica ISO passo grosso DIN 13 ISO Metric coarse thread DIN 13								
 PM 700 punta a forare kombi		Acciai comuni Standard steel	6H	HSS	White	CARMON NORM.	M 3 - M 12	156
 PM 700 punta a forare kombi		Acciai comuni Standard steel	6H	HSS	Quartz	CARMON NORM.	M 3 - M 12	156
 M 535 fori passanti		Acciai comuni Standard steel	6H	HSS - EX	Black White	DIN 371 DIN 376	M 3 - M 30	157
 M 535 fori passanti		Acciai comuni Standard steel	6H	HSS - EX	Quartz	DIN 371 DIN 376	M 3 - M 30	157
 M 536 fori ciechi		Acciai comuni Standard steel	6H	HSS - EX	Black White	DIN 371 DIN 376	M 3 - M 30	157
 M 536 fori ciechi		Acciai comuni Standard steel	6H	HSS - EX	Quartz	DIN 371 DIN 376	M 3 - M 30	157
 M 516 fori passanti		Acciai inox Stainless steel	6H	HSS - EX	Black White	DIN 371 DIN 376	M 2 - M 30	158
 M 516 fori passanti		Acciai inox Stainless steel	6H	HSS - EX	Quartz	DIN 371 DIN 376	M 2 - M 30	158
 M 517 fori ciechi		Acciai inox Stainless steel	6H	HSS - EX	Black White	DIN 371 DIN 376	M 2 - M 30	158
 M 517 fori ciechi		Acciai inox Stainless steel	6H	HSS - EX	Quartz	DIN 371 DIN 376	M 2 - M 30	158
Filettatura Metrica ISO passo fine DIN 13 ISO Metric fine thread DIN 13								
 MF 547 fori passanti		Acciai inox Stainless steel	6H	HSS - E	Black White	DIN 371 DIN 374	MF 4 - M 16	159
 MF 547 fori passanti		Acciai inox Stainless steel	6H	HSS - E	Quartz	DIN 371 DIN 374	MF 4 - M 16	159
 MF 548 fori ciechi		Acciai inox Stainless steel	6H	HSS - E	Black White	DIN 371 DIN 374	MF 4 - M 16	160
 MF 548 fori ciechi		Acciai inox Stainless steel	6H	HSS - E	Quartz	DIN 371 DIN 374	MF 4 - M 16	160
Filettatura GAS cilindrica Whitworth DIN EN ISO 228 Whitworth pipe thread GAS DIN EN ISO 228								
 G 553 fori passanti		Acciai inox Stainless steel		HSS - E	Black White	DIN 5156	G 1/8 - 28 - G 1" -11	161
 G 553 fori passanti		Acciai inox Stainless steel		HSS - E	Quartz	DIN 5156	G 1/8 - 28 - G 1" -11	161
 G 552 fori ciechi		Acciai inox Stainless steel		HSS - E	Black White	DIN 5156	G 1/8 - 28 - G 1" -11	162
 G 552 fori ciechi		Acciai inox Stainless steel		HSS - E	Quartz	DIN 5156	G 1/8 - 28 - G 1" -11	162

Articolo Article	Imbocco Chamfer	Campo d'applicazione Application field	Tolleranza Tolerance	Materiale tipo Tool material	Superficie Surface	Standard	Gamma dal (M) diameter range (M)	pag page
Filettatura Metrica ISO passo grosso DIN 13 ISO Metric coarse thread DIN 13								
 M 513 fori passanti		Alluminio - Rame Aluminium - Copper	6H	HSS - EX	Black White	DIN 371	M 3 - M 10	163
 M 513 fori passanti		Alluminio - Rame Aluminium - Copper	6H	HSS - EX	Quartz	DIN 371	M 3 - M 10	163
 M 513 fori passanti		Alluminio - Rame Aluminium - Copper	6H	HSS - EX	Titanite	DIN 371	M 3 - M 10	163
 M 544 fori passanti		Alluminio aluminium	6H	HSS - E	White	DIN 371 DIN 376	M 3 - M 12	164
 M 541 fori ciechi		Alluminio aluminium	6HX	HSS - E	Titanite	DIN 371 DIN 376	M 3 - M 16	165
 M 542 fori ciechi		Alluminio aluminium	6HX	RESISTOR	Opal	DIN 371 DIN 376	M 5 - M 16	166
 M 515 fori ciechi		Alluminio - Rame Aluminium - Copper	6H	HSS - EX	Black White	DIN 376	M 3 - M 16	167
 M 515 fori ciechi		Alluminio - Rame Aluminium - Copper	6H	HSS - EX	Quartz	DIN 376	M 3 - M 16	167
 M 515 fori ciechi		Alluminio - Rame Aluminium - Copper	6H	HSS - EX	Titanite	DIN 376	M 3 - M 16	167
 M 543 fori ciechi		Alluminio aluminium	6H	HSS - E	White	DIN 371 DIN 376	M 3 - M 12	168
 M 524 fori ciechi		Ghisa cast iron	6HX	RESISTOR	Opal	DIN 371 DIN 376	M 3 - M 16	169
 M 525 fori ciechi		Ghisa Cast Iron	6HX	RESISTOR	Opal	DIN 371 DIN 376	M 5 - M 16	170
 M 526 fori ciechi		Ghisa Cast Iron	6HX	RESISTOR	Opal	DIN 371 DIN 376	M 5 - M 16	171
 M 533 fori passanti		Acciai tenaci Hardened steel	6H	RESISTOR	Opal	DIN 371 DIN 376	M 3 - M 16	172
 M 527 fori passanti		Acciai tenaci Hardened steel	6H	RESISTOR	Opal	DIN 371 DIN 376	M 5 - M 16	173
 M 534 fori ciechi		Acciai tenaci Hardened steel	6H	RESISTOR	Opal	DIN 371 DIN 376	M 3 - M 16	174
 M 528 fori ciechi		Acciai tenaci Hardened steel	6H	RESISTOR	Opal	DIN 371 DIN 376	M 5 - M 16	175
 EG-M 549 fori passanti		Acciai tenaci Hardened steel	6H	RESISTOR	Opal	DIN 371 DIN 376	EG - M 2 EG - M 20	176

Articolo Article	Imbocco Chamfer	Campo d'applicazione Application field	Tolleranza Tolerance	Materiale tipo Tool material	Superficie Surface	Standard	Gamma dal (M) diameter range (M)	pag page
 EG-M529 fori ciechi		Acciai tenaci Hardened steel	6H	RESISTOR	Opal	DIN 371 DIN 376	EG - M 2 EG - M 20	177
 G 537 fori passanti		Acciai tenaci Hardened steel	ISO 228	RESISTOR	Opal	DIN 5156	G 1/8 G 1"	178
 G 538 fori ciechi		Acciai tenaci Hardened steel	ISO 228	RESISTOR	Opal	DIN 5156	G 1/8 G 1"	178
 UNC 575 fori passanti		Acciai tenaci Hardened steel	2B	RESISTOR	Opal	DIN 371 DIN 376	UNC 4-40 UNC 5/8-11	179
 UNC 576 fori ciechi		Acciai tenaci Hardened steel	2B	RESISTOR	Opal	DIN 371 DIN 376	UNC 4-40 UNC 5/8-11	180
 UNF 565 fori passanti		Acciai tenaci Hardened steel	2B	RESISTOR	Opal	DIN 371 DIN 376	UNC 4-48 UNC 5/8-18	181
 UNF 567 fori ciechi		Acciai tenaci Hardened steel	2B	RESISTOR	Opal	DIN 371 DIN 376	UNC 4-48 UNC 5/8-18	182
 M 539 HM fori ciechi		Acciaio HRC 40/60 Hardness steel HRC 40/60	6HX	HM	Opal	DIN 371 DIN 376	M 3 - M 16	183
 CL 28 M HM		Acciai tenaci Hardened steel		MICROGRAIN CARBIDE Co10	Sapphire	CARMON NORM.	M6 - M16	184
Filettatura Metrica ISO passo fine DIN 13 ISO Metric fine thread DIN 13								
 CL 29 MF HM		Acciai tenaci Hardened steel		MICROGRAIN CARBIDE Co10	Sapphire	CARMON NORM.	M8 - M20	185
Punte per rimuovere maschi rotti Drills to remove broken Taps								
 P HM 701				HM	Titanite		M 3 - M 12	186
Filettatura Metrica ISO passo grosso DIN 13 ISO Metric coarse thread DIN 13								
 R 570 fori passanti a rullare		Acciai tenaci Hardened steel	6HX	HSS - EX	Black White	DIN 371	M 3 - M 10	187
 R 571 fori ciechi a rullare		Acciai tenaci Hardened steel	6HX	HSS - EX	Black White	DIN 371	M 3 - M 10	187
 R 572 fori passanti a rullare		Acciai tenaci Hardened steel	6HX	HSS - EX	Black White	DIN 371	M 2 - M 10	187
 R 573 fori ciechi		Acciai tenaci Hardened steel	6HX	RESISTOR	Quartz	DIN 371	M 4 - M 10	188
 R 574 fori ciechi		Acciai tenaci Hardox Hardened Steel Hardox	6HX	RESISTOR	Opal	DIN 371	M 5 - M 10	189
Giramaschi regolabili Adjustable tap wrenches								
 GM 685 giramaschi regolabili				HSS	White	DIN 1814	0 - 7	190

Articolo Article	Imbocco Chamfer	Campo d'applicazione Application field	Tolleranza Tolerance	Materiale tipo Tool material	Superficie Surface	Standard	Gamma dal (M) diameter range (M)	pag page
FILIERE DIES								
Filettatura Metrica ISO passo grosso DIN 13 ISO Metric coarse thread DIN 13								
 FM 610	IMBOCCO CORRETTO SPIRAL POINT	Acciai comuni Standard steel	6g	HSS	White	DIN EN 22568	M 1,6 - M52	191
 FMX 670	IMBOCCO CORRETTO SPIRAL POINT	Acciai inox Stainless steel	6g	HSS-E	Black	DIN EN 22568	M 3 - M30	191
 FMS 630	IMBOCCO CORRETTO SPIRAL POINT	Acciai comuni Standard steel	6g	HSS	White	DIN EN 22568	M 3 - M30	191
Filettatura Metrica ISO passo fine DIN 13 ISO Metric fine thread thread DIN 13								
 FMF 600	IMBOCCO CORRETTO SPIRAL POINT	Acciai comuni Standard steel	6g	HSS	White	DIN EN 22568	MF 2 - MF 52	192
 FMFX 680	IMBOCCO CORRETTO SPIRAL POINT	Acciai inox Stainless steel	6g	HSS-E	Black	DIN EN 22568	MF 8 - MF 24	192
 FMFS 640	IMBOCCO CORRETTO SPIRAL POINT	Acciai comuni Standard steel	6g	HSS	White	DIN EN 22568	MF 3 - MF 30	192
Filettatura Americana UNC Passo Grosso ASME B1.1 UNC coarse thread ASME B 1.1								
 FUNC 645	IMBOCCO CORRETTO SPIRAL POINT	Acciai comuni Standard steel	2A	HSS	White	DIN EN 22568	UNC 4-40 / UNC 1"-8	195
Filettatura Americana UNF Passo fine ASME B1.1 UNF fine thread ASME B 1.1								
 FUNF 650	IMBOCCO CORRETTO SPIRAL POINT	Acciai comuni Standard steel	2A	HSS	White	DIN EN 22568	UNF 4-48 / UNF 1"-12	196
Filettatura GAS cilindrica Whitworth DIN EN ISO 228 Whitworth pipe thread DIN EN ISO 228								
 FG 620	IMBOCCO CORRETTO SPIRAL POINT	Acciai comuni Standard steel	A	HSS	White	DIN EN 24231	G 1/8 - 28 - G 2" -11	197
 FGX 622	IMBOCCO CORRETTO SPIRAL POINT	Acciai inox Stainless steel	A	HSS-E	Black	DIN EN 24231	G 1/8 - 28 - G 1" -11	197
Filettatura Whitworth a passo grosso norma BS 84 Whitworth thread standard BS 84								
 FW 660	IMBOCCO CORRETTO SPIRAL POINT	Acciai comuni Standard steel	Medium	HSS	White	DIN EN 22568	W 1/16" -60 - W 1 1/2" - 6	198
Filettatura GAS conica Americana, conicità 1:16 American tapered pipe threads, taper 1:16								
 FNPT 690	IMBOCCO CORRETTO SPIRAL POINT	Acciai comuni Standard steel		HSS	White	DIN EN 22568	NPT 1/8-27 - NPT 1"-11.1/2	199
Filettatura per tubi corazzati DIN 40430 Steel conduit thread DIN 40430								
 FPG 691	IMBOCCO CORRETTO SPIRAL POINT	Acciaio Standard Standard Steel		HSS	White	DIN EN 22568	PG 7 - 20 - PG 29 - 16	200
Porta filiere Die stocks								
 PF 856	PORTA FILIERE				White	DIN 225	0 -14	201

MASCHI A MANO HAND TAPS				MASCHI A MACCHINA MACHINE TAPS											
G555	G554	UNC556	UNC558	M508				M502			M503			M521S	
DIN 5157		DIN 352	DIN 2181	DIN 371				DIN 376							
				○				○			○			○	
HSS-E	RES	HSS		HSS-EX				HSS-EX			HSS-EX				
mt/min	mt/min	mt/min	mt/min	mt/min	mt/min	mt/min	mt/min	mt/min	mt/min	mt/min	mt/min	mt/min	mt/min	mt/min	
	√														
				26	41	50	60	26	41	50	26	41	50	26	
				23	38	47	57	23	38	47	23	38	47	23	
				10	13	17	27	10	13	17	10	13	17	10	
√															
√															
√															
				16	26	30	40	16	26	30	16	26	30	16	
				5	10	19	30	5	10	19	5	10	19	5	
				13	27	30	40	13	27	30	13	27	30	13	
				6	10	13	27	6	10	13	6	10	13	6	



rpm
 $= (\text{mt/min} \times 1000) / (D \times 3,14)$



= mt/min

















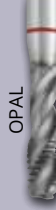



















✓ consigliato / recommended

MASCHI A MACCHINA MACHINE TAPS



Pag. 378	TIPO DI ACCIAIO TYPE OF STEEL	N/mm ²	HV	C			~12P			C			
				mt/min	mt/min	mt/min	mt/min	mt/min	mt/min	mt/min	mt/min	mt/min	
	HRC 40												
	HRC 60												
	HARDOX												
ACCIAI COMUNI COMMON STEEL	Acciai teneri Soft steel	1	500	160	26	41	50	26	41	48	26	41	50
	Acciai da costruzione Structural steel	2	700	220	23	38	47	23	38	43	23	38	47
	Acciai da tempra Hardening steel	3	900	280	10	13	17	10	13	15	10	13	17
	Acciaio automatico Automatic steel	4	1200	373									
ACCIAI INOX STAINLESS STEEL	Acciaio automatico Automatic steel	3	850	268				10	14	18			
	Austenitico Austenitic	3	850	268				8	12	15			
	Ferritico+austenitico Ferritic austenitic	4	1000	317									
GHISA CAST IRON	Ghisa fino a 180 hb Cast iron up to 180hb	2	500	160									
	Ghisa oltre 180 hb Cast iron over 180hb	3	700	220									
TITANIO TITANIUM	Titanio non legato Unalloyed titanium	5	500	160	16	26	30	16	26	30	16	26	30
	Leghe di titanio Titanium alloys	5	900	280	5	10	19	5	10	18	5	10	19
RAME COPPER	Rame Copper	9	350	110									
	Ottone Brass	9	700	220									
	Bronzo Bronze	9	700	220									
NICHEL NICKEL	Nichel non legato Unalloyed nichel	6	700	220	13	27	30				13	27	30
	Leghe di nichel Nichel alloys	6	900	280	6	10	13				6	10	13
ALLUMINIO ALUMINIUM	Alluminio non legato Unalloyed aluminium	7	350	110									
	Alluminio con leghe Alloyed aluminium	7	400	125									
	Alluminio con leghe Alloyed aluminium	7	500	160									

MASCHI A MACCHINA MACHINE TAPS

M505			M 512				M506			MF 520			MF 530		
															
DIN 376			DIN 371				DIN 376			DIN 374			DIN 374		
															
HSS-EX			HSS-EX				HSS-EX			HSS-EX			HSS-EX		
															
C										B			C		
mt/min	mt/min	mt/min	mt/min	mt/min	mt/min	mt/min	mt/min	mt/min	mt/min	mt/min	mt/min	mt/min	mt/min	mt/min	mt/min
26	41	50	26	41	50	60	26	41	50	26	41	50	26	41	50
23	38	47	23	38	47	57	23	38	47	23	38	47	23	38	47
10	13	17	10	13	17	27	10	13	17	10	13	17	10	13	17
						27									
						27									
16	26	30	16	26	30	40	16	26	30	16	26	30	16	26	30
5	10	19	5	10	19	30	5	10	19	5	10	19	5	10	19
13	27	30	13	27	30	40	13	27	30	13	27	30	13	27	30
6	10	13	6	10	13	27	6	10	13	6	10	13	6	10	13



rpm
 $= (\text{mt/min} \times 1000) / (D \times 3,14)$



= mt/min



consigliato / recommended

MASCHI A MACCHINA MACHINE TAPS

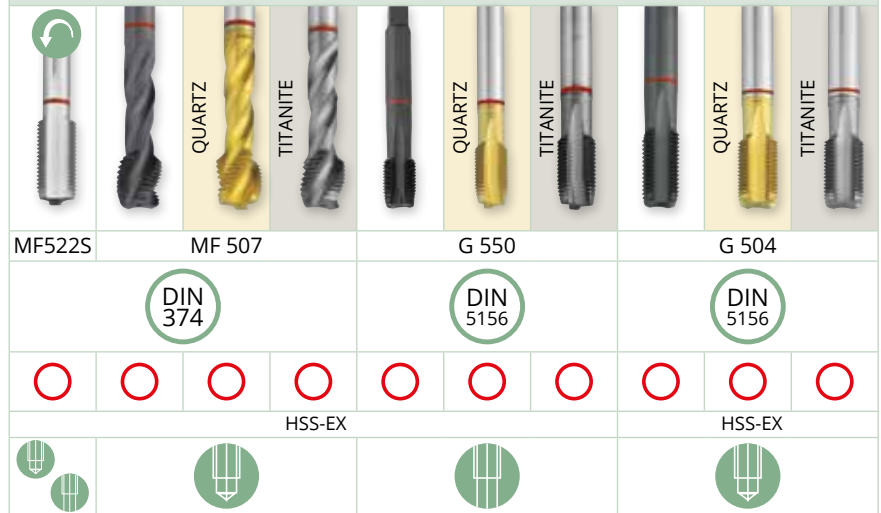









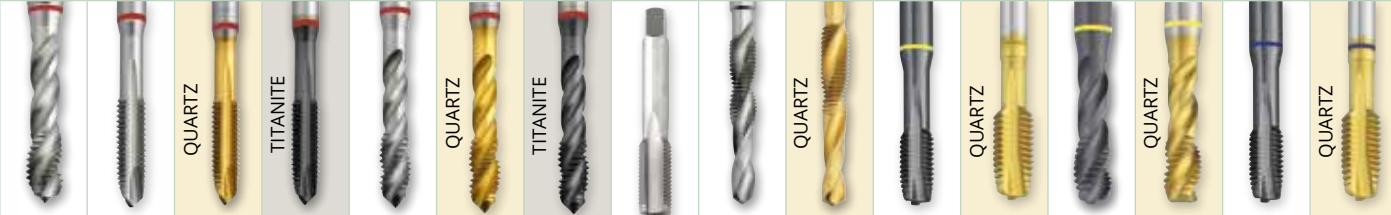



























Pag. 378	TIPO DI ACCIAIO TYPE OF STEEL	N/mm ²	HV	C			B			C				
				mt/min	mt/min	mt/min	mt/min	mt/min	mt/min	mt/min	mt/min	mt/min		
	HRC 40													
	HRC 60													
	HARDOX													
ACCIAI COMUNI COMMON STEEL	Acciai teneri Soft steel	1	500	160	26	26	41	50	26	41	50	26	41	50
	Acciai da costruzione Structural steel	2	700	220	23	23	38	47	23	38	47	23	38	47
	Acciai da tempra Hardening steel	3	900	280	10	10	13	17	10	13	17	10	13	17
	Acciaio automatico Automatic steel	4	1200	373										
ACCIAI INOX STAINLESS STEEL	Acciaio automatico Automatic steel	3	850	268										
	Austenitico Austenitic	3	850	268										
	Ferritico+austenitico Ferritic austenitic	4	1000	317										
GHISA CAST IRON	Ghisa fino a 180 hb Cast iron up to 180hb	2	500	160										
	Ghisa oltre 180 hb Cast iron over 180hb	3	700	220										
TITANIO TITANIUM	Titanio non legato Unalloyed titanium	5	500	160	16	16	26	30	16	26	30	16	26	30
	Leghe di titanio Titanium alloys	5	900	280	5	5	10	19	5	10	19	5	10	19
RAME COPPER	Rame Copper	9	350	110										
	Ottone Brass	9	700	220										
	Bronzo Bronze	9	700	220										
NICHEL NICKEL	Nichel non legato Unalloyed nichel	6	700	220	13	13	27	30	13	27	30	13	27	30
	Leghe di nichel Nichel alloys	6	900	280	6	6	10	13	6	10	13	6	10	13
ALLUMINIO ALUMINIUM	Alluminio non legato Unalloyed aluminium	7	350	110										
	Alluminio con leghe Alloyed aluminium	7	400	125										
	Alluminio con leghe Alloyed aluminium	7	500	160										

MASCHI A MACCHINA MACHINE TAPS

G551			UNC 560			UNC 561			UNC 559			UNF562					
	QUARTZ	TITANITE		QUARTZ	TITANITE		QUARTZ	TITANITE		QUARTZ	TITANITE		QUARTZ	TITANITE			
DIN 5156						DIN 371			DIN 376			DIN 371			DIN 374		
HSS-EX																	
mt/min	mt/min	mt/min	mt/min	mt/min	mt/min	mt/min	mt/min	mt/min	mt/min	mt/min	mt/min	mt/min	mt/min	mt/min			
26	41	50	26	41	50	26	41	50	26	41	50	26	41	50			
23	38	47	23	38	47	23	38	47	23	38	47	23	38	47			
10	13	17	10	13	17	10	13	17	10	13	17	10	13	17			
16	26	30	16	26	30	16	26	30	16	26	30	16	26	30			
5	10	19	5	10	19	5	10	19	5	10	19	5	10	19			
13	27	30	13	27	30	13	27	30	13	27	30	13	27	30			
6	10	13	6	10	13	6	10	13	6	10	13	6	10	13			

MASCHI A MACCHINA MACHINE TAPS

															
M 532	M546				M 545		PG 591	PM 700		M535		M 536		M516	
															
															
HSS-E	HSS-E						HSSE	HSS		HSS-EX					
															
															
mt/min	mt/min	mt/min	mt/min	mt/min	mt/min	mt/min	mt/min	mt/min	mt/min	mt/min	mt/min	mt/min	mt/min	mt/min	mt/min
26	26	41	50	26	41	50	26	26	40	26	41	26	41		
23	23	38	47	23	38	47	23	23	36	23	38	23	38		
10	10	13	17	10	13	17	10	10	12	10	13	10	13		
										10	14	10	14	10	14
										8	12	8	12	8	12
														5	10
16	15					15	16	16	24	16	26	16	26	16	26
5	5					5	5	5	10	5	10	5	10	5	10
13	10					10	13	13	25					13	27
6	5					5	6	6	10					6	10



rpm
 $= (\text{mt/min} \times 1000) / (D \times 3,14)$



= mt/min

✓ consigliato / recommended

MASCHI A MACCHINA MACHINE TAPS

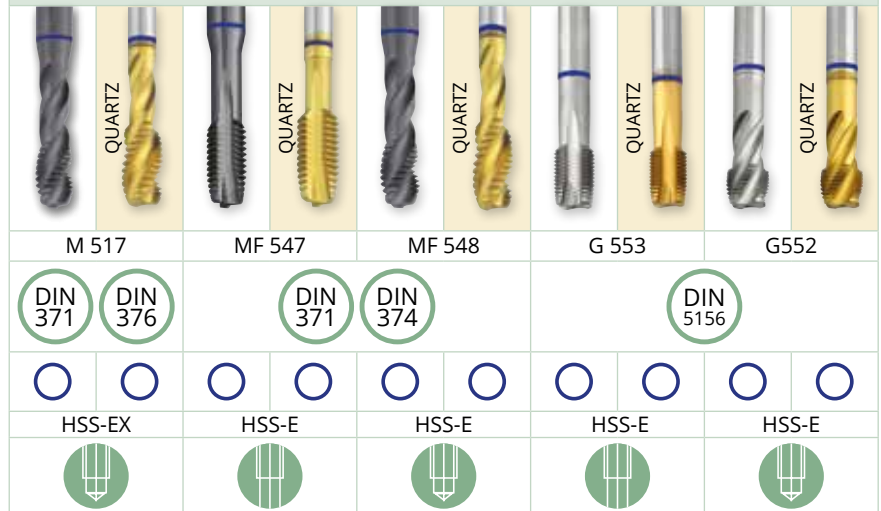

Pag. 378	TIPO DI ACCIAIO TYPE OF STEEL	N/mm ²	HV	C		B		C		B		C		
				mt/min	mt/min	mt/min	mt/min	mt/min	mt/min	mt/min	mt/min			
	HRC 40													
	HRC 60													
	HARDOX													
ACCIAI COMUNI COMMON STEEL	Acciai teneri Soft steel	1	500			26	41	26	41					
	Acciai da costruzione Structural steel	2	700			23	38	23	38					
	Acciai da tempratura Hardening steel	3	900			10	13	10	13					
	Acciaio automatico Automatic steel	4	1200											
ACCIAI INOX STAINLESS STEEL	Acciaio automatico Automatic steel	3	850	268	10	14	15	20	15	20	10	16	10	16
	Austenitico Austenitic	3	850	268	8	12	12	18	12	18	8	13	8	13
	Ferritico+austenitico Ferritic austenitic	4	1000	317	5	10	8	12	8	12	5	7	5	7
GHISA CAST IRON	Ghisa fino a 180 hb Cast iron up to 180hb	2	500	160										
	Ghisa oltre 180 hb Cast iron over 180hb	3	700	220										
TITANIO TITANIUM	Titanio non legato Unalloyed titanium	5	500	160	16	26	20	25	20	25	16		16	
	Leghe di titanio Titanium alloys	5	900	280	5	10	8	12	8	12	5		5	
RAME COPPER	Rame Copper	9	350	110										
	Ottone Brass	9	700	220										
	Bronzo Bronze	9	700	220										
NICHEL NICKEL	Nichel non legato Unalloyed nichel	6	700	220	13	27	15	20	15	20	13		13	
	Leghe di nichel Nichel alloys	6	900	280	6	10	8	12	8	12	6		6	
ALLUMINIO ALUMINIUM	Alluminio non legato Unalloyed aluminium	7	350	110										
	Alluminio con leghe Alloyed aluminium	7	400	125										
	Alluminio con leghe Alloyed aluminium	7	500	160										



rpm
 $= (\text{mt/min} \times 1000) / (D \times 3,14)$



= mt/min



consigliato / recommended

MASCHI A MACCHINA MACHINE TAPS

Pag. 378		TIPO DI ACCIAIO TYPE OF STEEL	N/mm ²	HV	RESISTOR									
					E	B	E	B	C	B	C	B	C	D
					mt/min	mt/min	mt/min	mt/min	mt/min	mt/min	mt/min	mt/min	mt/min	mt/min
		HRC 40												10
		HRC 60												5
		HARDOX			25	20	20	20	20	20	20	20	20	
ACCIAI COMUNI COMMON STEEL	Acciai teneri Soft steel	1	500	160	45	40	30	40	30	40	30	40	30	
	Acciai da costruzione Structural steel	2	700	220	35	28	20	28	20	28	20	28	20	
	Acciai da tempra Hardening steel	3	900	280	25	20	15	20	15	20	15	20	15	
	Acciaio automatico Automatic steel	4	1200	373										25
ACCIAI INOX STAINLESS STEEL	Acciaio automatico Automatic steel	3	850	268	22	18	15	18	15	18	15	18	15	
	Austenitico Austenitic	3	850	268	22	18	15	18	15	18	15	18	15	
	Ferritico+austenitico Ferritic austenitic	4	1000	317	22	18	15	18	15	18	15	18	15	
GHISA CAST IRON	Ghisa fino a 180 hb Cast iron up to 180hb	2	500	160										
	Ghisa oltre 180 hb Cast iron over 180hb	3	700	220										
TITANIO TITANIUM	Titanio non legato Unalloyed titanium	5	500	160	25	20	20	20	20	20	20	20	20	
	Leghe di titanio Titanium alloys	5	900	280	10	8	8	8	8	8	8	8	8	
RAME COPPER	Rame Copper	9	350	110	50	45	35	45	35	45	35	45	35	
	Ottone Brass	9	700	220	35	30	25	30	25	30	25	30	25	
	Bronzo Bronze	9	700	220	25	20	20	20	20	20	20	20	20	
NICHEL NICKEL	Nichel non legato Unalloyed nichel	6	700	220	28	22	22	22	22	22	22	22	22	
	Leghe di nichel Nichel alloys	6	900	280	10	8	8	8	8	8	8	8	8	
ALLUMINIO ALUMINIUM	Alluminio non legato Unalloyed aluminium	7	350	110			40		40		40		40	
	Alluminio con leghe Alloyed aluminium	7	400	125			60		60		60		60	
	Alluminio con leghe Alloyed aluminium	7	500	160			38		38		38		38	

MASCHI A MACCHINA MACHINE TAPS									FILIERE DIES				
													
CL28MHM	CL29MFHM	PHM 701	R 570	R 571	R 572	R 573	R 574	GM 685	FM 610	FMX 670	FMS 630	FMF 600	
													
													
HM			HSS-EX		RESISTOR				HSS	HSS-E	HSS	HSS	
													
													
mt/min	mt/min	mt/min	mt/min	mt/min	mt/min	mt/min	mt/min	mt/min	mt/min	mt/min	mt/min	mt/min	
80	80						30						
90	90		26	26	26	30	50		26	26	26	26	
80	80		23	23	23	25	35		23	23	23	23	
60	60		10	10	10	15	28		10	10	10	10	
40	40						20						
60	60						25		10	10	10	10	
60	60						25		8	8	8	8	
40	40						25		5	5	5	5	
120	120												
100	100												
50	50						28		16	16	16	16	
30	30						14		5	5	5	5	
150	150						60						
150	150						40						
160	160						28						
130	130						30		13	13	13	13	
100	100						18		6	6	6	6	
			17	17	17								
			36	36	36								
			16	16	16								



rpm
 $= (\text{mt/min} \times 1000) / (D \times 3,14)$



= mt/min







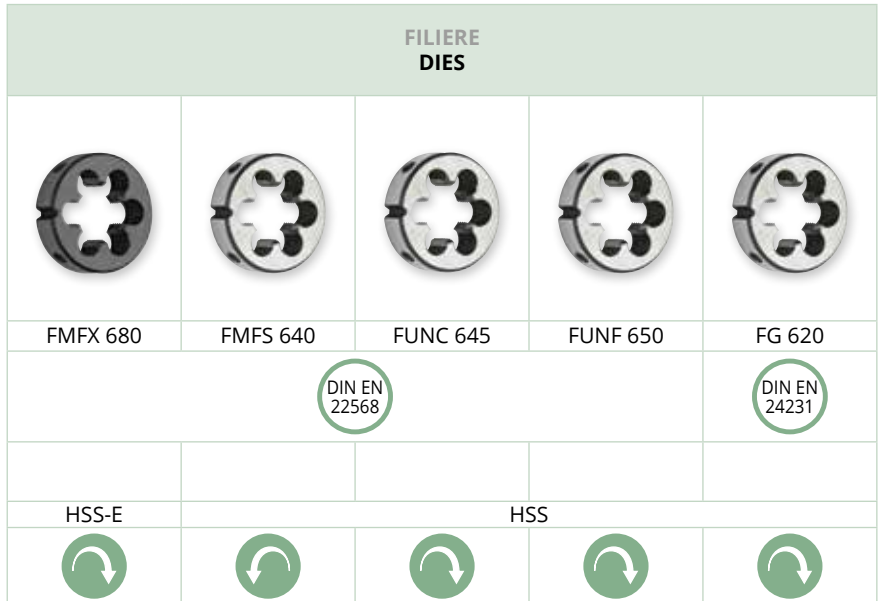









consigliato / recommended

Pag. 378	TIPO DI ACCIAIO TYPE OF STEEL	N/mm ²	HV	FILIERE DIES					
				FMFX 680	FMFS 640	FUNC 645	FUNF 650	FG 620	
	HRC 40								
	HRC 60								
	HARDOX								
ACCIAI COMUNI COMMON STEEL	Acciai teneri Soft steel	1	500	160	26	26	26	26	26
	Acciai da costruzione Structural steel	2	700	220	23	23	23	23	23
	Acciai da tempra Hardening steel	3	900	280	10	10	10	10	10
	Acciaio automatico Automatic steel	4	1200	373					
ACCIAI INOX STAINLESS STEEL	Acciaio automatico Automatic steel	3	850	268	10	10	10	10	10
	Austenitico Austenitic	3	850	268	8	8	8	8	8
	Ferritico+austenitico Ferritic austenitic	4	1000	317	5	5	5	5	5
GHISA CAST IRON	Ghisa fino a 180 hb Cast iron up to 180hb	2	500	160					
	Ghisa oltre 180 hb Cast iron over 180hb	3	700	220					
TITANIO TITANIUM	Titanio non legato Unalloyed titanium	5	500	160	16	16	16	16	16
	Leghe di titanio Titanium alloys	5	900	280	5	5	5	5	5
RAME COPPER	Rame Copper	9	350	110					
	Ottone Brass	9	700	220					
	Bronzo Bronze	9	700	220					
NICHEL NICKEL	Nichel non legato Unalloyed nichel	6	700	220	13	13	13	13	13
	Leghe di nichel Nichel alloys	6	900	280	6	6	6	6	6
ALLUMINIO ALUMINIUM	Alluminio non legato Unalloyed aluminium	7	350	110					
	Alluminio con leghe Alloyed aluminium	7	400	125					
	Alluminio con leghe Alloyed aluminium	7	500	160					



FILIERE DIES

				
FGX 622	FW 660	FNPT 690	FPG 691	PF856
				
HSS-E		HSS		
				
mt/min	mt/min	mt/min	mt/min	mt/min
26	26	26	26	
23	23	23	23	
10	10	10	10	
10	10	10	10	
8	8	8	8	
5	5	5	5	
16	16	16	16	
5	5	5	5	
13	13	13	13	
6	6	6	6	

M 500



M 501

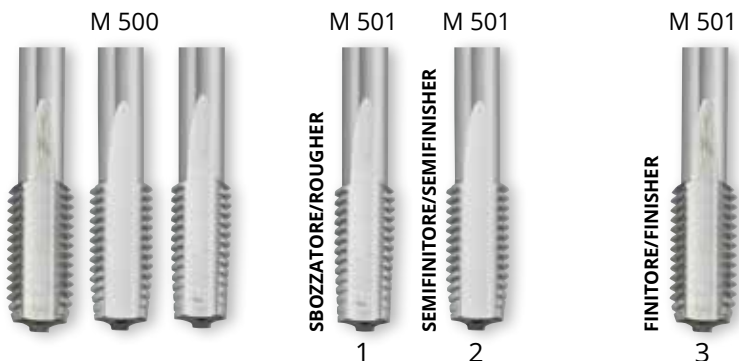
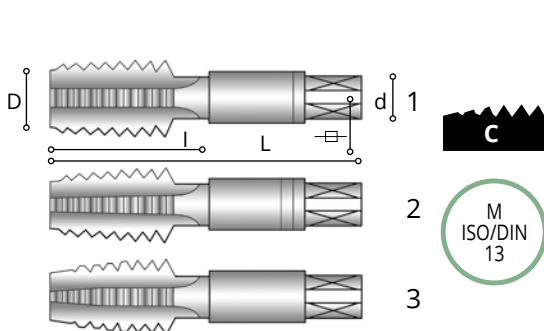

D		L	l	d		CODE	HSS				HSS	
							5500..... €	CODE	55011..... €	55012..... €	CODE	5501..... €
M 2 x 0,4	1,6	36	8	2,8	2,100002	35,170002	11,73	11,7300002	11,73
M 2,5 x 0,45	2	40	9	2,8	2,100025	31,160025	10,38	10,3800025	10,38
M 2,6 x 0,45	2,1	40	9	2,8	2,100026	31,160026	10,38	10,3800026	10,38
M 3 x 0,5	2,5	40	11	3,5	2,700003	24,480003	8,15	8,1500003	8,15
M 3,5 x 0,6	2,9	45	12	4	300035	27,790035	9,25	9,2500035	9,25
M 4 x 0,7	3,3	45	13	4,5	3,400004	24,480004	8,15	8,1500004	8,15
M 4,5 x 0,75	3,8	50	16	6	4,900045	40,370045	13,45	13,4500045	13,45
M 5 x 0,8	4,2	50	16	6	4,900005	26,120005	8,71	8,7100005	8,71
M 6 x 1	5	50	19	6	4,900006	26,120006	8,71	8,7100006	8,71
M 7 x 1	6	50	19	6	4,900007	38,150007	12,72	12,7200007	12,72
M 8 x 1,25	6,8	63	22	6	4,900008	29,420008	9,81	9,8100008	9,81
M 9 x 1,25	7,8	63	22	7	5,500009	49,880009	16,63	16,6300009	16,63
M 10 x 1,5	8,5	70	24	7	5,500100	37,290010	12,43	12,4300010	12,43
M 11 x 1,5	9,5	70	24	8	6,200110	56,810011	18,94	18,9400011	18,94
M 12 x 1,75	10,2	75	28	9	700120	47,520012	15,84	15,8400012	15,84
M 14 x 2	12	80	30	11	900140	59,940014	19,99	19,9900014	19,99
M 16 x 2	14	80	32	12	900160	73,480016	24,49	24,4900016	24,49
M 18 x 2,5	15,5	95	34	14	1100180	103,050018	34,35	34,3500018	34,35
M 20 x 2,5	17,5	95	34	16	1200200	113,450020	37,82	37,8200020	37,82
M 22 x 2,5	19,5	100	34	18	14,500220	137,200022	45,73	45,7300022	45,73
M 24 x 3	21	110	38	18	14,500240	153,480024	51,16	51,1600024	51,16
M 27 x 3	24	110	38	20	1600270	207,280027	69,10	69,100027	69,10
M 30 x 3,5	26,5	125	45	22	1800300	261,960030	87,32	87,3200030	87,32
M 33 x 3,5	29,5	125	50	25	2000330	372,950033	124,32	124,3200033	124,32
M 36 x 4	32	150	56	28	2200360	530,030036	176,68	176,6800036	176,68
M 39 x 4	35	150	60	32	2400390	565,890039	188,63	188,6300039	188,63
M 42 x 4,5	37,5	150	60	32	2400420	668,720042	222,92	222,9200042	222,92
M 45 x 4,5	40,5	160	65	36	2900450	745,550045	248,51	248,5100045	248,51
M 48 x 5	43	180	70	36	2900480	879,740048	293,25	293,2500048	293,25
M 52 x 5	47	180	70	40	3200520	1014,540052	338,17	338,1700052	338,17

M 518S



M 519S

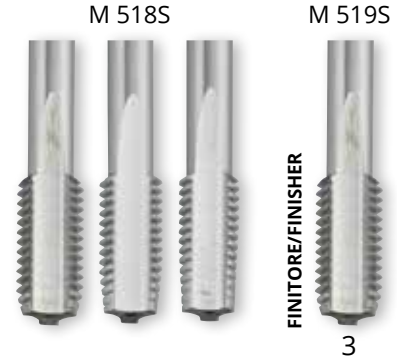
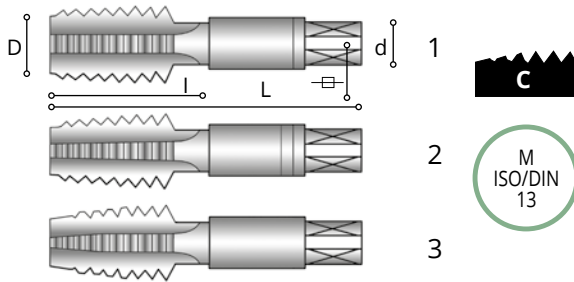

D		L	I	d		CODE	HSS 5518..... €	HSS 5519..... €
M 3 x 0,5	2,5	40	11	3,5	2,700003	36,31	12,10
M 3,5 x 0,6	2,9	45	12	4	300035	42,67	14,22
M 4 x 0,7	3,3	45	13	4,5	3,400004	34,99	11,66
M 4,5 x 0,75	3,8	50	16	6	4,900045	49,43	16,48
M 5 x 0,8	4,2	50	16	6	4,900005	36,31	12,10
M 6 x 1	5	50	19	6	4,900006	38,33	12,78
M 7 x 1	6	50	19	6	4,900007	50,78	16,92
M 8 x 1,25	6,8	63	22	6	4,900008	42,70	14,23
M 9 x 1,25	7,8	63	22	7	5,500009	65,95	21,98
M 10 x 1,5	8,5	70	24	7	5,500010	52,27	17,42
M 12 x 1,75	10,2	75	28	9	700012	66,84	22,28
M 14 x 2	12	80	30	11	900014	85,59	28,52
M 16 x 2	14	80	32	12	900016	105,48	35,17
M 18 x 2,5	15,5	95	34	14	1100018	149,31	49,78
M 20 x 2,5	17,5	95	34	16	1200020	157,64	52,56
M 22 x 2,5	19,5	100	34	18	14,500022	188,57	62,87
M 24 x 3	21	110	38	18	14,500024	210,33	70,11
M 27 x 3	24	110	38	20	1600027	282,53	94,18
M 30 x 3,5	26,5	125	45	22	1800030	352,59	117,53
M 33 x 3,5	29,5	125	50	25	2000033	433,33	144,44
M 36 x 4	32	150	56	28	2200036	511,01	170,34
M 39 x 4	35	150	60	32	2400039	663,30	221,11

M 523 INOX

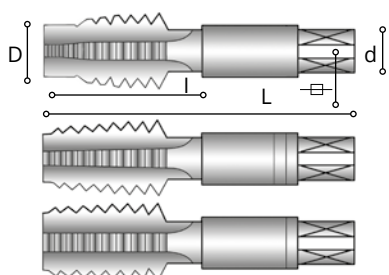

1



2



3



D		L	l	d		CODE	HSS-E 5523..... €	HSS-E 6523..... € QUARTZ
M 3 x 0,5	2,5	40	10	3,5	2,700003	43,82	57,37
M 4 x 0,7	3,3	45	12	4,5	3,400004	43,82	57,37
M 5 x 0,8	4,2	50	14	6	4,900005	44,18	62,23
M 6 x 1	5	56	16	6	4,900006	45,06	68,26
M 8 x 1,25	6,8	63	20	6	4,900008	54,03	81,60
M 10 x 1,5	8,5	70	22	7	5,500010	73,13	112,54
M 12 x 1,75	10,2	75	24	9	700012	89,68	142,49
M 14 x 2	12	80	26	11	900014	133,43	191,99
M 16 x 2	14	80	27	12	900016	162,46	228,54
M 18 x 2,5	15,5	95	30	14	1100018	221,24	314,42
M 20 x 2,5	17,5	95	32	16	1200020	266,61	356,05

M 595
HRC40

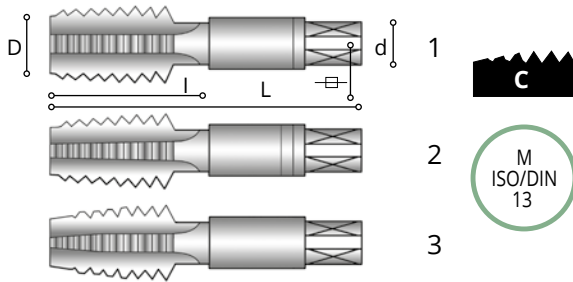

D		L	l	d		CODE	RESISTOR 8595..... € OPAL
M 3 x 0,5	2,5	40	10	3,5	2,730030	74,65
M 4 x 0,7	3,3	50	12	6	4,940030	74,65
M 5 x 0,8	4,2	50	14	6	4,950030	80,12
M 6 x 1	5	56	16	6	4,960030	87,29
M 8 x 1,25	6,8	63	20	6	4,980030	106,54
M 10 x 1,5	8,5	70	22	7	5,510030	147,38
M 12 x 1,75	10,2	75	24	9	712030	199,39
M 16 x 2	14	80	27	12	916030	315,25
M 20 x 2,5	17,5	95	32	16	1220030	492,63

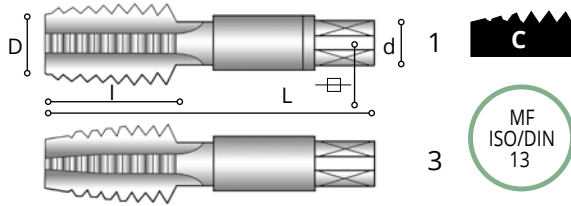

MF 510



M510



D		L	l	d		CODE	HSS 5510..... €
MF 3 x 0,35	2,65	40	8	3,5	2,7	...00003	32,81
MF 4 x 0,5	3,5	45	10	4,5	3,4	...00004	27,06
MF 4,5 x 0,5	4	50	12	6	4,9	...00045	40,78
MF 5 x 0,5	4,5	50	12	6	4,9	...00005	29,39
MF 5,5 x 0,5	5	50	12	6	4,9	...00055	48,02
MF 6 x 0,5	5,5	50	14	6	4,9	...50006	31,87
MF 6 x 0,75	5,3	50	14	6	4,9	...75006	31,08
MF 7 x 0,75	6,2	50	14	6	4,9	...75007	37,09
MF 8 x 0,5	7,5	50	18	6	4,9	...50008	38,84
MF 8 x 0,75	7,3	50	18	6	4,9	...75008	36,64
MF 8 x 1	7	56	22	6	4,9	...10008	28,89
MF 9 x 0,75	8,2	56	18	7	5,5	...75009	47,19
MF 9 x 1	8	63	22	7	5,5	...10009	46,58
MF 10 x 0,75	9,3	63	20	7	5,5	...75010	45,75
MF 10 x 1	9	63	20	7	5,5	...10010	32,96
MF 10 x 1,25	8,8	70	24	7	5,5	...12510	37,99
MF 11 x 1	10	63	20	8	6,2	...10011	52,00
MF 12 x 1	11	70	22	9	7	...10012	41,70
MF 12 x 1,25	10,8	70	22	9	7	...12512	42,23
M 12 x 1,5	10,5	70	22	9	7	...15012	39,48
MF 14 x 1	13	70	22	11	9	...10014	52,47
MF 14 x 1,25	12,8	70	22	11	9	...12514	53,38
MF 14 x 1,5	12,5	70	22	11	9	...15014	50,30
MF 15 x 1	14	70	22	12	9	...10015	66,76
MF 15 x 1,5	13,5	70	22	12	9	...15015	59,08
MF 16 x 1	15	70	22	12	9	...10016	57,82
MF 16 x 1,25	14,8	70	22	12	9	...12516	58,98
MF 16 x 1,5	14,5	70	22	12	9	...15016	49,96
MF 18 x 1	17	80	22	14	11	...10018	78,60
MF 18 x 1,5	16,5	80	22	14	11	...15018	75,20
MF 18 x 2	16	80	22	14	11	...20018	96,22
MF 20 x 1	19	80	22	16	12	...10020	84,96
MF 20 x 1,5	18,5	80	22	16	12	...15020	74,82
MF 20 x 2	18	80	22	16	12	...20020	103,20
MF 22 x 1	21	80	22	18	14,5	...10022	115,48
MF 22 x 1,5	20,5	80	22	18	14,5	...00022	90,16
MF 22 x 2	20	80	22	18	14,5	...20022	117,28
MF 24 x 1	23	90	22	18	14,5	...10024	140,01
MF 24 x 1,5	22,5	90	22	18	14,5	...00024	105,80
MF 24 x 2	22	90	22	18	14,5	...20024	124,30

D		L	I	d		CODE	HSS 5510..... €
MF 25 x 1	24	90	22	18	14,510025	140,01
MF 25 x 1,5	23,5	90	22	18	14,515025	136,55
MF 25 x 2	23	90	22	18	14,520025	140,05
MF 26 x 1,5	24,5	90	22	18	14,515026	156,62
MF 27 x 1	26	90	22	20	1610027	183,51
MF 27 x 1,5	25,5	90	22	20	1615027	156,62
MF 27 x 2	25	90	22	20	1620027	168,27
MF 28 x 1,5	26,5	90	22	20	1615028	156,83
MF 28 x 2	26	90	22	20	1620028	156,92
MF 30 x 1,5	28,5	90	22	22	1815030	186,67
MF 30 x 2	28	90	22	22	1820030	208,23
MF 32 x 1,5	30,5	90	22	22	1815032	211,53
MF 33 x 1,5	31,5	100	25	25	2015033	281,92
MF 33 x 2	31	100	25	25	2020033	302,70
MF 35 x 1,5	33,5	100	25	28	2215035	281,92
MF 36 x 1,5	34,5	100	25	28	2215036	326,77
MF 36 x 2	34	125	40	28	2220036	326,77
MF 36 x 3	33	125	40	28	2230036	339,04
MF 39 x 1,5	37,5	110	25	32	2415039	418,85
MF 39 x 2	37	125	40	32	2420039	461,59
MF 39 x 3	36	125	40	32	2430039	461,59
MF 40 x 1,5	38,5	110	25	32	2415040	361,46
MF 40 x 2	38	125	40	32	2420040	361,46
MF 40 x 3	37	125	40	32	2430040	361,46
MF 42 x 1,5	40,5	110	25	32	2415042	411,25
MF 42 x 2	40	125	40	32	2420042	414,58
MF 42 x 3	39	125	40	32	2430042	413,41
MF 45 x 1,5	43,5	110	25	36	2915045	487,40
MF 45 x 2	43	125	40	36	2920045	489,05
MF 45 x 3	42	125	40	36	2930045	487,99
MF 48 x 1,5	46,5	140	40	36	2915048	548,31
MF 48 x 2	46	140	40	36	2920048	548,77
MF 48 x 3	45	140	40	36	2930048	548,77
MF 50 x 1,5	48,5	140	40	36	2915050	654,93
MF 50 x 2	48	140	40	36	2920050	658,44
MF 50 x 3	47	140	40	36	2930050	658,44
MF 52 x 1,5	50,5	140	40	40	3215052	715,86
MF 52 x 2	50	140	40	40	3220052	717,39
MF 52 x 3	49	140	40	40	3230052	717,39

MF 596
HRC40

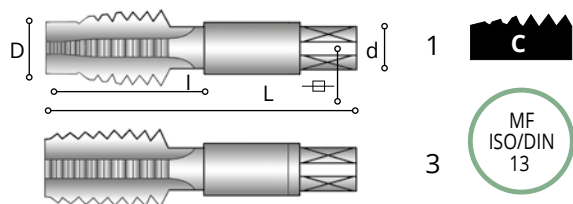

MF596



D		L	l	d		CODE	RESISTOR 8596..... € OPAL
MF 8 x 1	7	63	17	6	4,9	...10008	85,77
MF 10 x 1	9	63	18	7	5,5	...10010	120,99
MF 12 x 1,5	10,5	70	20	9	7	...15012	158,56
MF 16 x 1,5	14,5	70	20	12	9	...15016	256,94

G 540

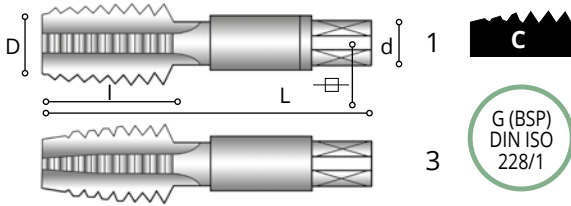

D	D (mm)		L	l	d		CODE	HSS 5540..... €
G 1/8 - 28	9,73	8,8	63	20	7	5,500108	44,01
G 1/4 - 19	13,16	11,8	70	22	11	900104	59,65
G 3/8 - 19	16,66	15,25	70	22	12	900308	72,36
G 1/2 - 14	20,96	19	80	22	16	1200102	103,16
G 5/8 - 14	22,91	21	80	22	18	14,500508	125,05
G 3/4 - 14	26,44	24,5	90	22	20	1600304	151,86
G 7/8 - 14	30,20	28,25	90	22	22	1800708	209,50
G 1" - 11	33,25	30,75	100	25	25	2000100	245,76
G 1" 1/8 - 11	37,90	35	125	40	28	2201108	376,74
G 1" 1/4 - 11	41,91	39,5	125	40	32	2401104	440,74
G 1" 3/8 - 11	44,32	42	125	40	36	2901308	513,39
G 1" 1/2 - 11	47,80	45	140	40	36	2901102	556,50
G 1" 3/4 - 11	53,75	51	140	40	40	3201304	650,80
G 2" - 11	59,61	57	160	40	45	3500200	814,40

G 555 INOX

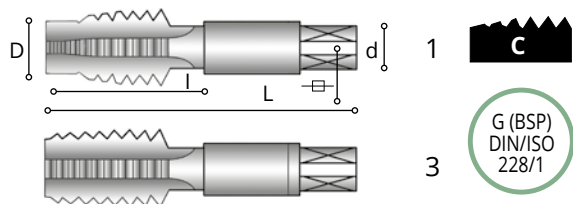

G (BSP)
DIN/ISO
228/1

G555



D	D (mm)		L	l	d		CODE	HSS-E 5555..... €
G 1/8-28	9,73	8,8	63	18	7	5,500108	67,22
G 1/4-19	13,16	11,8	70	22	11	900104	87,27
G 3/8-19	16,66	15,25	70	22	12	900308	108,47
G 1/2-14	20,96	19	80	22	16	1200102	140,83

G 554 HRC40

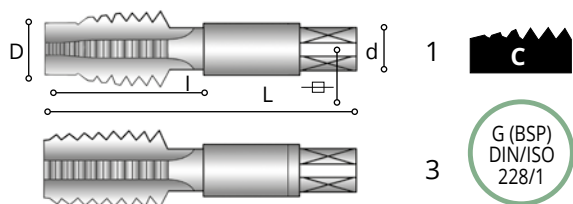

G (BSP)
DIN/ISO
228/1

G554



D	D (mm)		L	l	d		CODE	RESISTOR 8554..... € OPAL
G 1/8-28	9,73	8,8	63	18	7	5,510830	133,59
G 1/4-19	13,16	11,8	70	22	11	910430	233,98
G 3/8-19	16,66	15,25	70	22	12	930830	294,97
G 1/2-14	20,96	19	80	22	16	1210230	409,23

UNC 556

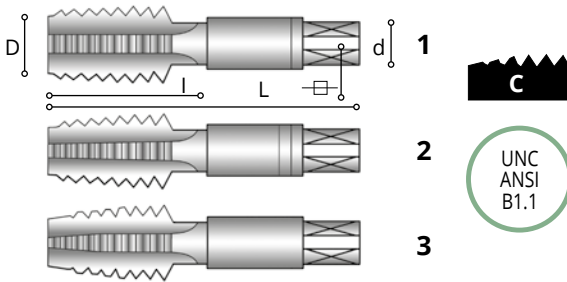

UNC556



D	D (mm)		L	I	d		CODE	HSS 5556..... €
UNC 5 - 40	3,175	2,65		11	3,5	2,700540	44,13
UNC 6 - 32	3,505	2,85	45	12	4	300632	44,13
UNC 8 - 32	4,166	3,5	45	13	4,5	3,400832	44,13
UNC 10 - 24	4,826	3,9	50	16	6	4,901024	52,15
UNC 12 - 24	5,486	4,5	50	16	6	4,901224	52,15
UNC 1/4 - 20	6,35	5,1	50	19	6	4,901420	52,15
UNC 5/16 - 18	7,938	6,6	56	22	6	4,951618	57,96
UNC 3/8 - 16	9,525	8	63	22	7	5,503816	62,68
UNC 7/16 - 14	11,11	9,4	70	24	8	6,271614	77,25
UNC 1/2 - 13	12,7	10,8	75	28	9	771213	89,88
UNC 9/16 - 12	14,29	12,2	80	30	11	991612	120,66
UNC 5/8 - 11	15,88	13,5	80	32	12	905811	127,42
UNC 3/4 - 10	19,05	16,5	95	34	14	1103410	164,77
UNC 7/8 - 9	22,23	19,5	100	34	18	14,507809	208,35
UNC 1" - 8	25,4	22,25	110	38	18	14,501008	279,49
UNC 1" 1/8 - 7	28,58	25	125	45	22	1811807	372,67
UNC 1" 1/4 - 7	31,75	28	125	50	25	2011407	387,71
UNC 1" 3/8 - 6	34,93	30,75	150	56	28	2213806	539,68
UNC 1" 1/2 - 6	38,1	34	150	60	32	2411206	617,50

UNF 558

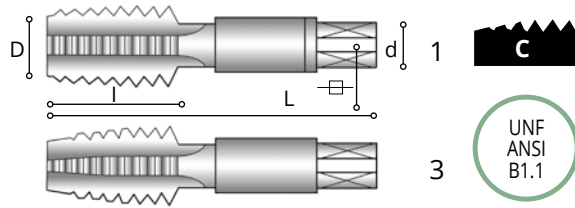

UNF558



D	D (mm)		L	l	d		CODE	HSS 5558..... €
UNF 5 - 44	3,175	2,7	40	11	3,5	2,7	...00544	33,72
UNF 6 - 40	3,505	2,95	45	13	4	3	...00640	33,77
UNF 8 - 36	4,166	3,5	45	13	4,5	3,4	...00836	33,33
UNF 10 - 32	4,826	4,1	50	16	6	4,9	...01032	33,33
UNF 12 - 28	5,486	4,7	50	16	6	4,9	...01228	38,74
UNF 1/4 - 28	6,35	5,5	50	19	6	4,9	...01428	38,68
UNF 5/16 - 24	7,938	6,9	56	22	6	4,9	...51624	43,03
UNF 3/8 - 24	9,525	8,5	63	22	7	5,5	...03824	47,27
UNF 7/16 - 20	11,11	9,9	63	22	8	6,2	...71620	57,04
UNF 1/2 - 20	12,7	11,5	63	22	9	7	...01220	66,68
UNF 9/16 - 18	14,29	12,9	70	22	11	9	...91618	87,51
UNF 5/8 - 18	15,88	14,5	70	22	12	9	...05818	79,42
UNF 3/4 - 16	19,05	17,5	80	25	14	11	...03416	121,22
UNF 7/8 - 14	22,23	20,4	80	25	18	14,5	...07814	129,43
UNF 1" - 12	25,4	23,25	80	28	18	14,5	...01012	179,67
UNF 1" 1/8 - 12	28,58	26,5	90	28	22	18	...11812	231,89
UNF 1" 1/4 - 12	31,75	29,5	90	28	22	18	...11412	284,91
UNF 1" 3/8 - 12	34,93	32,75	125	38	28	22	...13812	409,44
UNF 1" 1/2 - 12	38,1	36	125	38	28	22	...11212	462,89

M 508

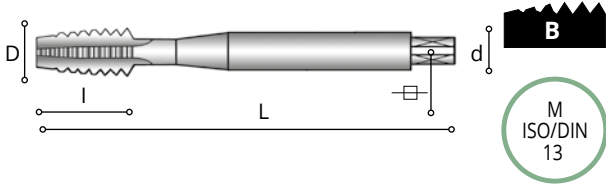

M508



D		L	l	d		CODE	HSS-EX 5508..... €	HSS-EX 6508..... € QUARTZ	HSS-EX 7508..... € TITANITE	CODE	RESISTOR 8508..... € OPAL
M 2 x 0,4	1,6	45	8	2,8	2,100002	19,68	23,60	25,06		
M 2,5 x 0,45	2	50	9	2,8	2,100025	19,68	23,60	25,06		
M 2,6 x 0,45	2,1	50	9	2,8	2,100026	19,68	23,60	25,06		
M 3 x 0,5	2,5	56	10	3,5	2,700003	15,26	18,73	20,2130030	41,98
M 3,5 x 0,6	2,9	56	12	4	300035	16,38	19,97	21,42		
M 4 x 0,7	3,3	63	12	4,5	3,400004	15,50	19,69	21,7340030	41,98
M 5 x 0,8	4,2	70	14	6	4,900005	16,37	20,64	22,6750030	41,98
M 6 x 1	5	80	18	6	4,900006	16,37	20,64	23,9460030	41,98
M 7 x 1	6	80	18	7	5,500007	18,33	24,15	27,21		
M 8 x 1,25	6,8	90	20	8	6,200008	18,65	24,50	27,5580030	54,86
M 10 x 1,5	8,5	100	20	10	800010	23,53	30,61	34,3010030	66,78

M 502

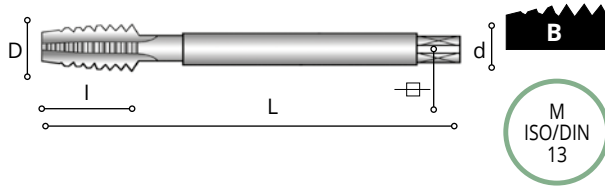

M502

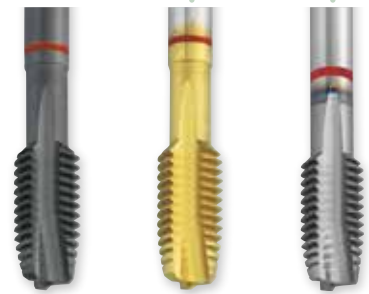

D		L	I	d		CODE	HSS-EX 5502..... €	HSS-EX 6502..... € QUARTZ	HSS-EX 7502..... € TITANITE
M 3 x 0,5	2,5	56	11	2,2	-00003	17,62	21,33	22,80
M 4 x 0,7	3,3	63	13	2,8	2,100004	17,62	21,33	22,80
M 5 x 0,8	4,2	70	16	3,5	2,700005	17,62	22,02	24,06
M 6 x 1	5	80	19	4,5	3,400006	17,62	22,47	25,31
M 7 x 1	6	80	19	5,5	4,300007	21,10	27,18	30,24
M 8 x 1,25	6,8	90	22	6	4,900008	20,31	26,31	29,37
M 10 x 1,5	8,5	100	24	7	5,500010	23,61	30,70	34,38
M 11 x 1,5	9,5	100	24	8	6,200011	36,87	45,28	48,97
M 12 x 1,75	10,2	110	28	9	700012	28,09	36,97	41,67
M 14 x 2	12	110	30	11	900014	39,82	50,49	55,68
M 16 x 2	14	110	32	12	900016	45,23	56,46	61,64
M 18 x 2,5	15,5	125	34	14	1100018	59,56	73,19	79,12
M 20 x 2,5	17,5	140	34	16	1200020	67,04	83,28	90,64
M 22 x 2,5	19,5	140	34	18	14,500022	84,56	102,56	109,93
M 24 x 3	21	160	38	18	14,500024	90,40	112,78	142,50
M 27 x 3	24	160	38	20	1600027	122,88	166,12	189,97
M 30 x 3,5	26,5	180	45	22	1800030	149,93	195,87	219,72
M 33 x 3,5	29,5	180	50	25	2000033	202,00	256,60	283,14
M 36 x 4	32	200	56	28	2200036	282,39	356,15	391,30
M 39 x 4	35	200	60	32	2400039	351,70	432,39	467,52
M 42 x 4,5	37,5	200	60	32	2400042	418,64	524,10	573,21

M 503



M 521S

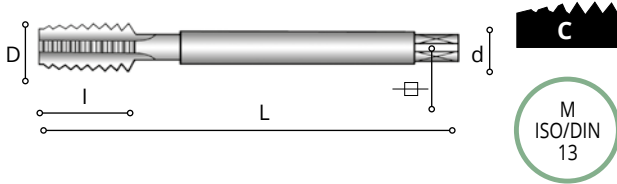

M503

M 521S

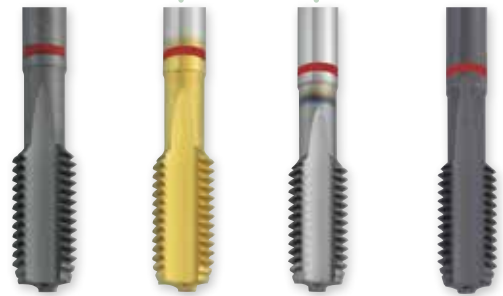

D		L	l	d		CODE	HSS-EX 5503..... €	HSS-EX 6503..... € QUARTZ	HSS-EX 7503..... € TITANITE	HSS-EX 5521..... €
M 3 x 0,5	2,5	56	11	2,2	-00003	14,63	18,05	19,51	25,35
M 4 x 0,7	3,3	63	13	2,8	2,100004	16,53	20,13	21,59	25,96
M 5 x 0,8	4,2	70	16	3,5	2,700005	16,53	20,82	22,84	25,96
M 6 x 1	5	80	19	4,5	3,400006	16,53	21,27	24,11	25,96
M 7 x 1	6	80	19	5,5	4,300007	20,63	26,67	29,72	
M 8 x 1,25	6,8	90	22	6	4,900008	16,53	22,16	25,21	29,02
M 10 x 1,5	8,5	100	24	7	5,500010	20,15	26,90	30,57	34,11
M 11 x 1,5	9,5	100	24	8	6,200011	29,40	37,06	40,74	
M 12 x 1,75	10,2	110	28	9	700012	25,64	34,29	38,98	43,88
M 14 x 2	12	110	30	11	900014	34,70	44,87	50,05	54,82
M 16 x 2	14	110	32	12	900016	42,10	53,02	58,19	62,67
M 18 x 2,5	15,5	125	34	14	1100018	56,64	69,99	75,92	88,63
M 20 x 2,5	17,5	140	34	16	1200020	60,34	75,92	83,28	103,90
M 22 x 2,5	19,5	140	34	18	14,500022	81,66	99,36	106,72	120,01
M 24 x 3	21	160	38	18	14,500024	87,48	109,58	139,30	126,94
M 27 x 3	24	160	38	20	1600027	114,61	157,01	180,87	170,85
M 30 x 3,5	26,5	180	45	22	1800030	136,34	180,90	204,76	197,57
M 33 x 3,5	29,5	180	50	25	2000033	199,97	254,36	280,90	255,20
M 36 x 4	32	200	56	28	2200036	223,17	291,00	326,13	303,12
M 39 x 4	35	200	60	32	2400039	291,14	365,78	400,91	359,27
M 42 x 4,5	37,5	200	60	32	2400042	327,96	424,34	473,45	
M 45 x 4,5	40,5	220	65	36	2900045	343,23	455,89	516,34	
M 48 x 5	43	250	70	36	2900048	410,03	529,37	589,82	
M 52 x 5	47	250	70	40	3200052	514,47	656,12	706,58	

M 509

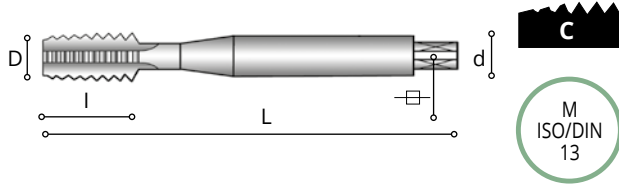

M509



D		L	I	d		CODE	HSS-EX 5509..... €	HSS-EX 6509..... € QUARTZ	HSS-EX 7509..... € TITANITE
M 2 x 0,4	1,6	45	8	2,8	2,100002	20,31	24,28	25,75
M 2,5 x 0,45	2	50	9	2,8	2,100025	20,31	24,28	25,75
M 2,6 x 0,45	2,1	50	9	2,8	2,100026	20,31	24,28	25,75
M 3 x 0,5	2,5	56	10	3,5	2,700003	13,68	17,01	18,48
M 3,5 x 0,6	2,9	56	12	4	300035	16,78	20,39	21,86
M 4 x 0,7	3,3	63	12	4,5	3,400004	13,69	17,69	19,73
M 5 x 0,8	4,2	70	14	6	4,900005	14,56	18,65	20,69
M 6 x 1	5	80	18	6	4,900006	14,56	18,65	21,94
M 7 x 1	6	80	18	7	5,500007	16,37	22,00	25,04
M 8 x 1,25	6,8	90	20	8	6,200008	17,16	22,85	25,90
M 10 x 1,5	8,5	100	20	10	800010	19,99	26,71	30,39

M 514

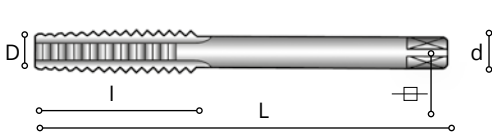

~12P

M
ISO/DIN
13

M514



D		L	I	d		CODE	HSS-EX 5514..... €	HSS-EX 6514..... € QUARTZ	HSS-EX 7514..... € TITANITE
M 4 x 0,7	3,3	90	25	2,8	2,100004	26,51	31,65	33,59
M 5 x 0,8	4,2	100	28	3,5	2,700005	28,17	34,32	36,90
M 6 x 1	5	110	32	4,5	3,400006	29,82	36,78	39,87
M 8 x 1,25	6,8	125	40	6	4,900008	37,53	46,19	50,00
M 10 x 1,5	8,5	140	45	7	5,500010	41,93	52,20	56,90
M 12 x 1,75	10,2	180	50	9	700012	55,23	68,09	73,77
M 14 x 2	12	200	56	11	900014	77,80	97,63	106,94
M 16 x 2	14	200	63	12	900016	91,09	112,27	121,58
M 18 x 2,5	15,5	220	63	14	1100018	110,36	141,45	156,93
M 20 x 2,5	17,5	250	70	16	1200020	122,56	163,76	186,12

M 511

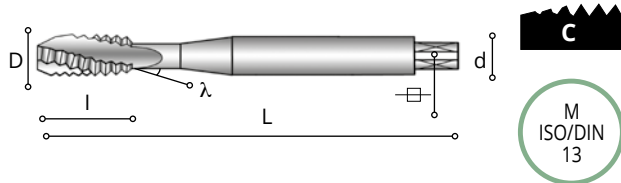

M511

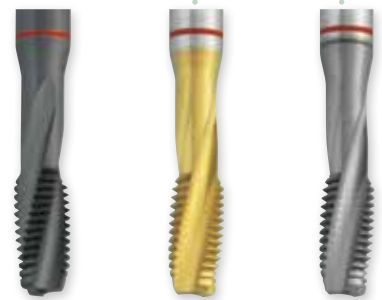

D		L	I	d		CODE	HSS-EX 5511..... €	HSS-EX 6511..... € QUARTZ	HSS-EX 7511..... € TITANITE
M 2 x 0,4	1,6	45	8	2,8	2,100002	20,17	24,15	25,61
M 2,5 x 0,45	2	50	9	2,8	2,100025	18,10	21,86	23,31
M 2,6 x 0,45	2,1	50	9	2,8	2,100026	18,10	21,86	23,31
M 3 x 0,5	2,5	56	11	3,5	2,700003	16,37	19,96	21,42
M 4 x 0,7	3,3	63	13	4,5	3,400004	16,37	20,64	22,67
M 5 x 0,8	4,2	70	15	6	4,900005	17,16	21,50	23,53
M 6 x 1	5	80	17	6	4,900006	18,09	23,25	25,82
M 7 x 1	6	80	17	7	5,500007	19,04	24,93	27,97
M 8 x 1,25	6,8	90	20	8	6,200008	19,99	25,96	29,01
M 10 x 1,5	8,5	100	20	10	800010	24,63	31,82	35,50

M 505

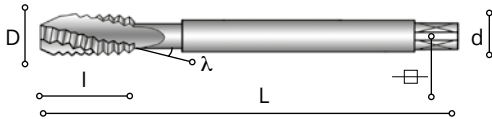

D		L	I	d		CODE	HSS-EX 5505..... €	HSS-EX 6505..... € QUARTZ	HSS-EX 7505..... € TITANITE
M 3 x 0,5	2,5	56	11	2,2	-00003	18,33	22,12	23,58
M 4 x 0,7	3,3	63	13	2,8	2,100004	19,04	22,89	24,35
M 5 x 0,8	4,2	70	16	3,5	2,700005	18,18	22,64	24,67
M 6 x 1	5	80	19	4,5	3,400006	19,99	25,34	27,91
M 7 x 1	6	80	19	5,5	4,300007	20,31	26,31	29,37
M 8 x 1,25	6,8	90	22	6	4,900008	21,79	27,96	31,01
M 10 x 1,5	8,5	100	24	7	5,500010	27,14	34,58	38,27
M 12 x 1,75	10,2	110	28	9	700012	30,92	40,09	44,78
M 14 x 2	12	110	30	11	900014	42,65	53,62	58,79
M 16 x 2	14	110	32	12	900016	48,93	60,53	65,72
M 18 x 2,5	15,5	125	34	14	1100018	67,04	81,43	87,35
M 20 x 2,5	17,5	140	34	16	1200020	75,23	92,45	99,92
M 22 x 2,5	19,5	140	34	18	14,500022	90,70	109,31	116,67
M 24 x 3	21	160	38	18	14,500024	96,14	130,05	148,82
M 27 x 3	24	160	38	20	1600027	132,78	177,47	201,68
M 30 x 3,5	26,5	180	45	22	1800030	158,19	204,95	228,80
M 33 x 3,5	29,5	180	50	25	2000033	215,46	271,38	297,94
M 36 x 4	32	200	56	28	2200036	258,14	330,16	365,82

M 512

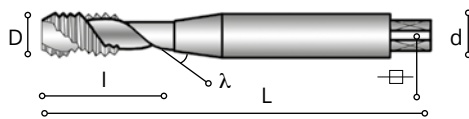

M 512

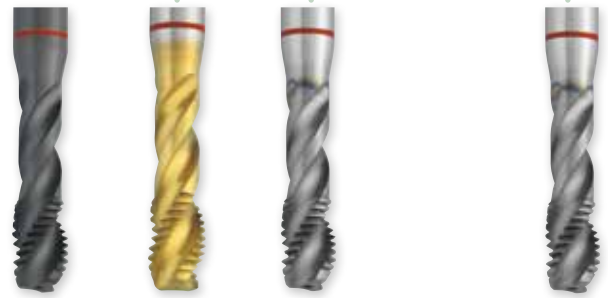

D		L	I	d		CODE	HSS-EX 5512..... €	HSS-EX 6512..... € QUARTZ	HSS-EX 7512..... € TITANITE	CODE	RESISTOR 8512..... € OPAL
M 2 x 0,4	1,6	45	8	2,8	2,100002	21,64	25,75	27,21		
M 2,5 x 0,45	2	50	9	2,8	2,100025	21,64	25,75	27,21		
M 2,6 x 0,45	2,1	50	9	2,8	2,100026	21,64	25,75	27,21		
M 3 x 0,5	2,5	56	5	3,5	2,700003	16,37	19,96	21,4230030	44,09
M 4 x 0,7	3,3	63	7	4,5	3,400004	17,16	21,50	23,5340030	44,09
M 5 x 0,8	4,2	70	8	6	4,900005	18,09	22,53	24,5750030	44,09
M 6 x 1	5	80	10	6	4,900006	18,09	23,25	25,8260030	44,09
M 7 x 1	6	80	10	7	5,500007	18,67	24,52	27,56		
M 8 x 1,25	6,8	90	13	8	6,200008	20,86	26,91	29,9780030	57,78
M 10 x 1,5	8,5	100	15	10	800010	24,63	31,82	35,5010030	70,39

M 506

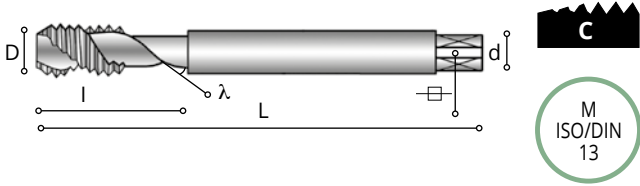

D		L	l	d		CODE	HSS-EX 5506..... €	HSS-EX 6506..... € QUARTZ	HSS-EX 7506..... € TITANITE
M 3 x 0,5	2,5	56	5	2,2	-00003	18,09	21,85	23,31
M 4 x 0,7	3,3	63	7	2,8	2,100004	17,94	21,68	23,15
M 5 x 0,8	4,2	70	8	3,5	2,700005	17,59	21,98	24,02
M 6 x 1	5	80	10	4,5	3,400006	18,81	24,04	26,62
M 7 x 1	6	80	10	5,5	4,300007	20,31	26,31	29,37
M 8 x 1,25	6,8	90	13	6	4,900008	21,94	28,13	31,18
M 10 x 1,5	8,5	100	15	7	5,500010	27,39	34,85	38,54
M 12 x 1,75	10,2	110	18	9	700012	31,24	40,43	45,13
M 14 x 2	12	110	20	11	900014	42,95	53,95	59,12
M 16 x 2	14	110	20	12	900016	49,33	60,97	66,15
M 18 x 2,5	15,5	125	25	14	1100018	67,65	82,12	88,03
M 20 x 2,5	17,5	140	25	16	1200020	73,13	89,99	97,35
M 22 x 2,5	19,5	140	25	18	14,500022	91,57	110,27	117,63
M 24 x 3	21	160	30	18	14,500024	96,99	130,99	149,76
M 27 x 3	24	160	38	20	1600027	134,07	178,87	203,08
M 30 x 3,5	26,5	180	45	22	1800030	159,69	206,61	230,47
M 33 x 3,5	29,5	180	50	25	2000033	200,80	255,78	282,73
M 36 x 4	32	200	56	28	2200036	330,15	409,37	445,03
M 39 x 4	35	200	40	32	2400039	462,42	543,42	578,42
M 42 x 4,5	37,5	200	45	32	2400042	550,53	631,05	659,53

MF 520

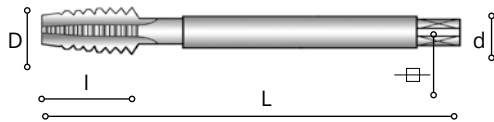

MF520

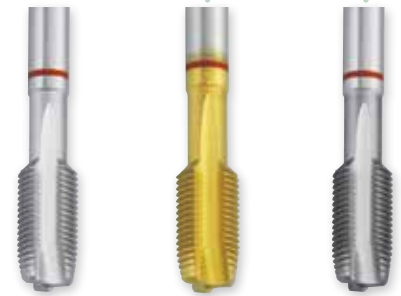

D		L	l	d		CODE	HSS-EX 5520..... €	HSS-EX 6520..... € QUARTZ	HSS-EX 7520..... € TITANITE
MF 4 x 0,5	3,5	63	10	2,8	2,100004	26,21	30,77	32,24
MF 5 x 0,5	4,5	70	12	3,5	2,700005	26,21	31,46	33,50
MF 5,5 x 0,5	5	80	12	4	300055	34,32	41,11	43,68
MF 6 x 0,5	5,5	80	14	4,5	3,405006	27,97	34,13	36,71
MF 6 x 0,75	5,3	80	14	4,5	3,407506	26,21	32,18	34,75
MF 7 x 0,75	6,2	80	14	5,5	4,307507	29,17	36,15	39,27
MF 8 x 0,75	7,3	80	18	6	4,907508	29,91	36,87	39,93
MF 8 x 1	7	90	20	6	4,910008	27,17	33,87	36,93
MF 10 x 0,75	9,2	90	20	7	5,507510	33,22	41,27	44,95
MF 10 x 1	9	90	20	7	5,510010	34,14	42,28	45,96
MF 10 x 1,25	8,8	100	20	7	5,512510	34,14	42,28	45,96
MF 11 x 1	10	90	20	8	6,210011	42,28	51,32	55,08
MF 12 x 1	11	100	20	9	710012	39,92	48,64	52,32
MF 12 x 1,25	10,8	100	20	9	712512	38,75	47,36	51,04
MF 12 x 1,5	10,5	100	20	9	715012	38,75	47,36	51,04
MF 14 x 1	13	100	20	11	910014	49,13	59,24	63,26
MF 14 x 1,25	12,8	100	20	11	912514	54,74	65,32	69,30
MF 14 x 1,5	12,5	100	20	11	915014	54,74	65,32	69,30
MF 15 x 1	14	100	20	12	910015	62,67	74,14	78,18
MF 15 x 1,5	13,5	100	20	12	915015	61,74	73,04	77,02
MF 16 x 1	15	100	20	12	910016	66,01	77,73	81,71
MF 16 x 1,5	14,5	100	20	12	915016	63,87	75,37	79,34
MF 18 x 1	17	110	24	14	1110018	81,99	97,89	103,81
MF 18 x 1,5	16,5	110	24	14	1115018	76,36	91,81	97,83
MF 18 x 2	16	125	32	14	1120018	75,63	90,87	96,80
MF 20 x 1	19	125	24	16	1210020	88,87	107,31	114,66
MF 20 x 1,5	18,5	125	24	16	1215020	84,35	102,33	109,69
MF 20 x 2	18	140	32	16	1220020	79,74	97,25	104,61
MF 22 x 1	21	125	24	18	14,510022	96,60	115,80	123,17
MF 22 x 1,5	20,5	125	24	18	14,500022	91,10	109,77	117,14
MF 22 x 2	20	140	32	18	14,520022	115,35	136,43	143,79
MF 24 x 1	23	140	27	18	14,510024	127,23	153,29	163,58
MF 24 x 1,5	22,5	140	27	18	14,500024	102,49	126,08	136,38
MF 24 x 2	22	140	27	18	14,520024	129,57	155,86	166,16
MF 25 x 1,5	23,5	140	27	18	14,515025	141,57	169,09	179,38
MF 26 x 1,5	24,5	140	27	18	14,515026	123,17	150,92	162,86
MF 27 x 1,5	25,5	140	27	20	1615027	129,98	158,35	170,24
MF 27 x 2	25	140	27	20	1620027	131,51	160,02	171,91
MF 28 x 1,5	26,5	140	27	20	1615028	141,34	186,88	211,09
MF 28 x 2	26	140	27	20	1620028	145,72	191,71	215,92
MF 30 x 1,5	28,5	150	27	22	1815030	150,01	196,40	220,62
MF 30 x 2	28	150	27	22	1820030	150,01	196,40	220,62
MF 33 x 2	31	160	30	25	2020033	188,42	241,66	268,19
MF 36 x 3	33	200	56	28	2230036	252,54	324,01	359,66

MF 530



MF 522S

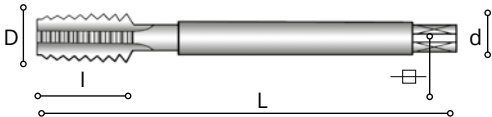

MF530

MF522S

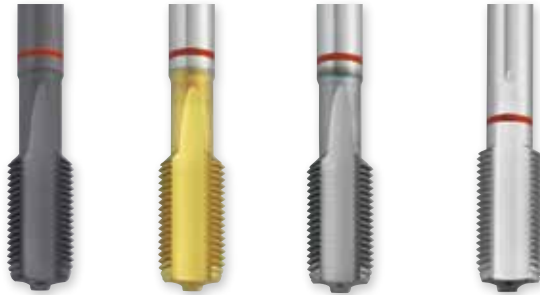

D		L	I	d		CODE	HSS-EX 5530..... €	HSS-EX 6530..... € QUARTZ	HSS-EX 7530..... € TITANITE	HSS-EX 5522..... €
MF 4 x 0,5	3,5	63	10	2,8	2,100004	23,76	28,07	29,55	45,72
MF 5 x 0,5	4,5	70	12	3,5	2,700005	24,16	29,21	32,49	45,72
MF 6 x 0,5	5,5	80	14	4,5	3,405006	25,64	31,57	34,14	
MF 6 x 0,75	5,3	80	14	4,5	3,407506	26,59	32,60	35,18	50,41
MF 7 x 0,75	6,2	80	14	5,5	4,307507	44,99	56,33	61,63	44,99
MF 8 x 0,75	7,3	80	18	6	4,907508	26,59	32,60	36,28	44,99
MF 8 x 1	7	90	20	6	4,910008	24,16	30,55	33,61	41,14
MF 9 x 1	8	90	20	7	5,510009	46,38	58,06	63,54	46,38
MF 10 x 0,75	9,2	90	20	7	5,507510	50,57	63,31	69,28	50,57
MF 10 x 1	9	90	20	7	5,510010	26,64	34,05	37,72	44,99
MF 10 x 1,25	8,8	100	20	7	5,512510	28,73	36,32	40,01	44,99
MF 11 x 1	10	90	20	8	6,210011	54,31	67,99	74,40	54,31
MF 12 x 1	11	100	20	9	710012	31,61	39,59	43,34	52,72
MF 12 x 1,25	10,8	100	20	9	712512	36,94	45,42	49,16	52,72
MF 12 x 1,5	10,5	100	20	9	715012	30,03	37,84	41,61	52,72
MF 14 x 1	13	100	20	11	910014	46,13	55,93	59,97	67,00
MF 14 x 1,25	12,8	100	20	11	912514	45,45	55,10	59,08	67,00
MF 14 x 1,5	12,5	100	20	11	900014	42,41	51,84	55,89	67,00
MF 15 x 1	14	100	20	12	910015	91,55	114,62	125,43	91,55
MF 16 x 1	15	100	20	12	910016	53,18	63,68	67,73	85,25
MF 16 x 1,5	14,5	100	20	12	900016	46,29	56,12	60,16	76,01
MF 18 x 1	17	110	24	14	1110018	67,89	82,39	88,30	97,74
MF 18 x 1,5	16,5	110	24	14	1100018	56,10	69,56	75,61	97,74
MF 18 x 2	16	125	32	14	1120018	67,89	82,39	88,30	
MF 20 x 1	19	125	24	16	1210020	79,68	97,20	104,57	107,88
MF 20 x 1,5	18,5	125	24	16	1200020	62,04	77,98	85,49	107,88
MF 20 x 2	18	140	32	16	1220020	79,53	97,03	104,39	
MF 22 x 1	21	125	24	18	14,510022	89,10	107,69	115,15	127,11
MF 22 x 1,5	20,5	125	24	18	14,500022	72,61	89,63	97,13	129,02
MF 22 x 2	20	140	32	18	14,520022	86,03	104,32	111,79	
MF 24 x 1	23	140	27	18	14,510024	111,55	136,06	146,36	146,70
MF 24 x 1,5	22,5	140	27	18	14,500024	77,44	98,81	109,30	148,90
MF 24 x 2	22	140	27	18	14,520024	100,28	123,86	134,31	181,59

MF 507

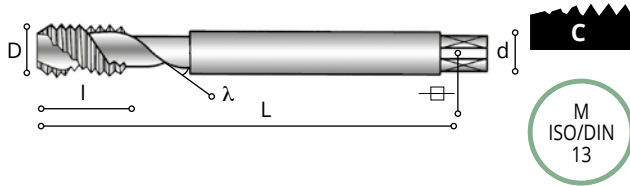

MF507

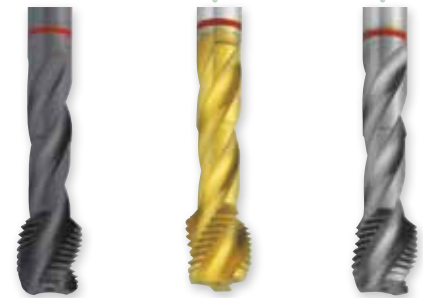

D		L	I	d		CODE	HSS-EX 5507..... €	HSS-EX 6507..... € QUARTZ	HSS-EX 7507..... € TITANITE
MF 4 x 0,5	3,5	63	7	2,8	2,100004	27,59	32,29	33,76
MF 5 x 0,5	4,5	70	8	6	4,900005	28,07	33,52	35,55
MF 6 x 0,5	5,5	80	10	4,5	3,400006	28,07	34,23	36,81
MF 8 x 1	7	90	13	6	4,900008	28,33	35,13	38,18
MF 10 x 1	9	90	13	7	5,500010	31,19	39,04	42,72
MF 10 x 1,25	8,8	100	15	7	5,512510	40,14	48,88	52,56
MF 12 x 1	11	100	15	9	710012	38,70	47,38	51,14
MF 12 x 1,25	10,8	100	15	9	712512	48,75	58,36	62,03
MF 12 x 1,5	10,5	100	15	9	715012	36,40	44,85	48,58
MF 14 x 1,25	12,8	100	15	11	912514	60,16	71,30	75,27
MF 14 x 1,5	12,5	100	15	11	900014	51,83	62,19	66,23
MF 16 x 1,5	14,5	100	15	12	900016	62,22	73,65	77,69
MF 18 x 1,5	16,5	110	17	14	1100018	70,98	85,88	91,90
MF 20 x 1,5	18,5	125	17	16	1200020	79,46	97,11	104,58
MF 22 x 1,5	20,5	125	17	18	14,500022	90,39	109,11	116,59
MF 24 x 1,5	22,5	140	20	18	14,500024	111,07	135,78	146,29
MF 24 x 2	22	140	20	18	14,520024	120,93	146,64	157,14
MF 25 x 1	24	140	20	18	14,510025	182,83	214,65	225,11
MF 25 x 1,5	23,5	140	20	18	14,515025	182,83	214,65	225,11
MF 26 x 1,5	24,5	140	20	18	14,515026	176,16	209,14	221,03
MF 27 x 1,5	25,5	140	20	20	1615027	173,56	206,05	217,76
MF 27 x 2	25	140	20	20	1620027	182,83	216,48	228,35
MF 28 x 1	27	140	20	20	1610028	225,83	263,79	275,66
MF 28 x 1,5	26,5	140	20	20	1615028	222,49	259,89	271,59
MF 28 x 2	26	140	20	20	1620028	226,94	265,09	277,02
MF 30 x 1,5	28,5	150	22	22	1815030	222,49	275,68	299,54
MF 30 x 2	28	150	22	22	1820030	223,06	276,77	300,98
MF 32 x 0,5	31,5	150	22	22	1800032	239,28	298,29	325,35
MF 32 x 1	31	150	22	22	1810032	239,28	298,29	325,35
MF 32 x 1,5	30,5	150	22	22	1815032	234,59	292,44	318,97
MF 32 x 2	30	150	22	22	1820032	233,40	291,13	317,67
MF 33 x 2	31	160	24	25	2020033	290,81	354,79	381,73
MF 34 x 1,5	32,5	170	24	28	2215034	343,65	413,08	440,16
MF 36 x 1,5	34,5	170	24	28	2215036	371,58	448,85	479,82
MF 36 x 3	33	200	30	28	2230036	371,58	454,94	490,60

G 550

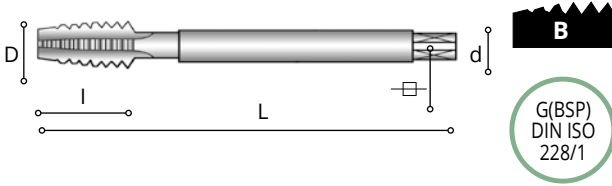

D	D (mm)		L	I	d		CODE	HSS-EX 5550..... €	HSS-EX 6550..... € QUARTZ	HSS-EX 7550..... € TITANITE
G 1/8 - 28	9,73	8,8	90	18	7	5,500108	37,20	45,65	49,35
G 1/4 - 19	13,16	11,8	100	22	11	900104	48,85	58,87	62,85
G 3/8 - 19	16,66	15,25	100	22	12	900308	64,35	76,92	81,64
G 1/2 - 14	20,96	19	125	25	16	1200102	83,94	101,87	109,23
G 5/8 - 14	22,91	21	125	25	18	14,500508	104,15	127,92	138,20
G 3/4 - 14	26,44	24,5	140	28	20	1600304	134,99	163,64	175,34
G 7/8 - 14	30,20	28,25	150	30	22	1800708	174,79	226,66	253,20
G 1" - 11	33,25	30,75	160	30	25	2000100	190,12	243,53	270,07
G 1" 1/8 - 11	37,90	35	170	30	28	2201108	284,35	352,92	383,87
G 1" 1/4 - 11	41,91	39,5	170	30	32	2401104	359,16	450,03	492,44
G 1" 3/8 - 11	44,32	42	180	32	36	2901308	420,96	517,20	558,98
G 1" 1/2 - 11	47,80	45	190	32	36	2901102	491,13	604,80	654,64
G 1" 3/4 - 11	53,75	51	190	32	40	3201304	638,02	783,88	830,14
G 2" - 11	59,61	57	220	40	45	3500200	774,74	946,92	1000,31

G 504

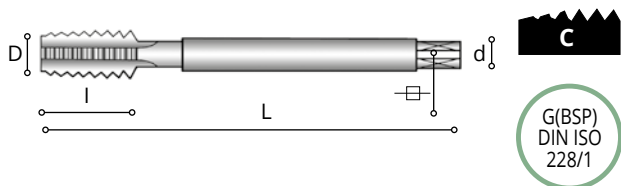

G504



D	D (mm)		L	I	d		CODE	HSS-EX 5504..... €	HSS-EX 6504..... € QUARTZ	HSS-EX 7504..... € TITANITE
G 1/8 - 28	9,73	8,8	90	18	7	5,500108	27,06	34,51	38,18
G 1/4 - 19	13,16	11,8	100	22	11	900104	36,51	45,28	49,26
G 3/8 - 19	16,66	15,25	100	22	12	900308	51,23	62,48	67,20
G 1/2 - 14	20,96	19	125	25	16	1200102	68,92	85,36	92,72
G 5/8 - 14	22,91	21	125	25	18	14,500508	88,89	111,13	121,42
G 3/4 - 14	26,44	24,5	140	28	20	1600304	105,95	131,70	143,41
G 7/8 - 14	30,20	28,25	150	28	22	1800708	150,08	199,49	226,02
G 1" - 11	33,25	30,75	160	30	25	2000100	173,07	224,76	251,31
G 1" 1/8 - 11	37,90	35	170	30	28	2200118	251,50	316,18	346,68
G 1" 1/4 - 11	41,91	39,5	170	30	32	2400114	309,07	394,11	435,91
G 1" 3/8 - 11	44,32	42	180	32	36	2901308	377,82	469,73	511,51
G 1" 1/2 - 11	47,80	45	190	32	36	2901102	412,90	517,77	566,89
G 1" 3/4 - 11	53,75	51	190	32	40	3201304	551,74	680,81	732,52
G 2" - 11	59,61	57	220	40	45	3500200	616,79	762,70	821,81

G 551

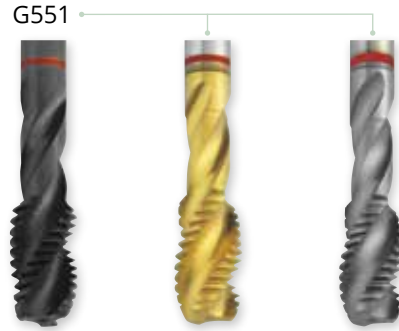
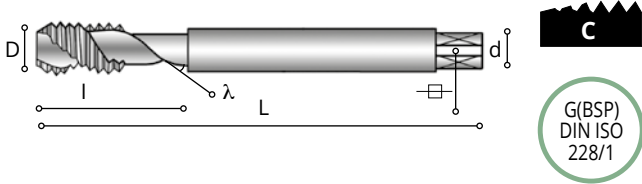

D	D (mm)		L	I	d		CODE	HSS-EX 5551..... €	HSS-EX 6551..... € QUARTZ	HSS-EX 7551..... € TITANITE
G 1/8 - 28	9,73	8,8	90	10	7	5,500108	47,33	56,79	60,48
G 1/4 - 19	13,16	11,8	100	14	11	900104	85,21	98,85	102,82
G 3/8 - 19	16,66	15,25	100	15	12	900308	84,19	98,74	103,48
G 1/2 - 14	20,96	19	125	17	16	1200102	112,18	132,95	140,31
G 5/8 - 14	22,91	21	125	20	18	14,500508	174,44	205,22	215,52
G 3/4 - 14	26,44	24,5	140	20	20	1600304	198,34	233,32	245,03
G 7/8 - 14	30,20	28,25	150	22	22	1800708	253,65	313,40	339,94
G 1" - 11	33,25	30,75	160	24	25	2000100	373,25	444,96	471,50

UNC 560

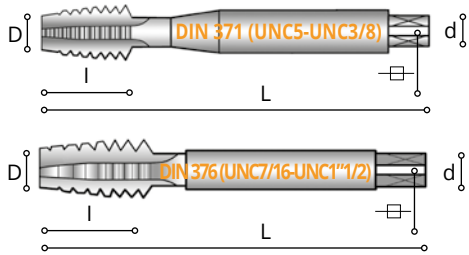

UNC560



D	D (mm)		L	I	d		CODE	HSS-EX 5560..... €	HSS-EX 6560..... € QUARTZ	HSS-EX 7560..... € TITANITE
UNC 5 - 40	3,175	2,65	56	10	3,5	2,700540	25,56	30,07	31,55
UNC 6 - 32	3,505	2,85	56	12	4	300632	24,23	28,60	30,06
UNC 8 - 32	4,166	3,5	63	12	4,5	3,400832	24,23	29,29	31,33
UNC 10 - 24	4,826	3,9	70	14	6	4,901024	26,92	32,24	34,28
UNC 12 - 24	5,486	4,5	80	18	6	4,901224	27,39	33,48	36,06
UNC 1/4 - 20	6,35	5,1	80	18	7	5,501420	28,73	35,57	38,62
UNC 5/16 - 18	7,938	6,6	90	20	8	6,201618	30,53	37,55	40,61
UNC 3/8 - 16	9,525	8	100	21	10	803816	29,43	37,10	40,78
UNC 7/16 - 14	11,11	9,4	100	20	8	6,2071614	37,75	46,26	49,94
UNC 1/2 - 13	12,7	10,8	110	24	9	701213	41,06	51,88	57,05
UNC 9/16 - 12	14,29	12,2	110	28	11	9091612	66,24	79,57	84,74
UNC 5/8 - 11	15,88	13,5	110	30	12	905811	59,62	72,30	77,47
UNC 3/4 - 10	19,05	16,5	125	32	14	1103410	80,85	98,65	106,17
UNC 7/8 - 9	22,23	19,5	140	32	18	14,507809	100,27	123,90	134,41
UNC 1" - 8	25,4	22,25	160	36	20	1601008	133,57	177,88	201,74
UNC 1" 1/8 - 7	28,58	25	180	40	22	1811807	182,89	232,13	255,98
UNC 1" 1/4 - 7	31,75	28	180	40	22	1811407	221,05	277,54	304,08
UNC 1" 3/8 - 6	34,93	30,75	200	45	28	2213806	258,65	324,08	354,64
UNC 1" 1/2 - 6	38,1	34	200	45	28	2211206	323,87	402,68	438,52

UNC 561

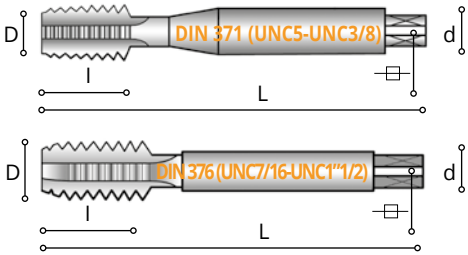

UNC561



D	D (mm)		L	l	d		CODE	HSS-EX 5561..... €	HSS-EX 6561..... € QUARTZ	HSS-EX 7561..... € TITANITE
UNC 5 - 40	3,175	2,65	56	10	3,5	2,700540	21,57	25,67	27,13
UNC 6 - 32	3,505	2,85	56	12	4	300632	27,62	32,32	33,79
UNC 8 - 32	4,166	3,5	63	12	4,5	3,400832	19,99	24,62	26,65
UNC 10 - 24	4,826	3,9	70	14	6	4,901024	21,64	26,43	28,48
UNC 12 - 24	5,486	4,5	80	18	6	4,901224	22,11	27,68	30,25
UNC 1/4 - 20	6,35	5,1	80	18	7	5,501420	22,42	28,64	31,70
UNC5/16 - 18	7,938	6,6	90	20	8	6,251618	24,08	30,47	33,52
UNC 3/8 - 16	9,525	8	100	21	10	803816	28,49	36,06	39,74
UNC 7/16 - 14	11,11	9,4	100	20	8	6,271614	37,13	45,57	49,26
UNC 1/2 - 13	12,7	10,8	110	24	9	701213	37,75	48,25	53,42
UNC 9/16 - 12	14,29	12,2	110	28	11	991612	43,04	54,05	59,22
UNC 5/8 - 11	15,88	13,5	110	30	12	905811	54,29	66,42	71,60
UNC 3/4 - 10	19,05	16,5	125	32	14	1103410	77,31	94,79	102,30
UNC 7/8 - 9	22,23	19,5	140	32	18	14,507809	95,07	118,22	128,70
UNC 1" - 8	25,4	22,25	160	36	20	1601008	127,28	170,96	194,81
UNC 1" 1/8 - 7	28,58	25	180	40	22	1811807	174,25	222,62	246,47
UNC 1" 1/4 - 7	31,75	28	180	40	22	1811407	209,02	264,31	290,84
UNC 1" 3/8 - 6	34,93	30,75	200	45	28	2213806	288,78	357,23	387,77
UNC 1" 1/2 - 6	38,1	34	200	45	28	2211206	314,70	392,59	428,42

UNC 559

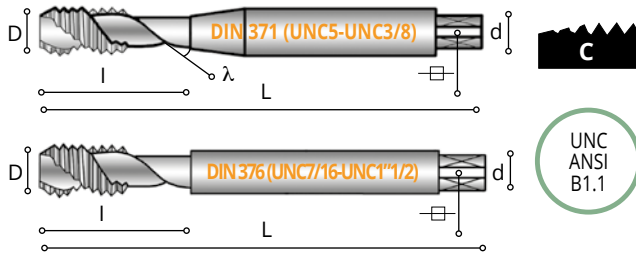

UNC559

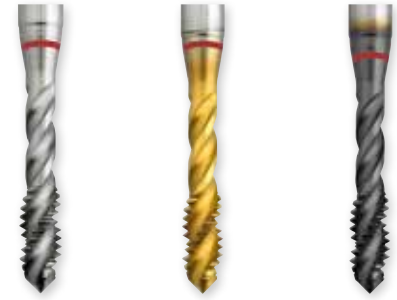

D	D (mm)		L	l	d		CODE	HSS-E 5559..... €	HSS-E 6559..... € QUARTZ	HSS-E 7559..... € TITANITE
UNC 5 - 40	3,175	2,65	56	5	3,5	2,700540	30,68	36,09	37,86
UNC 6 - 32	3,505	2,85	56	6	4	300632	29,08	34,32	36,08
UNC 8 - 32	4,166	3,5	63	7	4,5	3,400832	29,08	35,15	37,59
UNC 10 - 24	4,826	3,9	70	8	6	4,901024	31,33	37,53	39,90
UNC 12 - 24	5,486	4,5	80	10	6	4,901224	31,88	38,97	41,97
UNC 1/4 - 20	6,35	5,1	80	12	7	5,501420	33,45	41,41	44,96
UNC 5/16 - 18	7,938	6,6	90	15	8	6,201618	35,53	43,71	47,27
UNC 3/8 - 16	9,525	8	100	18	10	803816	35,31	44,52	48,93
UNC 7/16 - 14	11,112	9,4	100	15	8	6,2071614	47,90	58,69	63,37
UNC 1/2 - 13	12,7	10,8	110	18	9	701213	51,33	64,85	71,31
UNC 9/16 - 12	14,288	12,2	110	20	11	9091612	79,49	95,49	101,69
UNC 5/8 - 11	15,875	13,5	110	20	12	905811	71,54	86,76	92,97
UNC 3/4 - 10	19,05	16,5	125	25	14	1103410	95,11	116,07	124,91
UNC 7/8 - 9	22,225	19,5	140	30	18	14,507809	132,35	163,55	177,42
UNC 1" - 8	25,4	22,25	160	30	20	1601008	155,48	207,06	234,83
UNC 1" 1/8 - 7	28,575	25	180	40	22	1811807	219,46	278,56	307,18
UNC 1" 1/4 - 7	31,75	28	180	37	22	1811407	265,25	333,05	364,90
UNC 1" 3/8 - 6	34,925	30,75	200	40	28	2213806	319,69	400,57	438,34
UNC 1" 1/2 - 6	38,1	34	200	55	28	2211206	470,94	585,53	637,66

UNF 562

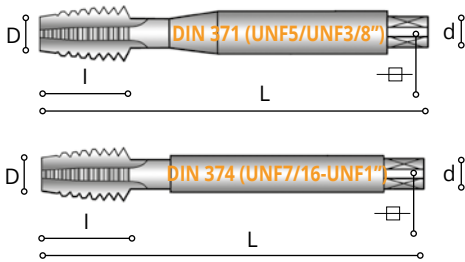

UNF562



D	D (mm)		L	I	d		CODE	HSS-EX 5562..... €	HSS-EX 6562..... € QUARTZ	HSS-EX 7562..... € TITANITE
UNF 5 - 44	3,175	2,7	56	10	3,5	2,700544	28,34	33,11	34,57
UNF 6 - 40	3,505	2,95	56	12	4	300640	28,34	33,11	34,57
UNF 8 - 36	4,166	3,5	63	12	4,5	3,400836	28,34	33,80	35,84
UNF 10 - 32	4,826	4,1	70	14	6	4,901032	28,81	34,31	36,34
UNF 12 - 28	5,486	4,7	80	18	6	4,901228	31,00	37,44	39,91
UNF 1/4 - 28	6,35	5,5	80	18	7	5,501428	31,00	38,07	41,12
UNF 5/16 - 24	7,938	6,9	90	20	8	6,251624	32,34	39,55	42,60
UNF 3/8 - 24	9,525	8,5	100	21	10	803824	36,19	44,54	48,21
UNF 7/16 - 20	11,11	9,9	100	20	8	6,271620	44,07	53,20	56,88
UNF 1/2 - 20	12,7	11,5	100	20	9	701220	44,07	53,59	57,56
UNF 9/16 - 18	14,29	12,9	100	20	11	991618	68,28	80,22	84,21
UNF 5/8 - 18	15,88	14,5	100	20	12	905818	62,94	74,35	78,33
UNF 3/4 - 16	19,05	17,5	110	24	14	1103416	89,76	108,27	115,63
UNF 7/8 - 14	22,23	20,4	125	24	18	14,507814	104,94	128,79	139,07
UNF 1" - 12	25,4	23,25	140	27	18	14,501012	134,12	162,68	174,37

UNF 563

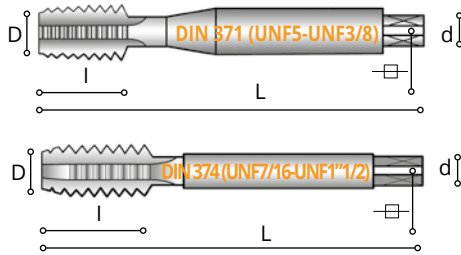

UNF563



D	D (mm)		L	l	d		CODE	HSS-EX 5563..... €	HSS-EX 6563..... € QUARTZ	HSS-EX 7563..... € TITANITE
UNF 5 - 44	3,175	2,7	56	10	3,5	2,700544	24,87	29,26	30,68
UNF 6 - 40	3,505	2,95	56	12	4	300640	23,75	28,01	29,42
UNF 8 - 36	4,166	3,5	63	12	4,5	3,400836	23,75	28,67	30,65
UNF 10 - 32	4,826	4,1	70	14	6	4,901032	24,87	29,91	31,89
UNF 12 - 28	5,486	4,7	80	18	6	4,901228	27,64	33,64	36,14
UNF 1/4 - 28	6,35	5,5	80	18	7	5,501428	28,49	35,31	38,36
UNF 5/16 - 24	7,938	6,9	90	20	8	6,251624	29,82	36,78	39,84
UNF 3/8 - 24	9,525	8,5	100	21	10	803824	34,18	42,19	45,76
UNF 7/16 - 20	11,11	9,9	100	20	8	6,271620	45,31	54,57	58,26
UNF 1/2 - 20	12,7	11,5	100	20	9	701220	43,95	53,32	57,18
UNF 9/16 - 18	14,29	12,9	100	20	11	991618	79,53	92,60	96,58
UNF 5/8 - 18	15,88	14,5	100	20	12	905818	66,39	78,00	81,86
UNF 3/4 - 16	19,05	17,5	110	24	14	1103416	92,19	110,97	118,33
UNF 7/8 - 14	22,23	20,4	125	24	18	14,507814	112,89	137,53	147,82
UNF 1" - 12	25,4	23,25	140	27	18	14,501012	148,80	178,36	189,71
UNF 1" 1/8 - 12	28,58	26,5	150	28	22	1811812	185,98	235,51	259,36
UNF 1" 1/4 - 12	31,75	29,5	150	28	22	1811412	216,25	272,26	298,80
UNF 1" 3/8 - 12	34,93	32,75	170	28	28	2213812	321,89	388,47	415,01
UNF 1" 1/2 - 12	38,1	36	170	30	32	2411212	369,57	446,05	476,55

UNF 564

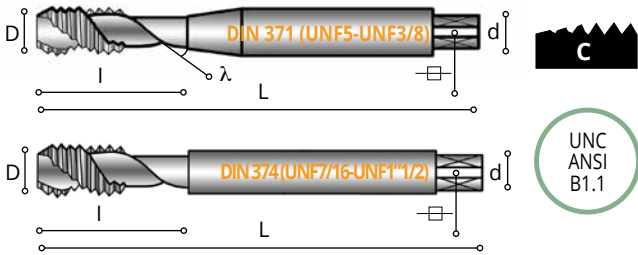

UNF564

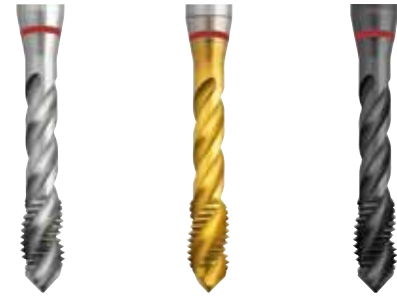

D	D (mm)		L	I	d		CODE	HSS-E 5564..... €	HSS-E 6564..... € QUARTZ	HSS-E 7564..... € TITANITE
UNF 5 - 44	3,175	2,7	56	5	3,5	2,700544	34,00	39,73	41,49
UNF 6 - 40	3,505	2,95	56	6	4	300640	34,00	39,73	41,49
UNF 8 - 36	4,166	3,5	63	7	4,5	3,400836	34,00	40,56	43,01
UNF 10 - 32	4,826	4,1	70	8	6	4,901032	34,57	41,17	43,61
UNF 12 - 28	5,486	4,7	80	10	6	4,901228	37,20	44,93	48,02
UNF 1/4 - 28	6,35	5,5	80	12	7	5,501428	37,20	45,69	49,34
UNF 5/16 - 24	7,938	6,9	90	15	8	6,251624	38,81	47,45	51,12
UNF 3/8 - 24	9,525	8,5	100	18	10	803824	43,43	53,45	57,86
UNF 7/16 - 20	11,112	9,9	100	15	8	6,271620	56,64	68,21	72,82
UNF 1/2 - 20	12,7	11,5	100	15	9	701220	56,64	68,71	73,69
UNF 9/16 - 18	14,288	13	100	15	11	991618	95,44	111,12	115,90
UNF 5/8 - 18	15,875	14,5	100	15	12	905818	82,13	96,49	101,27
UNF 3/4 - 16	19,05	17,5	110	17	14	1103416	110,63	133,16	141,99
UNF 7/8 - 14	22,225	20,5	125	17	18	14,507814	152,00	185,17	199,02
UNF 1" - 12	25,4	23,3	140	20	18	14,501012	184,07	220,65	234,70
UNF 1" 1/8 - 12	28,575	26,5	150	22	22	1811812	227,63	288,26	317,45
UNF 1" 1/4 - 12	31,75	29,5	150	22	22	1811412	259,50	326,71	358,56
UNF 1" 3/8 - 12	34,925	32,8	170	22	28	2213812	392,06	473,15	505,48
UNF 1" 1/2 - 12	38,1	36	170	24	32	2411212	548,14	661,58	706,83

W 580

DIN
371DIN
376 λ
0°

55°

Medium

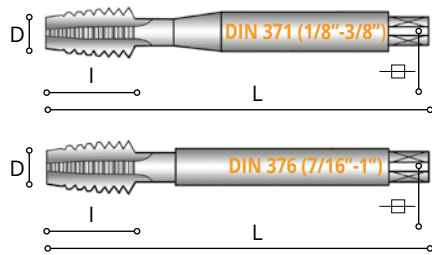

d



d

BSW
BS84:1956

W580



D	D (mm)		L	I	d		CODE	HSS-EX 5580..... €
W 1/8-40	3,175	2,5	56	10	3,5	2,700108	23,12
W 3/16-24	4,762	3,6	70	14	6	4,900316	23,46
W 1/4-20	6,35	5,1	80	18	7	5,500104	24,75
W 5/16-18	7,938	6,5	90	20	8	6,200516	26,80
W 3/8-16	9,525	7,9	100	21	10	800308	30,39
W 7/16-14	11,11	9,25	100	20	8	6,200716	42,99
W 1/2-12	12,7	10,5	110	24	9	700102	43,80
W 5/8-11	15,88	13,5	110	30	12	900508	60,07
W 3/4-10	19,05	16,5	125	32	14	1100304	84,90
W 7/8-9	22,23	19,25	140	32	18	14,500708	119,48
W 1"-8	25,4	22	160	36	20	1600100	122,01

W 581

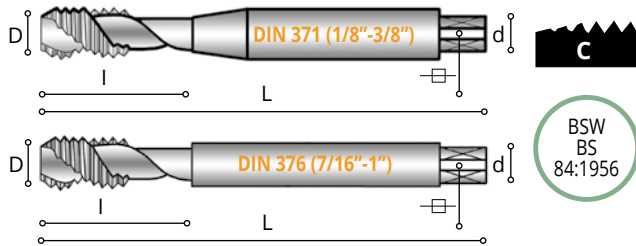

W581



D	D (mm)		L	I	d		CODE	HSS-EX 5581..... €
W 1/8-40	3,175	2,5	56	5	3,5	2,700108	25,40
W 3/16-24	4,762	3,6	70	8	6	4,900316	25,81
W 1/4-20	6,35	5,1	80	12	7	5,500104	27,20
W 5/16-18	7,938	6,5	90	15	8	6,200516	29,48
W 3/8-16	9,525	7,9	100	18	10	800308	34,06
W 7/16-14	11,11	9,25	100	15	8	6,200716	48,05
W 1/2-12	12,7	10,5	110	18	9	700102	48,05
W 5/8-11	15,88	13,5	110	20	12	900508	64,86
W 3/4-10	19,05	16,5	125	25	14	1100304	99,99
W 7/8-9	22,23	19,25	140	25	18	14,500708	137,08
W 1"-8	25,4	22	160	30	20	1600100	132,98

NPT 590

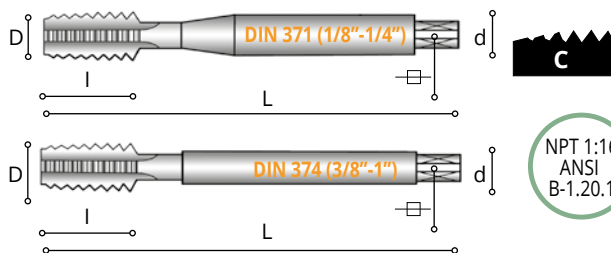

NPT 590



D		L	I	d		CODE	HSS-EX 5590..... €
NPT 1/8-27	8,5	90	12	7	5,500108	71,08
NPT 1/4-18	11,1	100	18	11	900104	85,90
NPT 3/8-18	14,7	110	18	14	1100308	93,92
NPT 1/2-14	18	140	23	18	14,500102	124,81
NPT 3/4-14	23,25	140	24	20	1600304	177,34
NPT 1"-11,1/2	29,25	160	30	25	2000100	370,72

M 531

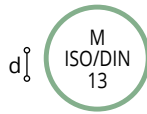
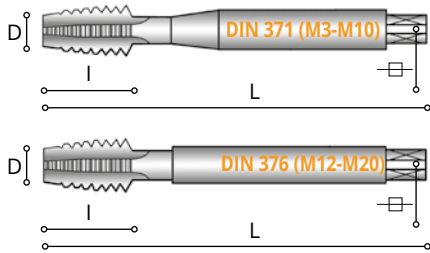

M531



D		L	I	d		CODE	HSS-E 5531..... €
M 3 x 0,5	2,5	56	10	3,5	2,700003	15,99
M 4 x 0,7	3,3	63	12	4,5	3,400004	16,24
M 5 x 0,8	4,2	70	14	6	4,900005	17,18
M 6 x 1	5	80	18	6	4,900006	17,18
M 8 x 1,25	6,8	90	20	8	6,200008	19,95
M 10 x 1,5	8,5	100	20	10	800010	25,54
M 12 x 1,75	10,2	110	29	9	700012	36,23
M 14 X 2	12	110	30	11	900014	49,50
M 16 x 2	14	110	32	12	900016	52,92
M 20 X 2.5	17,5	140	34	16	1200020	76,98

M 532

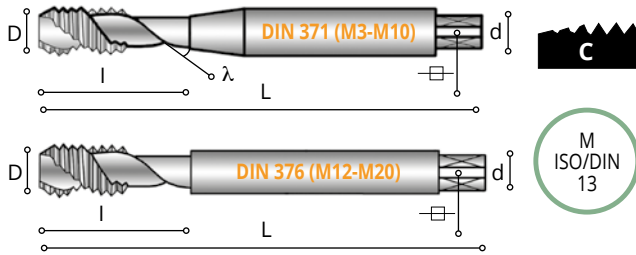

M 532



D		L	l	d		CODE	HSS-E 5532..... €
M 3 x 0,5	2,5	56	5	3,5	2,7	...00003	17,57
M 4 x 0,7	3,3	63	7	4,5	3,4	...00004	17,92
M 5 x 0,8	4,2	70	8	6	4,9	...00005	18,86
M 6 x 1	5	80	10	6	4,9	...00006	18,86
M 8 x 1,25	6,8	90	13	8	6,2	...00008	21,93
M 10 x 1,5	8,5	100	15	10	8	...00010	28,17
M 12 x 1,75	10,2	110	18	9	7	...00012	39,85
M 14 x 2	12	110	20	11	9	...00014	54,45
M 16 x 2	14	110	20	12	9	...00016	58,26
M 20 x 2,5	17,5	140	25	16	12	...00020	84,69

MASCHI A MACCHINA LUNGHİ PER FORO PASSANTE | LONG SERIES MACHINE TAPS FOR THROUGH HOLES

M 546

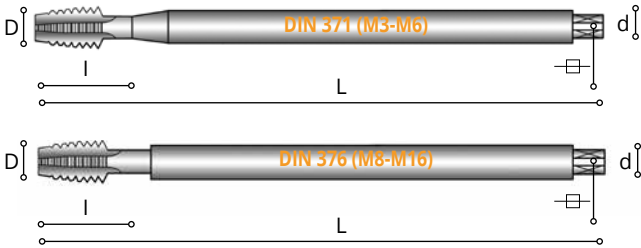

M546



D		L	I	d		CODE	HSS-E 5546..... €	HSS-E 6546..... € QUARTZ	HSS-E 7546..... € TITANITE
M 3 X0,5	2,5	100	10	3,5	2,700003	33,63	41,00	45,26
M 4 x 0,7	3,3	125	12	4,5	3,400004	34,23	42,89	47,31
M 5 x 0,8	4,2	140	14	6	4,900005	36,06	44,92	49,50
M 6 x 1	5	160	18	6	4,900006	36,06	46,35	52,05
M 8 x 1,25	6,8	180	20	6	4,900008	47,58	62,49	70,36
M 10 x 1,5	8,5	200	22	7	5,500010	59,09	76,24	85,09
M 12 x 1,75	10,2	220	29	9	700012	76,16	89,87	97,06
M 14 x 2	12	220	30	11	900014	104,08	117,61	130,07
M 16 x 2	14	220	32	12	900016	111,31	125,78	139,11

M 545

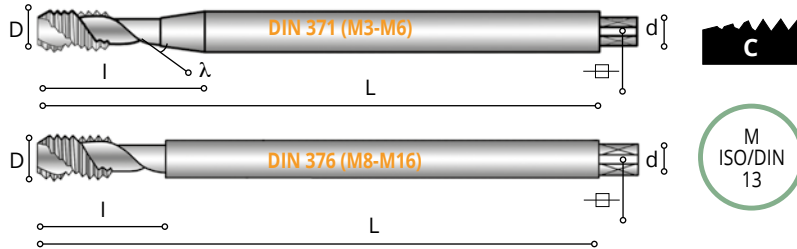

D		L	I	d		CODE	HSS-E 5545..... €	HSS-E 6545..... € QUARTZ	HSS-E 7545..... € TITANITE
M 3 X 0,5	2,5	100	5	3,5	2,700003	36,95	45,04	49,72
M 4 x 0,7	3,3	125	7	4,5	3,400004	37,69	47,23	52,10
M 5 x 0,8	4,2	140	8	6	4,900005	39,67	49,41	54,45
M 6 x 1	5	160	10	6	4,900006	39,67	50,98	57,25
M 8 x 1,25	6,8	180	13	6	4,900008	53,05	69,68	78,46
M 10 x 1,5	8,5	200	15	7	5,500010	65,04	83,92	93,66
M 12 x 1,75	10,2	220	18	9	700012	83,86	98,95	106,87
M 14 x 2	12	220	20	11	900014	114,49	129,37	143,08
M 16 x 2	14	220	20	12	900016	122,52	138,45	153,13

PG 591

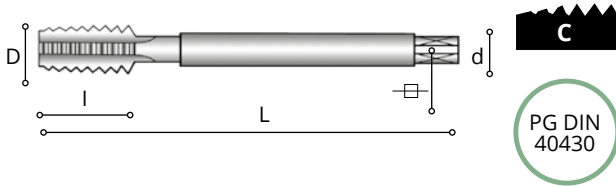

PG591



D	D (mm)		L	I	d		CODE	HSS-E 5591..... €
PG 7 - 20	12,50	11,4	70	22	9	700007	55,91
PG 9 - 18	15,20	14	70	22	12	900009	62,20
PG 11 - 18	18,60	17,25	80	22	14	1100011	69,33
PG 13,5 - 18	20,40	19	80	22	16	1200135	85,31
PG 16 - 18	22,50	21,25	80	22	18	14,500016	98,67
PG 21 - 16	28,30	27	90	22	22	1800021	122,52
PG 29 - 16	37	35,5	100	25	28	2200029	185,05

PM 700

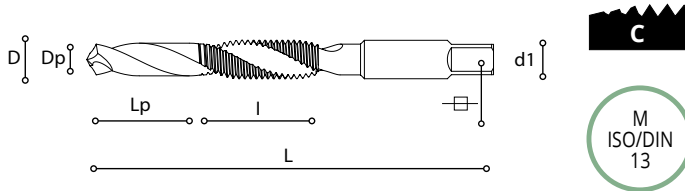

PM700



D	Dp	Lp	L	I	d1		CODE	HSS 5700..... €	HSS 6700..... € QUARTZ
M 3x0,5	2,5	16	56	11	3	2,400003	38,08	44,59
M 4x0,7	3,3	18	63	14	4	300004	38,08	44,59
M 5x0,8	4,2	20	71	18	5	3,800005	38,90	46,53
M 6x1	5	22	80	22	6	4,900006	43,30	51,19
M 8x1,25	6,8	26	95	25	8	6,200008	44,08	52,36
M 10x1,5	8,5	30	106	31	10	800010	58,98	70,38
M 12x1,75	10,2	32	115	35	12	900012	64,73	76,98

MF 548
INOX

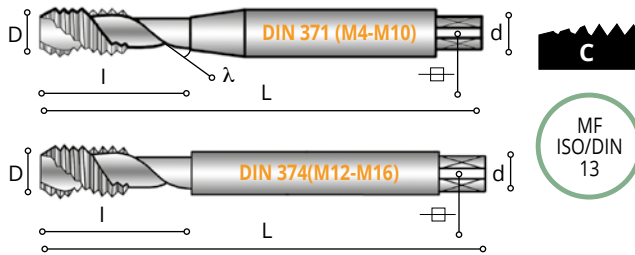

D		L	I	d		CODE	HSS-E 5548..... €	HSS-E 6548..... € QUARTZ
MF 4 x 0,5	3,5	63	7	4,5	3,400004	27,90	33,83
MF 5 x 0,5	4,5	70	8	6	4,900005	39,15	47,36
MF 6 x 0,5	5,5	80	10	6	4,905006	29,40	36,27
MF 6 x 0,75	5,3	80	10	6	4,907506	27,36	33,76
MF 8 x 0,75	7,3	80	10	8	6,207508	31,84	39,53
MF 8 x 1	7	90	13	8	6,210008	29,60	36,75
MF 10 x 0,75	9,2	90	13	10	807510	43,68	53,93
MF 10 x 1	9	90	13	10	810010	34,95	43,16
MF 10 x 1,25	8,8	100	15	10	812510	40,77	50,34
MF 12 x 1	11	100	10	9	710012	49,58	61,03
MF 12 x 1,25	10,8	100	15	9	712512	53,72	66,13
MF 12 x 1,5	10,5	100	15	9	715012	49,58	61,03
MF 14 X 1	13	100	15	11	910014	67,80	82,04
MF 14 X 1,5	12,5	100	15	11	915014	67,80	82,04
MF 16 x 1	15	100	15	12	910016	78,43	94,21
MF 16 x 1,5	14,5	100	15	12	915016	69,42	83,39

G 553
INOX

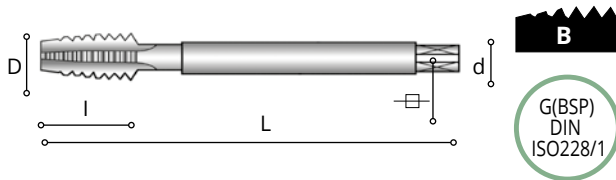

D	D (mm)		L	I	d		CODE	HSS-E 5553..... €	HSS-E 6553..... € QUARTZ
G 1/8"-28	9,73	8,8	90	18	7	5,500108	39,60	48,59
G 1/4"-19	13,16	11,8	100	22	11	900104	71,07	85,65
G 3/8"-19	16,66	15,25	100	22	12	900308	70,22	83,94
G 1/2"-14	20,96	19	125	25	16	1200102	93,72	113,74
G 5/8"-14	22,91	21	125	25	18	14,500508	145,62	178,86
G 3/4"-14	26,44	24,5	140	28	20	1600304	165,63	200,78
G 7/8"-14	30,20	28,25	150	28	22	1800708	211,78	274,62
G 1"-11	33,25	30,75	160	30	25	2000100	311,52	399,02

G 552
INOX

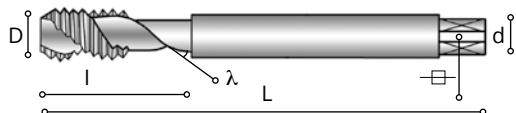

D	D (mm)		L	I	d		CODE	HSS-E 5552..... €	HSS-E 6552..... € QUARTZ
G 1/8"-28	9,73	8,8	90	10	7	5,500108	43,51	53,39
G 1/4"-19	13,16	11,8	100	14	11	900104	78,36	94,43
G 3/8"-19	16,66	15,25	100	15	12	900308	77,30	92,40
G 1/2"-14	20,96	19	125	17	16	1200102	103,12	125,14
G 5/8"-14	22,91	21	125	17	18	14,500508	161,78	198,70
G 3/4"-14	26,44	24,5	140	20	20	1600304	182,16	220,81
G 7/8"-14	30,20	28,25	150	22	22	1800708	235,11	304,88
G 1"-11	33,25	30,75	160	24	25	2000100	342,78	439,06

M 513 ALUMINUM

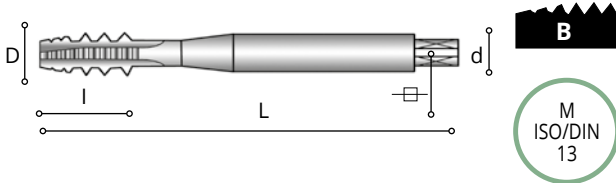

D		L	l	d		CODE	HSS-EX	HSS-EX	HSS-EX
							5513..... €	6513..... € QUARTZ	7513..... € TITANITE
M 3 x 0,5	2,5	56	10	3,5	2,700003	18,96	22,80	24,27
M 4 x 0,7	3,3	63	12	4,5	3,400004	18,96	23,49	25,53
M 5 x 0,8	4,2	70	14	6	4,900005	19,99	24,62	26,66
M 6 x 1	5	80	18	6	4,900006	19,99	25,34	27,91
M 8 x 1,25	6,8	90	20	8	6,200008	24,01	30,38	33,44
M 10 x 1,5	8,5	100	20	10	800010	30,68	38,47	42,15

M 544
SOFT
ALUMINUM

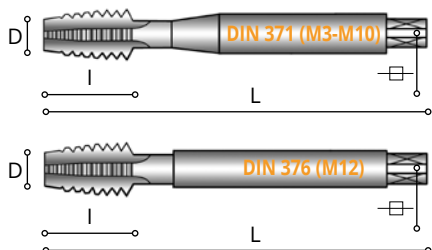

M544



D		L	l	d		CODE	HSS-E 5544..... €
M 3 x 0,5	2,5	56	10	3,5	2,7	...00003	17,16
M 4 x 0,7	3,3	63	12	4,5	3,4	...00004	17,45
M 5 x 0,8	4,2	70	14	6	4,9	...00005	18,42
M 6 x 1	5	80	18	6	4,9	...00006	18,42
M 8 x 1,25	6,8	90	20	8	6,2	...00008	21,41
M 10 x 1,5	8,5	100	20	10	8	...00010	27,56
M 12 x 1,75	10,2	110	29	9	7	...00012	38,87

M 541
ALU

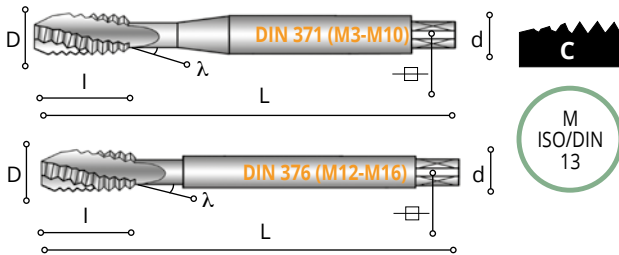

M541



D		L	I	d		CODE	HSS-E 7541..... € TITANITE
M 3 x 0,5	2,5	56	11	3,5	2,700003	22,29
M 4 x 0,7	3,3	63	13	4,5	3,400004	22,63
M 5 x 0,8	4,2	70	15	6	4,900005	24,45
M 6 x 1	5	80	17	6	4,900006	25,28
M 8 x 1,25	6,8	90	20	8	6,200008	30,14
M 10 x 1,5	8,5	100	20	10	800010	41,60
M 12 x 1,75	10,2	110	29	9	700012	55,14
M 16 x 2	14	110	32	12	900016	80,18

M 542
ALU

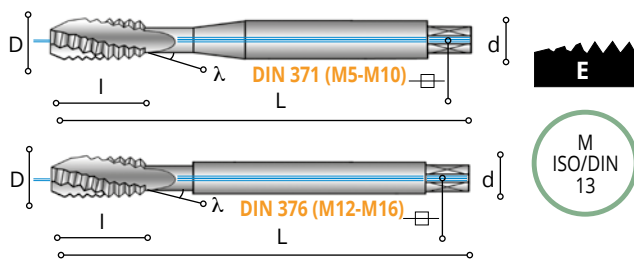

M542



D		L	l	d		CODE	RESISTOR 8542..... € OPAL
M 5 x 0,8	4,2	70	15	6	4,9	...50030	36,68
M 6 x 1	5	80	17	6	4,9	...60030	37,92
M 8 x 1,25	6,8	90	20	8	6,2	...80030	45,23
M 10 x 1,5	8,5	100	20	10	8	...10030	62,39
M 12 x 1,75	10,2	110	29	9	7	...12030	82,70
M 16 x 2	14	110	32	12	9	...16030	104,16

M 515
ALU

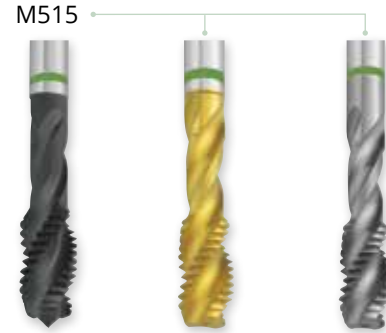
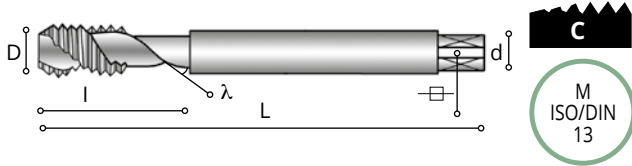

D		L	I	d		CODE	HSS-EX 5515..... €	HSS-EX 6515..... € QUARTZ	HSS-EX 7515..... € TITANITE
M 3 x 0,5	2,5	56	5	2,2	-00003	18,49	22,29	23,75
M 4 x 0,7	3,3	63	7	2,8	2,100004	18,49	22,29	23,75
M 5 x 0,8	4,2	70	8	3,5	2,700005	19,43	24,01	26,04
M 6 x 1	5	80	10	4,5	3,400006	19,43	24,74	27,31
M 8 x 1,25	6,8	90	13	6	4,900008	24,24	30,64	33,68
M 10 x 1,5	8,5	100	15	7	5,500010	30,52	38,31	41,98
M 12 x 1,75	10,2	110	18	9	700012	34,38	43,89	48,59
M 14 x 2	12	110	20	11	900014	47,45	58,89	64,07
M 16 x 2	14	110	20	12	900016	54,44	66,59	71,76

M 543
ALU

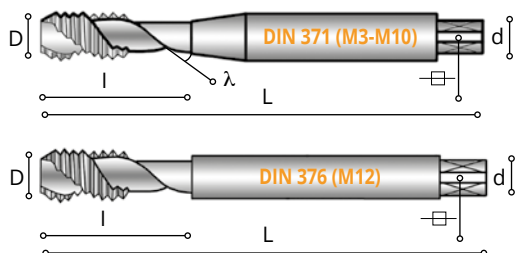

M543



D		L	l	d		CODE	HSS-E 5543..... €
M 3 X0,5	2,5	56	5	3,5	2,700003	20,29
M 4 x 0,7	3,3	63	7	4,5	3,400004	20,67
M 5 x 0,8	4,2	70	8	6	4,900005	21,75
M 6 x 1	5	80	10	6	4,900006	21,75
M 8 x 1,25	6,8	90	13	8	6,200008	25,37
M 10 x 1,5	8,5	100	15	10	800010	32,37
M 12 x 1,75	10,2	110	18	9	700012	45,96

M 524 GHISA CAST IRON

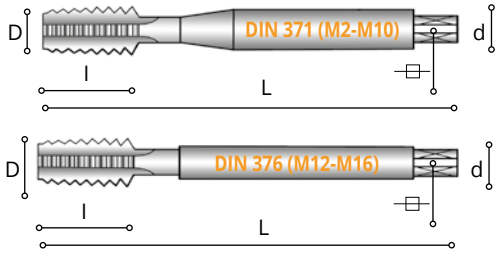

M524



D		L	I	d		CODE	RESISTOR 5524..... € OPAL
M 3	2,5	56	10	3,5	2,700003	20,80
M 4	3,3	63	12	4,5	3,400004	23,81
M 5	4,2	70	14	6	4,900005	22,29
M 6	5	80	18	6	4,900006	23,66
M 8	6,8	90	20	8	6,200008	31,98
M 10	8,5	100	20	10	800010	40,71
M 12	10,2	110	28	9	700012	55,04
M 16	14	110	32	12	900016	75,61

M 525
GHISA
CAST IRON

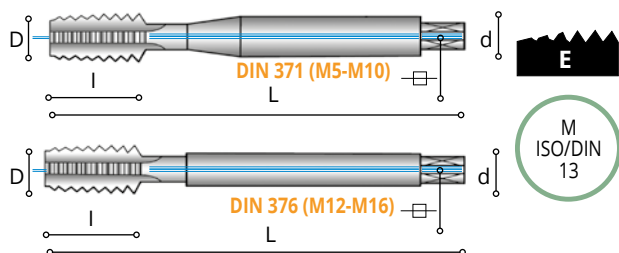

M525



D		L	l	d		CODE	RESISTOR 8525..... € OPAL
M 5 x 0,8	4,2	70	14	6	4,9	...50030	28,86
M 6 x 1	5	80	18	6	4,9	...60030	29,95
M 8 x 1,25	6,8	90	20	8	6,2	...80030	36,18
M 10 x 1,5	8,5	100	20	10	8	...10030	47,77
M 12 x 1,75	10,2	110	29	9	7	...12030	66,08
M 16 x 2	14	110	32	12	9	...16030	94,83

M 526 GHISA CAST IRON

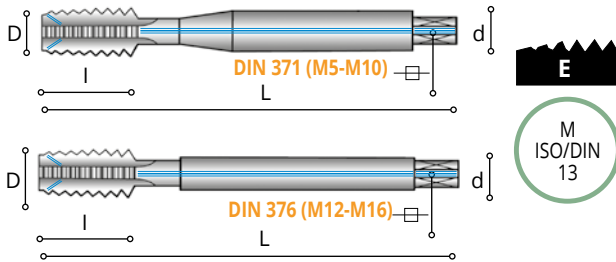

M526



D		L	I	d		CODE	RESISTOR 8526..... € OPAL
M 5 x 0,8	4,2	70	14	6	4,950030	32,67
M 6 x 1	5	80	18	6	4,960030	33,96
M 8 x 1,25	6,8	90	20	8	6,280030	40,99
M 10 x 1,5	8,5	100	20	10	810030	54,15
M 12 X 1,75	10,2	110	29	9	712030	74,89
M 16 x 2	14	110	32	12	916030	108,47

M 533

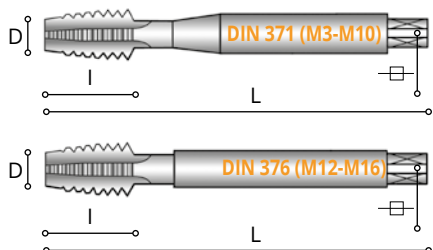
MASCHIATURA RIGIDA
RIGID TAPPING

M533



D		L	I	d		CODE	RESISTOR 8533..... € OPAL
M 3 x 0,5	2,5	56	5	3,5	2,7	...30030	23,28
M 4 x 0,7	3,3	63	7	4,5	3,4	...40030	23,61
M 5 x 0,8	4,2	70	8	6	4,9	...50030	25,53
M 6 x 1	5	80	10	6	4,9	...60030	26,30
M 8 x 1,25	6,8	90	13	8	6,2	...80030	31,57
M 10 x 1,5	8,5	100	15	10	8	...10030	41,46
M 12 x 1,75	10,2	110	18	9	7	...12030	57,66
M 14 x 2	12	110	20	11	9	...14030	90,19
M 16 x 2	14	110	20	12	9	...16030	82,64
M 18 x 2,5	15,5	125	25	14	11	...18030	127,98
M 20 x 2,5	17,5	140	25	16	12	...20030	138,84

M 527
MASCHIATURA RIGIDA
RIGID TAPPING

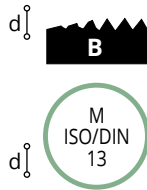
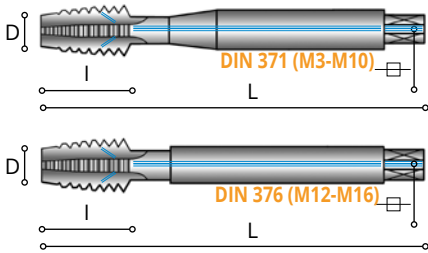

M527



D		L	I	d		CODE	RESISTOR 8527..... € OPAL
M 5 x 0,8	4,2	70	8	6	4,950030	41,98
M 6 x 1	5	80	10	6	4,960030	43,29
M 8 x 1,25	6,8	90	13	8	6,280030	51,94
M 10 x 1,5	8,5	100	15	10	810030	68,16
M 12 x 1,75	10,2	110	18	9	712030	94,83
M 16 x 2	14	110	20	12	916030	136,04

M 534

MASCHIATURA RIGIDA
RIGID TAPPING

DIN
371DIN
376 λ
45° λ
60°

6H

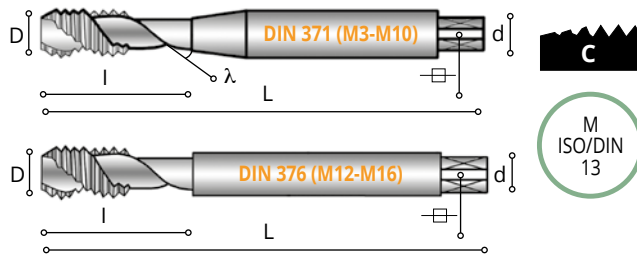

M534



D		L	l	d		CODE	RESISTOR 8534..... € OPAL
M 3 x 0,5	2,5	56	5	3,5	2,7	...30030	25,75
M 4 x 0,7	3,3	63	7	4,5	3,4	...40030	26,91
M 5 x 0,8	4,2	70	8	6	4,9	...50030	28,97
M 6 x 1	5	80	10	6	4,9	...60030	28,55
M 8 x 1,25	6,8	90	13	8	6,2	...80030	33,99
M 10 x 1,5	8,5	100	15	10	8	...10030	45,66
M 12 x 1,75	10,2	110	18	9	7	...12030	62,19
M 14 x 2	12	110	20	11	9	...14030	96,92
M 16 x 2	14	110	20	12	9	...16030	89,23
M 18 x 2,5	15,5	125	25	14	11	...18030	137,64
M 20 x 2,5	17,5	140	25	16	12	...20030	148,99

M 528
MASCHIATURA RIGIDA
RIGID TAPPING

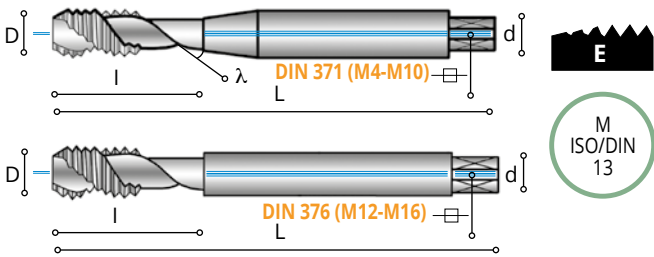

M528

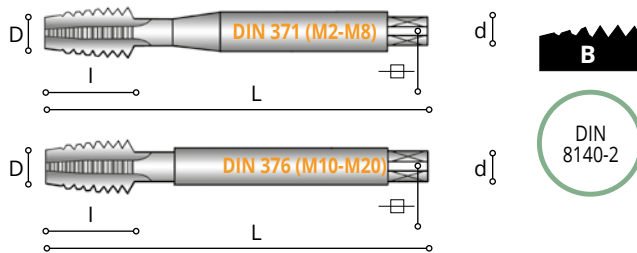
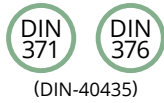

D		L	I	d		CODE	RESISTOR 8528..... € OPAL
M 5 x 0,8	4,2	70	8	6	4,950030	44,32
M 6 x 1	5	80	10	6	4,960030	45,69
M 8 x 1,25	6,8	90	13	8	6,280030	54,49
M 10 x 1,5	8,5	100	15	10	810030	71,30
M 12 x 1,75	10,2	110	18	9	712030	99,54
M 16 x 2	14	110	20	12	916030	142,86

EG-M 549
MASCHIATURA RIGIDA
RIGID TAPPING

EG-M549



D		L	l	d		CODE	RESISTOR 8549..... € OPAL
EG-M 2 x 0,4	2,10	50	9	2,8	2,1	...00002	69,44
EG-M 2,5 x 0,45	2,65	56	10	3,5	2,7	...00025	69,44
EG-M 3 x 0,5	3,15	63	12	4,5	3,4	...00003	53,79
EG-M 4 x 0,7	4,20	70	14	6	4,9	...00004	56,09
EG-M 5 x 0,8	5,25	80	18	6	4,9	...00005	60,41
EG-M 6 x 1	6,30	90	18	8	6,2	...00006	62,01
EG-M 8 x 1,25	8,40	100	20	10	8	...00008	80,28
EG-M 10 x 1,50	10,50	100	15	9	7	...00010	116,46
EG-M 12 x 1,75	12,50	110	20	11	9	...00012	148,19
EG-M 14 x 2	14,50	110	20	12	9	...00014	188,74
EG-M 16 x 2	16,50	125	20	14	11	...00016	202,04
EG-M 18 x 2,5	18,75	140	27	18	14,5	...00018	253,92
EG-M 20 x 2,5	20,75	160	30	18	14,5	...00020	279,09

EG-M 529
 MASCHIATURA RIGIDA
 RIGID TAPPING

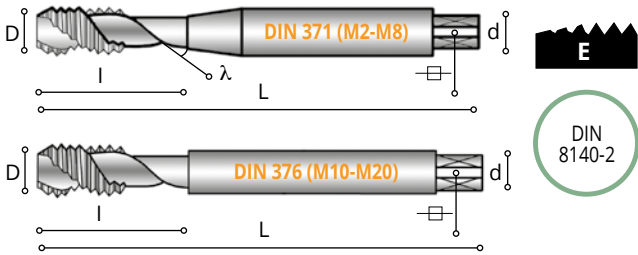

EG-M529



D		L	I	d		CODE	RESISTOR 8529..... € OPAL
EG-M 2 x 0,4	2,10	50	5	2,8	2,100002	77,43
EG-M 2,5 x 0,45	2,65	56	5	3,5	2,700025	77,43
EG-M 3 x 0,5	3,15	63	5	4,5	3,400003	59,97
EG-M 4 x 0,7	4,20	70	8	6	4,900004	62,60
EG-M 5 x 0,8	5,25	80	10	6	4,900005	67,53
EG-M 6 x 1	6,30	90	10	8	6,200006	69,33
EG-M 8 x 1,25	8,40	100	16	10	800008	88,00
EG-M 10 x 1,50	10,50	100	15	9	700010	127,56
EG-M 12 x 1,75	12,50	110	20	11	900012	160,78
EG-M 14 x 2	14,50	110	20	12	900014	211,07
EG-M 16 x 2	16,50	125	20	14	1100016	226,06
EG-M 18 x 2,5	18,75	140	27	18	14,500018	276,52
EG-M 20 x 2,5	20,75	160	30	18	14,500020	334,26

G 537

MASCHIATURA RIGIDA
RIGID TAPPING

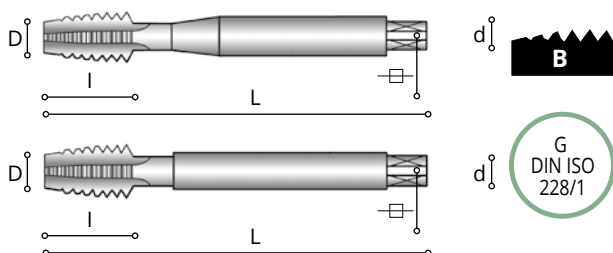

G537



D	D (mm)		L	I	d		CODE	RESISTOR 8537..... € OPAL
G 1/8 _ 28	9,728	8,8	90	10	7	5,500108	63,15
G 1/4 _ 19	13,157	11,8	100	14	11	900104	103,86
G 3/8 _ 19	16,662	15,25	100	15	12	900308	115,39
G 1/2 _ 14	20,955	19	125	17	16	1200102	141,88
G 5/8 _ 14	22,911	21	125	20	18	14,500508	214,92
G 3/4 _ 14	26,441	24,5	140	20	20	1600304	241,02
G 7/8 _ 14	30,201	28,25	150	22	22	1800708	315,87
G 1" _ 11	33,249	30,75	160	24	25	2000100	434,09

MASCHI A MACCHINA SYNCHRO PER FORI CIECHI | MACHINE SYNCHRO TAPS FOR BLIND HOLES

G 538

MASCHIATURA RIGIDA
RIGID TAPPING

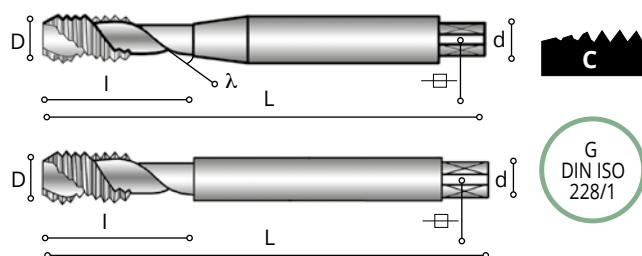

G538



D	D (mm)		L	I	d		CODE	RESISTOR 8538..... € OPAL
G 1/8 _ 28	9,728	8,8	90	10	7	5,500108	69,78
G 1/4 _ 19	13,157	11,8	100	14	11	900104	114,94
G 3/8 _ 19	16,662	15,25	100	15	12	900308	125,97
G 1/2 _ 14	20,955	19	125	17	16	1200102	155,83
G 5/8 _ 14	22,911	21	125	20	18	14,500508	235,58
G 3/4 _ 14	26,441	24,5	140	20	20	1600304	265,55
G 7/8 _ 14	30,201	28,25	150	22	22	1800708	347,85
G 1" _ 11	33,249	30,75	160	24	25	2000100	480,56

UNC 575

MASCHIATURA RIGIDA
RIGID TAPPING

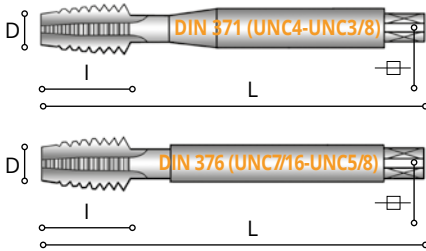

UNC575



D	D (mm)		L	I	d		CODE	RESISTOR 8575..... € OPAL
UNC 4_40	2,844	2,35	56	5	3,5	2,700440	39,85
UNC 5_40	3,175	2,65	56	7	3,5	2,700540	36,04
UNC 6_32	3,505	2,85	56	6	4	300632	36,12
UNC 8_32	4,166	3,5	63	7	4,5	3,400832	33,88
UNC 10_24	4,826	3,9	70	8	6	4,901024	37,43
UNC 12_24	5,486	4,5	80	10	6	4,901224	37,94
UNC 1/4_20	6,35	5,1	80	13	7	5,501420	32,85
UNC 5/16_18	7,938	6,6	90	13	8	651618	44,62
UNC 3/8_16	9,525	8	100	15	10	803816	61,04
UNC 7/16_14	11,112	9,4	100	15	8	6,271614	72,78
UNC 1/2_13	12,7	10,8	110	18	9	701213	102,40
UNC 9/16_12	14,288	12,2	110	20	11	991612	108,76
UNC 5/8_11	15,875	13,5	110	22	12	905811	98,56
UNC 3/4_10	19,05	16,5	125	32	14	1100304	139,50
UNC 1" _8	25,40	22,5	160	36	20	1600100	281,28

UNC 576

MASCHIATURA RIGIDA
RIGID TAPPING

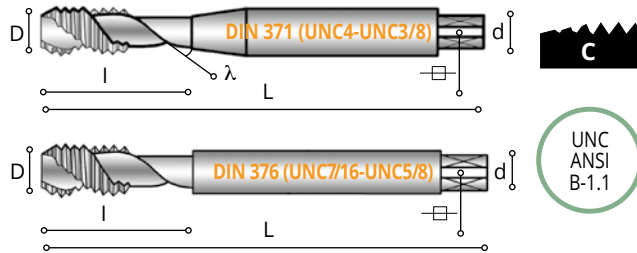

UNC576



D	D (mm)		L	l	d		CODE	RESISTOR 8576..... € OPAL
UNC 4_40	2,844	2,35	56	5	3,5	2,7	...00440	42,23
UNC 5_40	3,175	2,65	56	7	3,5	2,7	...00540	41,22
UNC 6_32	3,505	2,85	56	6	4	3	...00632	41,74
UNC 8_32	4,166	3,5	63	7	4,5	3,4	...00832	41,05
UNC 10_24	4,826	3,9	70	8	6	4,9	...01024	42,33
UNC 12_24	5,486	4,5	80	10	6	4,9	...01224	43,48
UNC 1/4_20	6,35	5,1	80	13	7	5,5	...01420	57,17
UNC 5/16_18	7,938	6,6	90	13	8	6	...51618	56,27
UNC 3/8_16	9,525	8	100	15	10	8	...03816	66,83
UNC 7/16_14	11,112	9,4	100	15	8	6,2	...71614	78,77
UNC 1/2_13	12,7	10,8	110	18	9	7	...01213	110,49
UNC 9/16_12	14,288	12,2	110	20	11	9	...91612	117,99
UNC 5/8_11	15,875	13,5	110	22	12	9	...05811	106,81
UNC 3/4_10	19,05	16,5	125	32	14	11	...00304	150,00
UNC 1"_8	25,40	22,5	160	36	20	16	...00100	303,36

UNF 565

MASCHIATURA RIGIDA
RIGID TAPPING

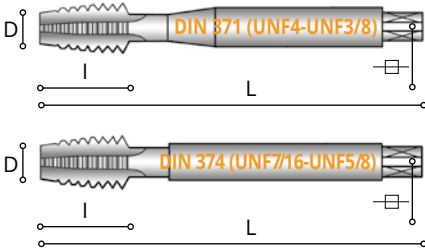

UNF565



D	D (mm)		L	I	d		CODE	RESISTOR 8565..... € OPAL
UNF 4_48	2,844	2,4	56	5	3,5	2,700448	41,79
UNF 5_44	3,175	2,7	56	7	3,5	2,700544	40,40
UNF 6_40	3,505	2,95	56	6	4	300640	40,91
UNF 8_36	4,165	3,5	63	7	4,5	3,400836	37,41
UNF 10_32	4,826	4,1	70	8	6	4,901032	48,91
UNF 12_28	5,486	4,6	80	10	6	4,901228	50,08
UNF 1/4_28	6,35	5,5	80	10	7	5,501428	50,37
UNF 5/16_24	7,938	6,9	90	13	8	651624	50,97
UNF 3/8_24	9,525	8,5	100	15	10	803824	66,36
UNF 7/16_20	11,112	9,9	100	15	8	6,271620	81,50
UNF 1/2_20	12,7	11,5	100	15	9	701220	115,22
UNF 9/16_20	14,288	12,9	100	15	11	991618	125,34
UNF 5/8_18	15,875	14,5	100	15	12	905818	112,55
UNF 3/4_16	19,05	17,5	110	24	14	1100304	153,55
UNF 1" _12	25,40	23,25	140	27	18	14,500100	309,41

UNF 567

MASCHIATURA RIGIDA
RIGID TAPPING

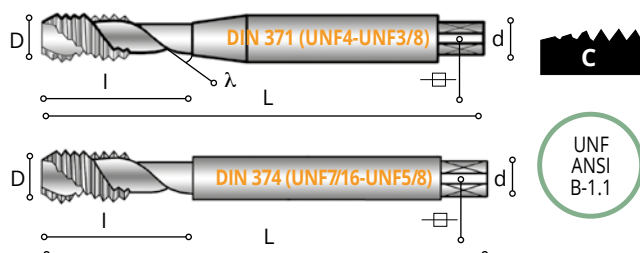

UNF567



D	D (mm)		L	I	d		CODE	RESISTOR 8567..... € OPAL
UNF 4_48	2,844	2,4	56	5	3,5	2,700448	47,80
UNF 5_44	3,175	2,7	56	7	3,5	2,700544	46,60
UNF 6_40	3,505	2,95	56	6	4	300640	47,78
UNF 8_36	4,165	3,5	63	7	4,5	3,400836	44,67
UNF 10_32	4,826	4,1	70	8	6	4,901032	53,00
UNF 12_28	5,486	4,6	80	10	6	4,901228	47,05
UNF 1/4_28	6,35	5,5	80	10	7	5,501428	66,04
UNF 5/16_24	7,938	6,9	90	13	8	651624	62,28
UNF 3/8_24	9,525	8,5	100	15	10	803824	74,55
UNF 7/16_20	11,112	9,9	100	15	8	6,271620	88,48
UNF 1/2_20	12,7	11,5	100	15	9	701220	125,42
UNF 9/16_18	14,288	12,9	100	15	11	991618	135,74
UNF 5/8_18	15,875	14,5	100	15	12	905818	122,22
UNF 3/4_16	19,05	17,5	110	24	14	1100304	165,00
UNF 1" _12	25,40	23,25	140	27	18	14,500100	333,60

M 539 HM
HRC 40-60

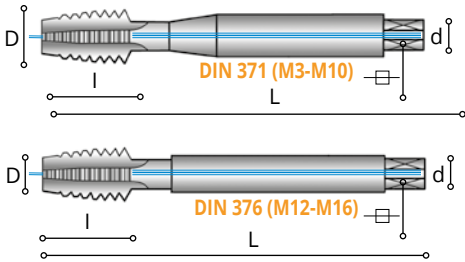

M539



D		L	I	d		CODE	HM 8539..... € OPAL
*M 3 X 0,5	2,5	56	5	3,5	2,700003	205,74
*M 4 X 0,7	3,3	63	7	4,5	3,400004	205,74
*M 5 x 0,8	4,2	70	8	6	4,900005	269,63
M 6 x 1	5	80	10	6	4,900006	269,63
M 8 x 1,25	6,8	90	13	8	6,200008	361,85
M 10 x 1,5	8,5	100	15	10	800010	438,43
M 12 X 1,75	10,2	110	18	9	700012	540,62
M 16 x 2	14	110	20	12	900016	914,71

* Maschi senza foro di lubrificazione / * Taps without internal cooling

CL 28 M HM



M

 λ
15°

60°

2XD

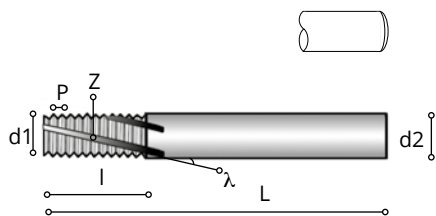

CL28MHM



M	P	d1	L	l	d2	Z	CODE	Micrograin Carbide Co10
								2280..... € SAPPHIRE
M6	1	4,5	57	13	6	300006	189,07
M8	1,25	6	65	17,5	6	300008	227,02
M10	1,5	7,5	72	21	8	400010	251,13
M12	1,75	9,5	80	26,25	10	400012	325,99
M14	2	10	83	30	10	400014	325,99
M16	2	12	92	34	12	400016	443,22

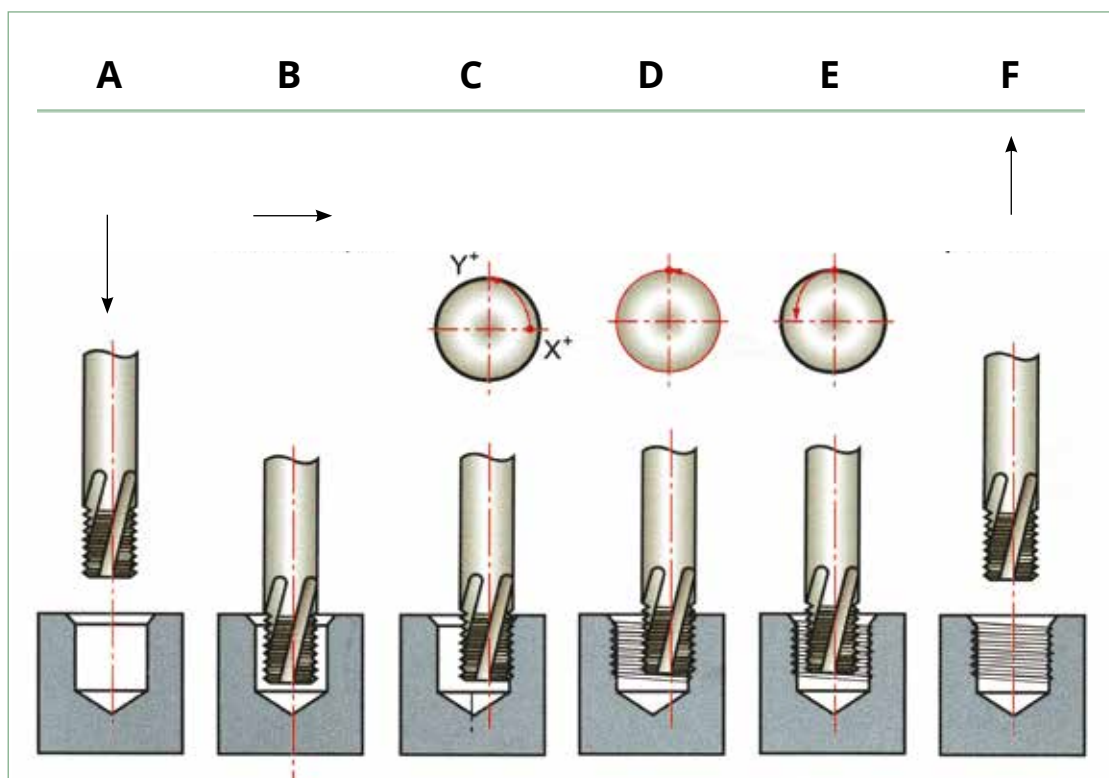

CL 29 MF HM 

MF

λ 15°

60°

2XD

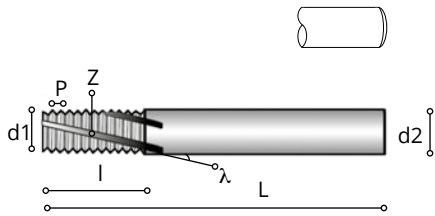

CL29MFHM



MF	P	d1	L	l	d2	Z	CODE	Micrograin Carbide Co10
								2290..... € SAPPHIRE
MF 8	0.75	6	57	12,75	6	307508	189,07
MF 8	1.0	6	57	13	6	310008	189,07
MF 10	1.0	8	63	16	8	410010	251,13
MF 12	1.0	9,5	72	19	10	410012	325,99
MF 12	1.25	9,5	72	18,75	10	412512	325,99
MF 12	1.5	9,5	72	19,5	10	415012	325,99
MF 14	1.0	10	83	22	10	410014	325,99
MF 14	1.5	10	83	22,5	10	415014	325,99
MF 16	1.0	12	83	25	12	410016	402,73
MF 16	1.5	12	83	25,5	12	415016	402,73
MF 18	1.0	14	92	28	14	510018	528,35
MF 18	1.5	14	92	28,5	14	515018	528,35
MF 20	1.0	16	92	31	16	510020	611,46
MF 20	1.5	16	92	31,5	16	515020	611,46

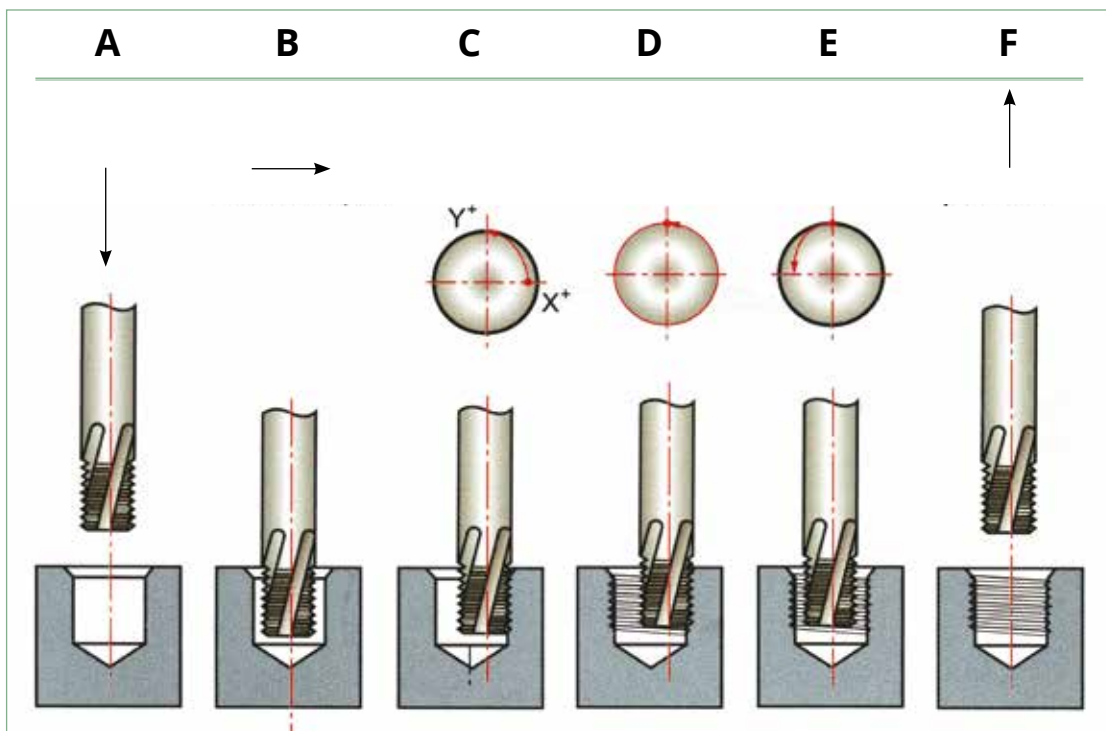

P HM 701

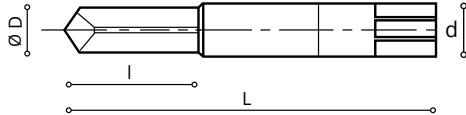

P HM 701



M	Ø D	L	l	d h6	CODE	HM 7701..... € TITANITE
M3	2,5	38	10	300003	68,14
M4	3,3	46	14	400004	96,12
M5	4,2	50	19	500005	108,17
M6	5	50	23	600006	120,16
M8	6,8	60	23	800008	132,22
M10	8,5	80	25	1000010	168,22
M12	10,2	80	35	1200012	244,36

CONSIGLI PER UTILIZZO PUNTA CON LUBRIFICANTE | ADVISE FOR THE CORRECT USE OF THE DRILL WITH LUBRICATION

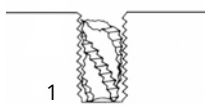

1 - Per un buon centraggio rettificare in piano i maschi spezzati obliquamente
1 - For good centring, obliquely broken off taps have to be ground flat

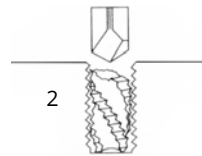

2 - Il centraggio si ottiene dopo essersi avvicinati più volte con l'utensile
2 - Create a centring point by multiple approaches with the drilling out tool

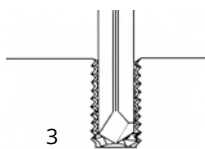

3 - Proseguire con avanzamento costante. Scaricare i trucioli più volte
3 - Drill out with an even feed rate. Evacuate chips frequently

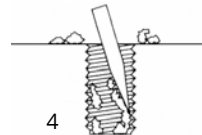

4 - Pulire il foro e rimuovere i residui con un utensile a punta
4 - Clean up the hole and remove debris with a pointed tool

Vc = (m/min) 30 - 60	
	mm/rev
M3	0,06
M4	0,08
M5	0,11
M6	0,11
M8	0,12
M10	0,16
M12	0,20

R 570



R 571



R 572

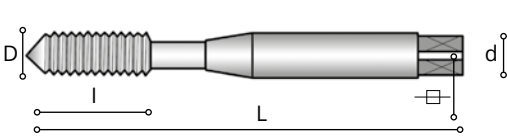

R570



R571



R572



D		L	I	d		CODE	HSS-EX 5570..... €	HSS-EX 5571..... €	HSS-EX 5572..... €
M 2 x 0,4	1,8	45	8	2,8	2,100002			37,71
M 2,3 x 0,4	2,1	45	9	2,8	2,100023			32,10
M 2,6 x 0,45	2,4	50	9	2,8	2,100026			32,10
M 3 x 0,5	2,8	56	11	3,5	2,700003	23,03	23,03	25,67
M 3,5 x 0,6	3,2	56	12	4	300035			28,91
M 4 x 0,7	3,7	63	13	4,5	3,400004	23,03	23,03	25,67
M 5 x 0,8	4,6	70	15	6	4,900005	23,03	23,03	26,48
M 6 x 1	5,5	80	17	6	4,900006	23,03	23,03	26,48
M 8 x 1,25	7,4	90	20	8	6,200008	28,09	28,09	34,51
M 10 x 1,5	9,3	100	22	10	800010	33,70	33,70	40,92

MASCHI A MACCHINA A RULLARE CON CANALINI DI LUBRIFICAZIONE PER FORI PASSANTI E CIECHI
 FLUTELESS TAPS WITH OIL GROOVES FOR THROUGH AND BLIND HOLES

R 573

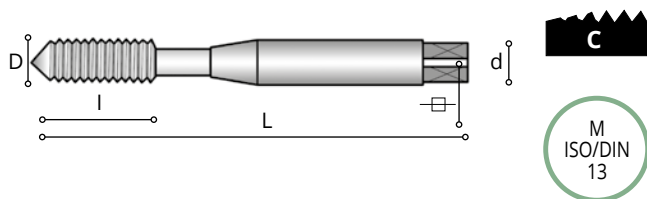

R573



D		L	l	d		CODE	RESISTOR 6573..... € QUARTZ
M 4 x 0,7	3,7	63	7	4,5	3,440030	41,36
M 5 x 0,8	4,65	70	8	6	4,950030	43,44
M 6 x 1	5,55	80	10	6	4,960030	46,33
M 8 x 1,25	7,4	90	13	8	6,280030	55,37
M 10 x 1,5	9,3	100	15	10	810030	67,47

MASCHI A MACCHINA A RULLARE CON CANALINI DI LUBRIFICAZIONE PER FORI PASSANTI E CIECHI
FLUTELESS TAPS WITH OIL GROOVES FOR THROUGH AND BLIND

R 574
HARDOX

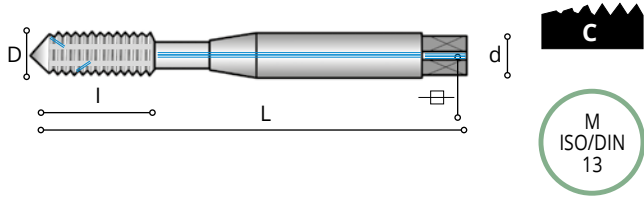

R574



D		L	l	d		CODE	RESISTOR 8574..... € OPAL
M 5 x 0,8	4,65	70	8	6	4,950030	47,08
M 6 x 1	5,55	80	10	6	4,960030	50,19
M 8 x 1,25	7,4	90	13	8	6,280030	59,97
M 10 x 1,5	9,3	100	15	10	810030	73,10



GM 685

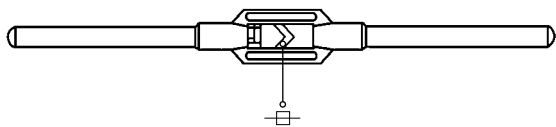

GM685



Il diametro 0 fino ad esaurimento
Diameter 0 until stocks last

Nr.			CODE	HSS 5685..... €
0	2 - 5	M 1 - 800000	19,83
1	2 - 6,3	M 1 - 1000001	21,00
2	3 - 9	M4 - 1200002	31,00
3	4,9 - 12	M 5 - 2000003	44,31
4	5,5 - 16	M 9 - 2700004	62,47
5	7 - 20	M 13 - 3300005	92,83
6	11 - 24	M 19 - 3900006	225,51
7	16 - 39	M 27 - 6400007	225,51

FM 610



FMX 670
INOX



FMS 630

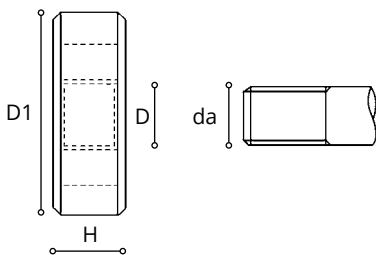

FM610

FMX670

FMS630



D	da	D1	H	CODE	HSS 5610..... €	HSS-E 5670..... €	HSS 5630..... €
M 1,6 x 0,35	1,54	16	5	...00160	28,49		
M 2 x 0,4	1,94	16	5	...00002	28,49		
M 2,5 x 0,45	2,43	16	5	...00025	28,49		
M 3 x 0,5	2,92	20	5	...00003	22,09	29,60	31,54
M 3,5 x 0,6	3,41	20	5	...00035	22,40		31,54
M 4 x 0,7	3,9	20	5	...00004	21,93	29,60	31,54
M 4,5 x 0,75	4,4	20	7	...00045	22,99		33,20
M 5 x 0,8	4,9	20	7	...00005	23,61	31,41	34,58
M 6 x 1	5,88	20	7	...00006	23,61	31,87	34,58
M 7 x 1	6,88	25	9	...00007	26,35		40,37
M 8 x 1,25	7,86	25	9	...00008	25,89	34,94	37,61
M 9 x 1,25	8,86	25	9	...00009	26,35		37,61
M 10 x 1,5	9,85	30	11	...00010	26,81	44,82	39,14
M 11 x 1,5	10,85	30	11	...00011	33,79		52,39
M 12 x 1,75	11,83	38	14	...00012	36,09	60,34	52,39
M 14 x 2	13,82	38	14	...00014	37,77	60,34	55,14
M 16 x 2	15,82	45	18	...00016	50,73	89,80	71,44
M 18 x 2,5	17,79	45	18	...00018	52,39	89,80	72,82
M 20 x 2,5	19,79	45	18	...00020	61,26	96,73	75,45
M 22 x 2,5	21,79	55	22	...00022	70,34	147,57	99,98
M 24 x 3	23,76	55	22	...00024	80,15	147,57	108,40
M 27 x 3	26,76	65	25	...00027	100,80	201,27	193,73
M 30 x 3,5	29,73	65	25	...00030	104,75	201,27	236,23
M 33 x 3,5	32,73	65	25	...00033	108,41		
M 36 x 4	35,7	65	25	...00036	115,62		
M 39 x 4	38,7	75	30	...00039	164,04		
M 42 x 4,5	41,68	75	30	...00042	189,78		
M 45 x 4,5	44,68	90	36	...00450	428,76		
M 48 x 5	47,65	90	36	...00048	428,76		
M 52 x 5	51,65	90	36	...00052	430,43		

FMF 600



FMX 680
INOX



FMFS 640

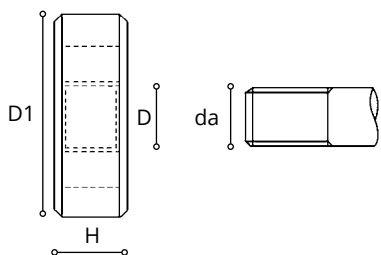

FMF600

FMFX680

FMFS640



D	da	D1	H	CODE	HSS 5600..... €	HSS-E 5680..... €	HSS 5640..... €
MF 2 x 0,25	1,95	16	500002	37,92		
MF 2,5 x 0,35	2,44	16	500025	37,92		
MF 3 x 0,35	2,94	20	500003	27,12		42,34
MF 3,5 x 0,35	3,44	20	500035	27,12		42,34
MF 4 x 0,5	3,93	20	500004	27,12		40,82
MF 4,5x 0,5	4,43	20	500045			40,82
MF 5 x 0,5	4,90	20	500005	27,12		40,82
MF 5,5 x 0,5	5,43	20	500055	27,12		40,82
MF 6 x 0,75	5,90	20	700006	27,12		36,86
MF 7 x 0,75	6,90	25	900007	29,08		44,92
MF 8 x 0,75	7,90	25	907508	29,08		39,75
MF 8 x 1	7,88	25	910008	29,08	37,65	39,75
MF 9 x 0,75	8,90	25	907509	30,82		
MF 9 x 1	8,88	25	910009	30,82		42,59
MF 10 x 0,75	9,90	30	1175010	38,68		
MF 10 x 0,75	9,90	30	1107510			49,20
MF 10 x 1	9,88	30	1110010	37,62	46,76	55,59
MF 10 x 1,25	9,86	30	1112510	37,62		55,59
MF 11 x 0,75	10,90	30	1107511	46,45		
MF 11 x 1	10,88	30	1110011	46,45		68,84
MF 11 x 1,25	10,86	30	1112511			68,84
MF 12 x 1	11,88	38	1010012	46,45		64,74
MF 12 x 1,25	11,86	38	1012512	45,85	61,27	64,74
MF 12 x 1,5	11,85	38	1015012	45,85	61,27	64,74
MF 14 x 1	13,88	38	1010014	46,45		66,13
MF 14 x 1,25	13,86	38	1012514	46,45		66,13
MF 14 x 1,5	13,85	38	1015014	45,85	61,58	66,13
MF 15 x 1	14,88	38	1010015	63,21		71,73
MF 15 x 1,5	14,85	38	1015015	63,21		71,73
MF 16 x 1	15,88	45	1410016	65,95		93,68
MF 16 x 1,25	15,86	45	1412516	64,58		
MF 16 x 1,5	15,85	45	1415016	65,35	91,59	93,68
MF 18 x 1	17,88	45	1410018	65,95		93,68
MF 18 x 1,5	17,85	45	1415018	65,35	91,59	93,68
MF 18 x 2	17,80	45	1420018	65,35		
MF 20 x 1	19,88	45	1410020	68,09		97,88
MF 20 x 1,5	19,85	45	1415020	68,09	103,06	97,88

FMF 600



FMFX 680
INOX



FMFS 640

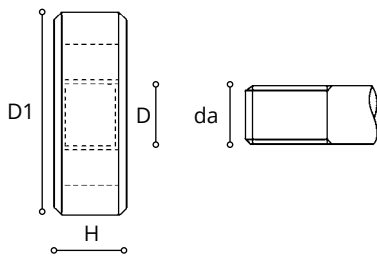

D	da	D1	H	CODE	HSS 5600..... €	HSS-E 5680..... €	HSS 5640..... €
MF 20 x 2	19,80	45	1420020	68,09		
MF 22 x 1	21,88	55	1610022	101,29		141,96
MF 22 x 1,5	21,85	55	1615022	100,38	153,07	141,96
MF 22 x 2	21,80	55	1620022	100,38		
MF 24 x 1	23,88	55	1610024	106,47		151,71
MF 24 x 1,5	23,85	55	1615024	106,47	158,09	151,71
MF 24 x 2	23,80	55	1620024	106,47		
MF 25 x 1,5	24,85	55	1615025	138,91		
MF 25 x 2	24,80	55	1620025	138,91		
MF 26 x 1,5	25,85	55	1615026	138,91		
MF 26 x 2	25,80	55	1620026	138,91		
MF 27 x 1	26,88	65	1810027			210,96
MF 27 x 1,5	26,85	65	1815027	141,80		210,96
MF 27 x 2	26,80	65	1820027	141,80		
MF 28 x 1,5	27,85	65	1815028	141,80		210,96
MF 28 x 2	27,80	65	1820028	141,80		210,96
MF 30 x 1	29,85	65	1810030	144,57		223,12
MF 30 x 1,5	29,85	65	1815030	144,57		223,12
MF 30 x 2	29,80	65	1820030	144,57		
MF 32 x 1,5	31,85	65	1815032	144,88		
MF 32 x 2	31,82	65	1820032	144,88		
MF 33 x 1,5	32,85	65	1815033	149,99		
MF 33 x 2	32,82	65	1820033	149,99		
MF 36 x 1,5	35,85	65	1815036	156,51		
MF 36 x 2	35,82	65	1820036	156,51		
MF 36 x 3	35,76	65	2530036	156,51		
MF 39 x 1,5	38,85	75	2015039	210,89		
MF 39 x 2	38,82	75	2020039	210,89		
MF 39 x 3	38,76	75	3030039	210,89		
MF 40 x 1,5	39,85	75	2015040	210,89		
MF 40 x 2	39,82	75	2020040	210,89		
MF 40 x 3	39,76	75	3030040	210,89		
MF 42 x 1,5	41,85	75	2015042	215,06		
MF 42 x 2	41,82	75	2020042	215,06		
MF 42 x 3	41,76	75	3030042	215,06		
MF 45 x 1,5	44,85	90	2215045	341,66		
MF 45 x 2	44,82	90	2220045	341,66		
MF 45 x 3	44,76	90	3630045	341,66		
MF 48 x 1,5	47,85	90	2215048	341,66		
MF 48 x 2	47,82	90	2220048	341,66		
MF 48 x 3	47,76	90	3630048	341,66		

FMF 600



6g

FMFX 680
INOX



6g

FMFS 640



6g

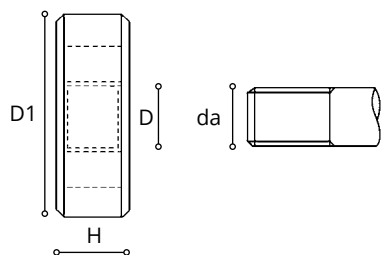

FMF600

FMFX680

FMFS640



D	da	D1	H	CODE	HSS 5600..... €	HSS-E 5680..... €	HSS 5640..... €
MF 50 x 1,5	49,85	90	2215050	354,98		
MF 50 x 2	49,82	90	2220050	354,98		
MF 50 x 3	49,76	90	3630050	354,98		
MF 52 x 1,5	51,85	90	2215052	418,09		
MF 52 x 2	51,82	90	2220052	418,09		
MF 52 x 3	51,76	90	3630052	418,09		

FUNC 645

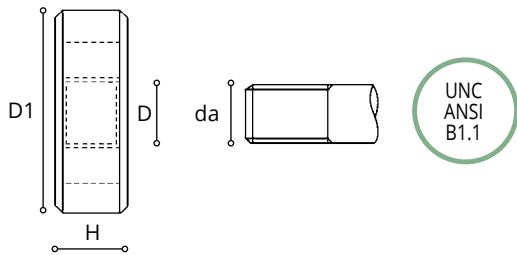

FUNC645



D	da	D1	H	CODE	HSS 5645..... €
UNC 4 - 40	2,76	20	500440	45,30
UNC 5 - 40	3,09	20	500540	45,30
UNC 6 - 32	3,41	20	700632	45,30
UNC 8 - 32	4,07	20	700832	45,30
UNC 10 - 24	4,71	20	701024	45,30
UNC 12 - 24	5,37	20	701224	49,04
UNC 1/4 - 20	6,22	20	701420	44,24
UNC 5/16 - 18	7,80	25	951618	48,75
UNC 3/8 - 16	9,37	30	1103816	54,89
UNC 7/16 - 14	10,95	30	1171614	55,09
UNC 1/2 - 13	12,52	38	1401213	71,46
UNC 9/16 - 12	14,10	38	1491612	71,72
UNC 5/8 - 11	15,68	45	1805811	98,77
UNC 3/4 - 10	18,84	45	1803410	99,08
UNC 7/8 - 9	22,00	55	2207809	136,26
UNC 1" - 8	25,16	55	2201008	143,64

FUNF 650

DIN EN
22568

2A

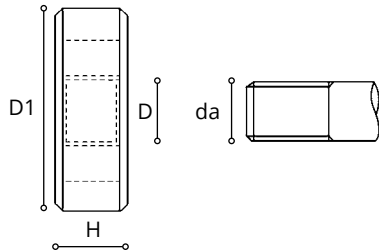
UNF
ANSI
B1.1

FUNF650



D	da	D1	H	CODE	HSS 5650..... €
UNF 4 - 48	2,77	20	500448	41,83
UNF 5 - 44	3,10	20	500544	39,25
UNF 6 - 40	3,42	20	500640	39,25
UNF 8 - 36	4,08	20	700836	39,25
UNF 10 - 32	4,73	20	701032	39,26
UNF 12 - 28	5,38	20	701228	42,50
UNF 1/4 - 28	6,24	20	701428	44,24
UNF 5/16 - 24	7,82	25	951624	47,72
UNF 3/8 - 24	9,41	30	1103824	54,89
UNF 7/16 - 20	10,98	30	1171620	48,60
UNF 1/2 - 20	12,56	38	1001220	71,72
UNF 9/16 - 18	14,14	38	1091618	72,03
UNF 5/8 - 18	15,73	45	1405818	98,77
UNF 3/4 - 16	18,89	45	1403416	99,08
UNF 7/8 - 14	22,05	55	1607814	136,26
UNF 1" - 12	25,21	55	1601012	143,64

FG 620



FGX 622
INOX



FG620

FGX622

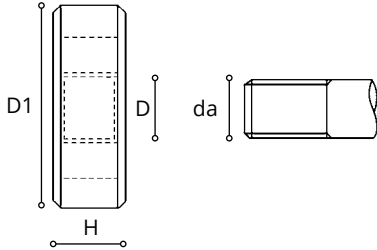

D	da	D1	H	CODE	HSS 5620..... €	HSS-E 5622..... €
G 1/8 - 28	9,58	30	1100108	37,48	45,14
G 1/4 - 19	13,01	38	1000104	37,48	56,24
G 3/8 - 19	16,51	45	1400308	62,15	89,63
G 1/2 - 14	20,80	45	1400102	61,53	89,63
G 5/8 - 14	22,77	55	1600508	75,70	
G 3/4 - 14	26,26	55	1600304	110,12	141,85
G 7/8 - 14	30,02	65	1800708	111,18	
G 1" - 11	33,07	65	1800100	115,15	207,57
G 1" 1/8 - 11	37,72	75	2001108	163,43	
G 1" 1/4 - 11	41,73	75	2010104	163,43	
G 1" 3/8 - 11	44,14	90	2201308	203,34	
G 1" 1/2 - 11	47,62	90	2201102	208,51	
G 1" 3/4 - 11	53,57	105	2201304	235,31	
G 2" - 11	59,43	105	2200200	320,45	

FW 660

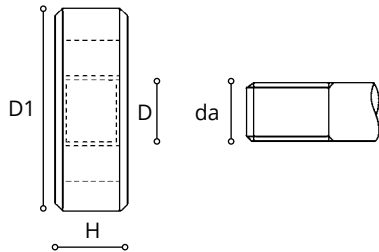

FW660



D	da	D1	H	CODE	HSS 5660..... €
W 1/16-60	1,51	16	500116	50,64
W 3/32-48	2,3	16	500332	36,04
W 1/8-40	3,09	20	500108	32,04
W 5/32-32	3,88	20	500532	36,04
W 3/16-24	4,66	20	700316	32,04
W 7/32-24	5,46	20	700732	37,96
W 1/4-20	6,24	20	700104	34,06
W 5/16-18	7,82	25	900516	35,24
W 3/8-16	9,4	30	1100308	42,04
W 7/16-14	10,98	30	1100716	43,04
W 1/2-12	12,56	38	1400102	57,07
W 9/16-12	14,14	38	1400916	60,96
W 5/8-11	15,72	45	1800508	80,09
W 3/4-10	18,89	45	1800304	85,09
W 7/8-9	22,1	55	2200708	120,13
W 1"-8	25,27	55	2200100	132,14
W 1" 1/8-7	28,44	65	2501108	164,98
W 1" 1/4-7	31,61	65	2501104	179,81
W 1" 3/8-6	34,77	65	2501308	179,81
W 1" 1/2-6	37,95	75	3001102	251,08

FNPT 690

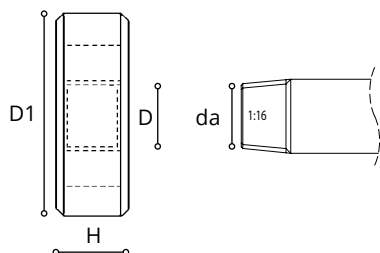

FNPT690



D	da	D1	H	CODE	HSS 5690..... €
NPT 1/8 - 27	9,99	30	1100108	55,13
NPT 1/4 - 18	13,26	38	1400104	66,41
NPT 3/8 - 18	16,67	45	1800308	93,60
NPT 1/2 - 14	20,71	45	1800102	96,60
NPT 3/4 - 14	26,03	55	2200304	182,04
NPT 1" - 11.1/2	32,59	65	2500100	210,65

FPG 691



FPG691

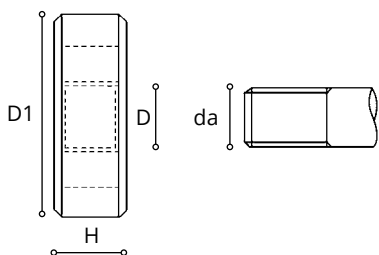

D	da	D1	H	CODE	HSS 5691..... €
PG 7 - 20	12,4	38	1000007	37,69
PG 9 - 18	15,1	45	1400009	54,71
PG 11 - 18	18,5	45	1400011	54,71
PG 13,5 - 18	20,3	45	1400135	54,71
PG 16 - 18	22,4	55	1600016	114,77
PG 21 - 16	28,15	65	1800021	141,93
PG 29 - 16	36,85	65	1800029	141,93













PF 856



PF856



Nr.	D x H		CODE	HSS 5856..... €
0	16 x 5	M 1 - 2,600000	14,61
1	20 x 5	MF 3 - 400001	17,37
2	20 x 7	M 4,5 - 600002	17,37
3	25 x 9	M 7 - 900003	20,70
4	30 x 11	M 10 - 1100004	22,99
5	38 x 14	M 12 - 1400005	26,03
6	38 x 10	MF 12 - 1400006	26,03
7	45 x 18	M 16 - 2000007	36,37
8	45 x 14	MF 16 - 2000008	36,37
9	55 x 22	M 22 - 2400009	46,50
10	55 x 16	MF 22 - 2400010	46,50
11	65 x 25	M 27 - 3600011	76,48
12	65 x 18	MF 26 - 3500012	76,48
13	75 x 30	M 39 - 4200013	127,54
14	75 x 20	MF 38 - 4200014	127,54

Articolo Article	Tipo Type	Angolo vertice Point angle	Materiale tipo Tool material	Superficie Surface	Standard	gamma dal (mm) diameter range (mm)	pag page
CALIBRI A TAMPONE PASSA / NON PASSA SMOOTH PLUG GAUGES GO / NO-GO							
 TL 800	P - NP GO - NO/GO					2,00 - 30,00	204
 TF M810	P - NP GO - NO/GO					M2 - M52	205
 AF M820	P GO					M2 - M52	205
 AF M821	NP NO/GO					M2 - M52	205
 TF MF 811	P - NP GO - NO/GO					MF4 - MF52	206
 AF MF822	P GO					MF4 - MF52	206
 AF MF823	NP NO/GO					MF4 - MF52	206
 TF G812	P - NP GO - NO/GO					G1/8 - 28 G1" - 1/2	208
 AF G824	P GO					G1/8 - 28 G1" - 1/2	208
 AF G825	NP NO/GO					G1/8 - 28 G1" - 1/2	208
 TF UNC813	P - NP GO - NO/GO					UNC5 - 40 UNC2"	209
 TF UNF814	P - NP GO - NO/GO					UNF5 - 44 UNF1" - 1/2	210
 TF NPT815						NPT1/16 NPT2"	211

Calibration Certificate

inspection certificate meets the requirements of the ISO 9001:2008

carmon
 Utensileria Carmon Srl
 Via Matteotti, 142
 25014 Castenedolo (BS) • Italia
 P.Iva / C.F. 00361110174
 www.carmon.it

Customer: Utensileria Carmon Srl
 Type of gauge: Internal screw gauge
 Thread designation: M32x1.5 - 7H
 Standard: ISO 1502
 1. Flank angle: 30°±12'
 2. Flank angle: 30°±12'
 Pitch: 1.5±0.005mm
 Method of measurement: Three-wire-method
 Used wire diameter: Ø0.895
 Measuring force: 2.5 N

Part number: 13290137/1329138

Gauge nominal values

	GO side	NO GO side
Major diameter (max):	φ32.03mm	φ31.597mm
Major diameter (min):	φ32.002mm	φ31.569mm
Effective diameter (max):	φ31.049mm	φ31.29mm
Effective diameter (min):	φ31.035mm	φ31.276mm
Minor diameter - maximum value:	φ30.1595mm	φ30.1595mm
Effective diameter - Wear limit:	φ31.021mm	φ31.268mm

Measuring values of Effective diameter GO side

Meas. Plane No.	Meas. Value No.	Measure [mm]	Effective φ [mm]
1	1	32.425	31.039
2	1	32.425	31.039

Measuring values of Effective diameter NO GO side

Meas. Plane No.	Meas. Value No.	Measure [mm]	Effective φ [mm]
1	1	32.6715	31.2855
2	1	32.672	31.286

Valuation: Gauge in tolerance
 Uncertainty of measurement: ±0.0018 mm
 Measurement equipment: Abbe - measuring machine; Nr 4034; Date of Calibration 2011-12.
 Traceability: Gauge blocks sets made of steel MLAr-112; Nr 970186; Date of calibration 2011-12.
 Reference temperature: VDI/VDE/DGQ/2618
 Date: 20.6°C
 Operator: 2013-09-09
 xxxxxxxxxxxx

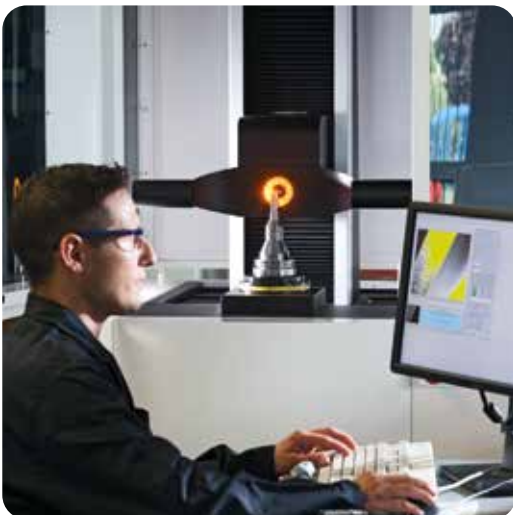

Tutti i calibri tamponi lisci, filettati e anelli passa/non passa sono accompagnati da un certificato di controllo dimensionale ISO9001. A richiesta è possibile avere il certificato di taratura LAT.

All internal flat and threaded screw gauges and the rings go/no go are accompanied by an ISO9001 certificate of dimensional control. Upon request it's possible to have the certificate of calibration LAT.

Alle Kaliber, Lehdornen, Gut- und Ausschlusslehren und Lehrringe werden mit einem Mess-Pruefzeugnis geliefert ISO9001. Auf Anfrage kann man auch eine LAT Bescheinigung liefern.

Toutes les calibres / tampons filetés et lisses et toutes les bagues entre/n'entre pas sont accompagnés d'un certificat de contrôle dimensionnel ISO9001. Sur commande vous pouvez demander le certificat d'étalonnage LAT.

Todos los calibres machos de roscas y lisos y los anelos pasa/no pasa se entregan con un certificado de control dimensional ISO9001. Es también posible tener el certificado de calibración LAT previa petición.

TL 800

P - NP GO - NO/GO

H7

TL 800



D	CODE	5800..... €
200002	84,87
300003	77,67
400004	77,67
500005	77,67
600006	77,67
700007	77,67
800008	77,67
900009	87,33
1000010	89,52
1100011	113,38
1200012	94,56
1300013	113,38
1400014	94,56
1500015	127,68
1600016	106,42
1700017	127,68
1800018	106,42
1900019	143,41
2000020	119,49
2100021	143,41
2200022	119,49
2300023	143,41
2400024	119,49
2500025	133,88
2600026	133,88
2700027	133,88
2800028	133,88
2900029	160,67
3000030	133,88

TF M810 P - NP GO - NO/GO

AF M820 P - GO

AF M821 NP - NO/GO



6H



6g



6g

TF M810



AF M820



AF M821



M	P	CODE	5810..... €	5820..... €	5821..... €
M 2	0,4000002	206,92	199,73	199,73
M 2,5	0,4500025	192,06	199,73	199,73
M 3	0,5000003	167,74	159,77	159,77
M 3,5	0,6000035	185,47	159,77	159,77
M 4	0,7000004	137,61	159,77	159,77
M 4,5	0,7500450	197,49	159,77	159,77
M 5	0,8000005	132,25	159,77	159,77
M 6	1,0000006	133,42	159,77	159,77
M 7	1,0000007	161,46	159,77	159,77
M 8	1,2500008	148,15	159,77	159,77
M 9	1,2500009	183,68	175,71	175,71
M 10	1,5000010	151,36	175,71	175,71
M 12	1,7500012	167,12	175,71	175,71
M 14	2,0000014	161,04	191,72	191,72
M 16	2,0000016	182,91	191,72	191,72
M 18	2,5000018	209,01	275,60	275,60
M 20	2,5000020	238,27	275,60	275,60
M 22	2,5000022	235,86	275,60	275,60
M 24	3,0000024	243,03	275,60	275,60
M 27	3,0000027	269,84	335,48	335,48
M 30	3,5000030	281,69	499,22	499,22
M 33	3,5000033	319,52	499,22	499,22
M 36	4,0000036	320,12	499,22	499,22
M 39	4,0000039	331,84	499,22	499,22
M 42	4,5000042	351,35	567,16	567,16
M 45	4,5000045	350,03	567,16	567,16
M 48	5,0000048	379,82	658,99	658,99
M 52	5,0000052	452,24	678,41	678,41

TF MF811 P - NP GO - NO/GO



6H

AF MF822 P - GO



6g

AF MF823 NP - NO/GO



6g

TF MF811



AF MF822



AF MF823



MF	P	CODE	5811..... €	5822..... €	5823..... €
MF 4	0,5000004	155,46	299,88	299,88
MF 4,5	0,5000045	155,46	314,78	314,78
MF 5	0,5000005	155,46	299,88	299,88
MF 6	0,5005006	156,83	378,48	378,48
MF 6	0,7507506	156,83	299,88	299,88
MF 8	0,5005008	204,59	378,48	378,48
MF 8	0,7507508	204,59	299,88	299,88
MF 8	1,0010008	184,12	191,99	191,99
MF 10	0,7507510	215,48	299,88	299,88
MF 10	1,0010010	196,36	216,27	216,27
MF 10	1,2512510	196,36	216,27	216,27
MF 12	1,0010012	231,85	216,27	216,27
MF 12	1,2512512	231,85	216,27	216,27
MF 12	1,5015012	205,64	216,27	216,27
MF 14	1,0010014	238,67	226,12	226,12
MF 14	1,2512514	238,67	226,12	226,12
MF 14	1,5015014	198,12	226,12	226,12
MF 16	1,0010016	265,96	226,12	226,12
MF 16	1,5015016	235,93	226,12	226,12
MF 18	1,0010018	247,79	290,03	290,03
MF 18	1,5015018	207,29	290,03	290,03
MF 18	2,0020018	214,43	290,03	290,03
MF 20	1,0010020	274,63	290,03	290,03
MF 20	1,5015020	263,34	290,03	290,03
MF 20	2,0020020	249,57	290,03	290,03
MF 22	1,0010022	268,36	290,03	290,03
MF 22	1,5015022	242,65	290,03	290,03
MF 22	2,0020022	242,65	290,03	290,03
MF 24	1,0010024	304,10	290,03	290,03
MF 24	1,5015024	250,80	290,03	290,03
MF 24	2,0020024	250,80	290,03	290,03
MF 25	1,5015025	272,75	339,19	339,19
MF 26	1,5015026	261,84	339,19	339,19
MF 27	1,5015027	267,30	339,19	339,19
MF 27	2,0020027	267,30	339,19	339,19
MF 28	1,5015028	272,75	339,19	339,19
MF 28	2,0020028	283,65	339,19	339,19
MF 30	1,0010030	287,79	521,05	521,05
MF 30	1,5015030	272,75	412,95	412,95
MF 30	2,0020030	287,79	412,95	412,95

MF	P	CODE	5811..... €	5822..... €	5823..... €
MF 32	1,5015032	293,44	412,95	412,95
MF 33	1,5015033	316,38	412,95	412,95
MF 33	2,0020033	316,38	412,95	412,95
MF 33	3,0030033	339,53	521,05	521,05
MF 35	1,5015035	314,65	412,95	412,95
MF 36	1,5015036	316,01	412,95	412,95
MF 36	2,0020036	321,02	412,95	412,95
MF 36	3,0030036	319,77	521,05	521,05
MF 38	1,5015038	310,37	412,95	412,95
MF 39	2,0020039	319,77	412,95	412,95
MF 39	3,0030039	319,77	521,05	521,05
MF 40	1,5015040	322,78	412,95	412,95
MF 40	2,0020040	319,77	412,95	412,95
MF 40	3,0030040	329,55	521,05	521,05
MF 42	1,5015042	319,77	481,75	481,75
MF 42	2,0020042	329,18	481,75	481,75
MF 42	3,0030042	333,56	570,20	570,20
MF 45	1,5015045	325,04	481,75	481,75
MF 45	2,0020045	334,07	481,75	481,75
MF 45	3,0030045	334,19	575,15	575,15
MF 48	1,5015048	333,56	481,75	481,75
MF 48	2,0020048	326,04	481,75	481,75
MF 48	3,0030048	331,06	575,15	575,15
MF 50	1,5015050	326,04	481,75	481,75
MF 50	2,0020050	334,19	481,75	481,75
MF 50	3,0030050	357,64	575,15	575,15
MF 52	1,5015052	357,64	629,22	629,22
MF 52	2,0020052	373,19	658,72	658,72
MF 52	3,0030052	373,19	737,37	737,37

TF G812 P - NP GO - NO/GO

AF G824 P - GO

AF G825 NP - NO/GO



TF G812

AF G824

AF G825



GAS	D	CODE	5812..... €	5824..... €	5825..... €
G 1/8 - 28	9,7300108	220,98	283,55	283,55
G 1/4 - 19	13,1600104	220,95	283,55	283,55
G 3/8 - 19	16,6600308	233,23	283,55	283,55
G 1/2 - 14	20,9600102	276,23	283,55	283,55
G 5/8 - 14	22,9100508	293,65	335,48	335,48
G 3/4 - 14	26,4400304	331,48	335,48	335,48
G 7/8 - 14	30,200708	368,31	335,48	335,48
G 1" - 11	33,2500100	405,14	475,27	475,27
G 1" 1/8 - 11	37,901108	419,87	475,27	475,27
G 1" 1/4 - 11	41,9101104	446,53	475,27	475,27
G 1" 1/2 - 11	47,801102	475,15	475,27	475,27

TF UNC813 P - NP GO - NO/GO



TF UNC813



UNC	D	CODE	5813..... €
UNC 5 - 40	3,1800540	164,96
UNC 6 - 32	3,5100632	164,96
UNC 8 - 32	4,1700832	164,96
UNC 10 - 24	4,8301024	164,96
UNC 12 - 24	5,4901224	164,96
UNC 1/4 - 20	6,3501420	217,02
UNC 5/16 - 18	7,9451618	217,02
UNC 3/8 - 16	9,5303816	227,16
UNC 7/16 - 14	11,1171614	227,16
UNC 1/2 - 13	12,701213	234,41
UNC 9/16 - 12	14,2991612	234,41
UNC 5/8 - 11	15,8805811	310,62
UNC 3/4 - 10	19,0503410	310,75
UNC 7/8 - 9	22,2307809	310,62
UNC 1" - 8	25,401008	348,27
UNC 1" 1/8 - 7	28,5811807	348,10
UNC 1" 1/4 - 7	31,7511407	390,49
UNC 1" 3/8 - 6	34,9313806	390,49
UNC 1" 1/2 - 6	38,111206	390,49
UNC 1" 3/4 - 5	44,4513405	417,74
UNC 2" - 4,5	50,800200	498,26

TF UNF814 P - NP GO - NO/GO



2B

TF UNF814

UNF
ANSI
B1.1

UNF	D	CODE	5814..... €
UNF 5 - 44	3,1800544	164,95
UNF 6 - 40	3,5100640	164,95
UNF 8 - 36	4,1700836	158,07
UNF 10 - 32	4,8301032	158,09
UNF 12 - 28	5,4901228	164,96
UNF 1/4 - 28	6,3501428	164,96
UNF 5/16 - 24	7,9451624	164,96
UNF 3/8 - 24	9,5303824	217,70
UNF 7/16 - 20	11,1171620	217,70
UNF 1/2 - 20	12,7001220	234,41
UNF 9/16 - 18	14,2991618	210,94
UNF 5/8 - 18	15,8805818	297,80
UNF 3/4 - 16	19,0503416	297,80
UNF 7/8 - 14	22,2307814	310,75
UNF 1" - 12	25,4001012	348,27
UNF 1" 1/8 - 12	28,5811812	348,27
UNF 1" 1/4 - 12	31,7511412	390,49
UNF 1" 3/8 - 12	34,9313812	390,49
UNF 1" 1/2 - 12	38,1011212	390,49

















TF NPT815































TF NPT815













NPT	P	CODE	5815..... €
NPT 1/16	2700116	251,05
NPT 1/8	2700108	236,63
NPT 1/4	1800104	256,17
NPT 3/8	1800308	276,69
NPT 1/2	1400102	297,78
NPT 3/4	1400304	326,48
NPT 1"	11,500100	366,07
NPT 1" 1/4	11,501104	400,36
NPT 1" 1/2	11,501102	417,76
NPT 2"	11,500200	478,51















Articolo Article	Tipo Type	Campo d'applicazione Application field	Angolo elica Point Helix	Materiale tipo Tool material	Superficie Surface	Standard	Gamma dal diameter range	pag page
FRESE A CODOLO CILINDRICO STRAIGHT SHANK AND MILLS								
FRESE A DUE TAGLIENTI TWO FLUTE SLOT DRILLS								
 CL 11	N	Acciai comuni Standard steel Acciai tenaci hardened steel	30	HSS+8%CO	White	DIN 327 D	1 - 40	232
 CL 11	N	Acciai comuni Standard steel Acciai tenaci hardened steel	30	HSS+8%CO	Sapphire MULTI	DIN 327 D	1 - 25	232
 CL 11 resistor	N	Acciai comuni Standard steel Acciai tenaci hardened steel	30	RESISTOR	White	DIN 327 D	2 - 25	232
 CL 11 resistor	N	Acciai comuni Standard steel Acciai tenaci hardened steel	30	RESISTOR	Sapphire MULTI	DIN 327 D	2 - 25	232
 CL 12	N	Acciai comuni Standard steel Acciai tenaci hardened steel	30	HSS+8%CO	White	CARMON NORM	3 - 25	234
 CL 12	N	Acciai comuni Standard steel Acciai tenaci hardened steel	30	HSS+8%CO	Sapphire MULTI	CARMON NORM	3 - 25	234
 CL 12 resistor	N	Acciai comuni Standard steel Acciai tenaci hardened steel	30	RESISTOR	White	CARMON NORM	3 - 25	234
 CL 12 resistor	N	Acciai comuni Standard steel Acciai tenaci hardened steel	30	RESISTOR	Sapphire MULTI	CARMON NORM	3 - 25	234
 CL 13F	N	Acciai comuni Standard steel Acciai tenaci hardened steel	30	HSS+8%CO	White	DIN 327 H	4 - 40	235
 CL 18	N	Acciai comuni Standard steel Acciai tenaci hardened steel	30	HSS+8%CO	White	DIN 327 D	2 - 20	236
 CL 19	N	Acciai comuni Standard steel Acciai tenaci hardened steel	30	HSS+8%CO	White	CARMON NORM	3 - 20	237
FRESE A TRE TAGLIENTI THREE FLUTE END MILLS								
 CL 16	N	Acciai comuni Standard steel Acciai tenaci hardened steel	30	HSS+8%CO	White	DIN 844 B	2 - 25	238
 CL 16	N	Acciai comuni Standard steel Acciai tenaci hardened steel	30	HSS+8%CO	Sapphire MULTI	DIN 844 B	2 - 25	238
 CL 16 resistor	N	Acciai comuni Standard steel Acciai tenaci hardened steel	30	RESISTOR	White	DIN 844 B	3 - 25	238
 CL 16 resistor	N	Acciai comuni Standard steel Acciai tenaci hardened steel	30	RESISTOR	Sapphire MULTI	DIN 844 B	3 - 25	238
 CL 30 FE	N	Acciai comuni Standard steel Acciai tenaci hardened steel	45	HSS+8%CO	White	DIN 844 B	6 - 20	239
 CL 17	N	Acciai comuni Standard steel Acciai tenaci hardened steel	30	HSS+8%CO	White	DIN 844 B	3 - 25	240









Articolo Article	Tipo Type	Campo d'applicazione Application field	Angolo elica Point Helix	Materiale tipo Tool material	Superficie Surface	Standard	Gamma dal diameter range	pag page
FRESE CILINDRICHE FRONTALI MULTIFLUTE FINISHING CUTTERS								
 CL 21 TF	N	Acciai comuni Standard steel Acciai tenaci hardened steel	30	HSS+8%CO	White	DIN 844 B	3 - 40	241
 CL 21 TF	N	Acciai comuni Standard steel Acciai tenaci hardened steel	30	HSS+8%CO	Sapphire MULTI	DIN 844 B	3 - 32	241
 CL 21 TF resistor	N	Acciai comuni Standard steel Acciai tenaci hardened steel	30	RESISTOR	White	DIN 844 B	3 - 32	241
 CL 21 TF resistor	N	Acciai comuni Standard steel Acciai tenaci hardened steel	30	RESISTOR	Sapphire MULTI	DIN 844 B	3 - 32	241
 CL 21 TF resistor	N	Acciai inox Stainless steel	30	RESISTOR	Pearl	DIN 844 B	3 - 32	241
 CL 22 TF	N	Acciai comuni Standard steel Acciai tenaci hardened steel	30	HSS+8%CO	White	DIN 844 B	3 - 25	242
 CL 22 TF	N	Acciai comuni Standard steel Acciai tenaci hardened steel	30	HSS+8%CO	Sapphire MULTI	DIN 844 B	3 - 25	242
 CL 22 TF resistor	N	Acciai comuni Standard steel Acciai tenaci hardened steel	30	RESISTOR	White	DIN 844 B	3 - 25	242
 CL 22 TF resistor	N	Acciai comuni Standard steel Acciai tenaci hardened steel	30	RESISTOR	Sapphire MULTI	DIN 844 B	3 - 25	242
FRESE CILINDRICHE FRONTALI A SGROSSARE ROUGHING END MILLS								
 CL 24 TF	NR	Acciai comuni Standard steel acciai tenaci hardened steel	30	HSS+8%CO	White	DIN 844 B	6 - 40	243
 CL 24 TF	NR	Acciai comuni Standard steel acciai tenaci hardened steel	30	HSS+8%CO	Sapphire MULTI	DIN 844 B	6 - 32	243
 CL 24 TF resistor	NR	Acciai comuni Standard steel acciai tenaci hardened steel	30	RESISTOR	White	DIN 844 B	6 - 32	243
 CL 24 TF resistor	NR	Acciai comuni Standard steel acciai tenaci hardened steel	30	RESISTOR	Sapphire MULTI	DIN 844 B	6 - 32	243
 CL 24 TF resistor	NR	Acciai inox Stainless steel	30	RESISTOR	Pearl	DIN 844 B	6 - 32	243
 CL 24 TF PF	HR	Acciai comuni Standard steel acciai tenaci hardened steel	30	HSS+8%CO	White	DIN 844 B	6 - 40	244
 CL 24 TF PF	HR	Acciai comuni Standard steel acciai tenaci hardened steel	30	HSS+8%CO	Sapphire MULTI	DIN 844 B	6 - 32	244
 CL 24 TF PF resistor	HR	Acciai comuni Standard steel acciai tenaci hardened steel	30	RESISTOR	White	DIN 844 B	6 - 32	244
 CL 24 TF PF resistor	HR	Acciai comuni Standard steel acciai tenaci hardened steel	30	RESISTOR	Sapphire MULTI	DIN 844 B	6 - 32	244

Articolo Article	Tipo Type	Campo d'applicazione Application field	Angolo elica Point Helix	Materiale tipo Tool material	Superficie Surface	Standard	Gamma dal diameter range	pag page
 CL 24 TF PF resistor	HR	Acciai inox Stainless steel	30	RESISTOR	Pearl	DIN 844 B	6 - 32	244
 CL 24 SL - TF	NR	Acciai comuni Standard steel Acciai tenaci hardened steel	30	HSS+8%CO	White	DIN 844 B	6- 25	245
 CL 24 SL - TF	NR	Acciai comuni Standard steel Acciai tenaci hardened steel	30	HSS+8%CO	Sapphire MULTI	DIN 844 B	6- 25	245
 CL 24 SL - TFPF	HR	Acciai comuni Standard steel Acciai tenaci hardened steel	30	HSS+8%CO	White	DIN 844 B	6- 25	246
 CL 24 SL - TFPF	HR	Acciai comuni Standard steel Acciai tenaci hardened steel	30	HSS+8%CO	Sapphire MULTI	DIN 844 B	6- 25	246
 CL 25 TF	NF	Acciai comuni Standard steel Acciai tenaci hardened steel	30	HSS+8%CO	White	DIN 844 B	6 - 25	247
 CL 25 TF	NF	Acciai comuni Standard steel Acciai tenaci hardened steel	30	HSS+8%CO	Sapphire MULTI	DIN 844 B	6 - 25	247
FRESE A CODOLO CONICO MORSE TAPER SHANK END MILLS								
FRESE CILINDRICHE A DUE TAGLIANTI TWO FLUTE SLOT MILLS								
 CM 31	N	Acciai comuni Standard steel Acciai tenaci hardened steel	30	HSS+8%CO	White	DIN 326 D	14 - 40	248
FRESE CILINDRICHE A TRE TAGLIANTI THREE FLUTE SLOT MILLS								
 CM 36	N	Acciai comuni Standard steel Acciai tenaci hardened steel	30	HSS+8%CO	White	DIN 845 B	14 - 40	249
 CM 37 FE	N	Acciai comuni Standard steel Acciai tenaci hardened steel	45	HSS+8%CO	White	DIN 845 B	16 - 40	249
 CM 38	N	Acciai comuni Standard steel Acciai tenaci hardened steel	30	HSS+8%CO	White	DIN 845 B	16 - 40	250
FRESE CILINDRICHE FRONTALI MULTIFLUTE FINISHING CUTTERS								
 CM 41 TF	N	Acciai comuni Standard steel Acciai tenaci hardened steel	30	HSS+8%CO	White	DIN 845 B	14 - 50	251
 CM 41 TF	N	Acciai comuni Standard steel Acciai tenaci hardened steel	30	HSS+8%CO	Sapphire MULTI	DIN 845 B	14 - 40	251
 CM 41 TF resistor	N	Acciai comuni Standard steel Acciai tenaci hardened steel	30	RESISTOR	White	DIN 845 B	16 - 50	251
 CM 41 TF resistor	N	Acciai comuni Standard steel Acciai tenaci hardened steel	30	RESISTOR	Sapphire MULTI	DIN 845 B	16 - 40	251
 CM 41 R	N	Acciai comuni Standard steel Acciai tenaci hardened steel	30	HSS+8%CO	White	DIN 1899 2D	16 - 40	252
 CM 44 R	NR	Acciai comuni Standard steel Acciai tenaci hardened steel	30	HSS+8%CO	White	DIN 1899 2D	16 - 40	252

Articolo Article	Tipo Type	Campo d'applicazione Application field	Angolo elica Point Helix	Materiale tipo Tool material	Superficie Surface	Standard	Gamma dal diameter range	pag page
 CM 42	N	Acciai comuni Standard steel Acciai tenaci hardened steel	30	HSS+8%CO	White	DIN 845 B	16 - 50	252
 CM 42	N	Acciai comuni Standard steel Acciai tenaci hardened steel	30	HSS+8%CO	Sapphire MULTI	DIN 845 B	16 - 40	252
 CM 42 resistor	N	Acciai comuni Standard steel Acciai tenaci hardened steel	30	RESISTOR	White	DIN 845 B	16 - 50	252
 CM 42 resistor	N	Acciai comuni Standard steel Acciai tenaci hardened steel	30	RESISTOR	Sapphire MULTI	DIN 845 B	16 - 40	252
 CM 42 R	N	Acciai comuni Standard steel Acciai tenaci hardened steel	30	HSS+8%CO	White	DIN 1899 2D	16 - 40	253
 CM 48 R	NR	Acciai comuni Standard steel Acciai tenaci hardened steel	30	HSS+8%CO	White	DIN 1899 2D	16 - 40	253
 CM 43	N	Acciai comuni Standard steel Acciai tenaci hardened steel	20	HSS+8%CO	White	CARMON NORM	16 - 40	253
 CM 44 TF	NR	Acciai comuni Standard steel Acciai tenaci hardened steel	30	HSS+8%CO	White	DIN 845 B	16 - 50	254
 CM 44 TF	NR	Acciai comuni Standard steel Acciai tenaci hardened steel	30	HSS+8%CO	Sapphire MULTI	DIN 845 B	16 - 40	254
 CM 44 TF resistor	NR	Acciai comuni Standard steel Acciai tenaci hardened steel	30	RESISTOR	White	DIN 845 B	16 - 40	254
 CM 44 TF resistor	NR	Acciai comuni Standard steel Acciai tenaci hardened steel	30	RESISTOR	Sapphire MULTI	DIN 845 B	16 - 40	254
 CM 48	NR	Acciai comuni Standard steel Acciai tenaci hardened steel	30	HSS+8%CO	White	DIN 845 B	16 - 50	255
 CM 48	NR	Acciai comuni Standard steel Acciai tenaci hardened steel	30	HSS+8%CO	Sapphire MULTI	DIN 845 B	16 - 40	255
 CM 48 resistor	NR	Acciai comuni Standard steel Acciai tenaci hardened steel	30	RESISTOR	White	DIN 845 B	16 - 50	255
 CM 48 resistor	NR	Acciai comuni Standard steel Acciai tenaci hardened steel	30	RESISTOR	Sapphire MULTI	DIN 845 B	16 - 40	255
 CM 45 TF	NF	Acciai comuni Standard steel Acciai tenaci hardened steel	30	HSS+8%CO	White	DIN 845 B	16 - 50	256
FRESE CONICHE PER STAMPI DIESINKING MILLING CUTTERS								
 CS 47	N	Acciai comuni Standard steel Acciai tenaci hardened steel	30	HSS+8%CO	White	DIN 1889 EA	0° 30' - 7° 7'	257

Articolo Article	Tipo Type	Campo d'applicazione Application field	Angolo elica Point Helix	Materiale tipo Tool material	Superficie Surface	Standard	Gamma dal diameter range	pag page
FRESE AD ANGOLO DOVETAIL CUTTERS								
 TCL 60 A	N	Acciai comuni Standard steel Acciai tenaci hardened steel	0	HSS+5%CO	White	DIN 1833 A/B	16 - 25	258
 TCL 60 B	N	Acciai comuni Standard steel Acciai tenaci hardened steel	0	HSS+5%CO	White	DIN 1833 A/B	16 - 25	258
FRESE PER SEDI DI LINGUETTE AMERICANE WOODRUFF WOODRUFF KEYSEAT CUTTERS								
 TCL 61	N	Acciai comuni Standard steel Acciai tenaci hardened steel	10	HSS+5%CO	White	DIN 850 B	10,5 - 45,50	259
FRESE PER SCANALATURA A " T " T-SLOT CUTTERS								
 TCL 62	N	Acciai comuni Standard steel Acciai tenaci hardened steel	12° - 15°	HSS+5%CO	White	DIN 851 AA	12,5 - 32	260
 TCM 63	N	Acciai comuni Standard steel Acciai tenaci hardened steel	12° - 15°	HSS+5%CO	White	DIN 851 B	22 - 56	261
FRESE A PROFILO CONCAVO AD UN QUARTO D CERCHIO QUARTER CIRCLE CUTTERS								
 RC 135	N	Acciai comuni Standard steel Acciai tenaci hardened steel	0	HSS+5%CO	White	DIN 6518 B	1 - 20	262
FRESE A DISCO A TRE TAGLIANTI DIRITTI E ALTERNATI SIDE AND FACE CUTTERS WITH STRAIGHT STAGGERED TEETH								
 CR 81	H	Acciai comuni Standard steel Acciai tenaci hardened steel	0	HSS+5%CO	White	DIN 885 B	50 - 160	263
 CR 83	N	Acciai comuni Standard steel Acciai tenaci hardened steel	8° - 15°	HSS+5%CO	White	DIN 885 A	50 - 250	265
FRESE SOTTILI A TAGLI ALTERNATI STUGGERED TEETH SAWS								
 CR 85	H	Acciai comuni Standard steel Acciai tenaci hardened steel	8° - 15°	HSS+5%CO	White	DIN 1834 A	63 - 160	268
FRESE FRONTALI AD ANGOLO ANGLE SHELL END MILLS								
 FA 91	H	Acciai comuni Standard steel Acciai tenaci hardened steel	0	HSS+5%CO	White	DIN 842 A	40 - 100	269
FRESE AD ANGOLO PRISMATICHE DOUBLE ANGLE CUTTERS								
 FP 92	H	Acciai comuni Standard steel Acciai tenaci hardened steel	0	HSS+5%CO	White	DIN 847	50 - 100	270

Articolo Article	Tipo Type	Campo d'applicazione Application field	Angolo elica Point Helix	Materiale tipo Tool material	Superficie Surface	Standard	Gamma dal diameter range	pag page
FRESE CILINDRICHE FRONTALI A SGROSSARE E FINIRE ROUGHING AND FINISHING SHELL END MILLS								
CF 94 	NR	Acciai comuni Standard steel Acciai tenaci hardened steel	30	HSS+8%CO	White	DIN 1880	40 - 160	271
CF 94 	NR	Acciai comuni Standard steel Acciai tenaci hardened steel	30	HSS+8%CO	Sapphire MULTI	DIN 1880	40 - 100	271
CF 94  resistor	NR	Acciai comuni Standard steel Acciai tenaci hardened steel	30	RESISTOR	White	DIN 1880	40 - 100	271
CF 94  resistor	NR	Acciai comuni Standard steel Acciai tenaci hardened steel	30	RESISTOR	Sapphire MULTI	DIN 1880	40 - 100	271
CF 95 	NF	Acciai comuni Standard steel Acciai tenaci hardened steel	30	HSS+8%CO	White	DIN 1880	40 - 100	271
CF 96 	N	Acciai comuni Standard steel Acciai tenaci hardened steel	20	HSS+8%CO	White	DIN 1880	40 - 100	272
CF 96 	N	Acciai comuni Standard steel Acciai tenaci hardened steel	20	HSS+8%CO	Sapphire MULTI	DIN 1880	40 - 100	272
CF 96  resistor	N	Acciai comuni Standard steel Acciai tenaci hardened steel	20	RESISTOR	White	DIN 1880	40 - 100	272
CF 96  resistor	N	Acciai comuni Standard steel Acciai tenaci hardened steel	20	RESISTOR	Sapphire MULTI	DIN 1880	40 - 100	272
CF 97 	W	Acciai comuni Standard steel Acciai tenaci hardened steel	40	HSS+5%CO	White	DIN 1880	40 - 125	272
CF 98 	N	Acciai comuni Standard steel Acciai tenaci hardened steel	30	HSS+8%CO	White	DIN 841	30 - 75	273
CF 99 	NR	Acciai comuni Standard steel Acciai tenaci hardened steel	30	HSS+8%CO	White	DIN 841	30 - 75	273
FRESE A DISCO PER DENTARE CREMAGLIERE ANGOLO DI PRESSIONE 20° RACK MILLING CUTTERS PRESSURE ANGLE 20°								
SCR 121 	N	Acciai comuni Standard steel Acciai tenaci hardened steel	0	HSS+5%CO	White	CARMON NORM	1 - 10	274
FRESE A PROFILO COSTANTE SEMICIRCOLARE CONVESSO CONVEX CUTTERS								
SCV 131 	N	Acciai comuni Standard steel Acciai tenaci hardened steel	0	HSS+5%CO	White	DIN 856	1 - 10	275
FRESE A PROFILO COSTANTE SEMICIRCOLARE CONCAVO CONCAVE CUTTERS								
SCC 132 	N	Acciai comuni Standard steel Acciai tenaci hardened steel	0	HSS+5%CO	White	DIN 855 A	1 - 10	276

Articolo Article	Tipo Type	Campo d'applicazione Application field	Angolo elica Point Helix	Materiale tipo Tool material	Superficie Surface	Standard	Gamma dal diameter range	pag page
FRESE A DISCO PER DENTARE INGRANAGGI CILINDRICI ANGOLO DI PRESSIONE 20° INVOLUTE GEAR CUTTERS 20° PRESSURE ANGLE								
MOD 141 	N	Acciai comuni Standard steel Acciai tenaci hardened steel	0	HSS+5%CO	White	UNI 4501	MOD 0,5 MOD 10 (DA 1 A 8)	277
PUNTE PER FORATURA A DUE DIAMETRI DI PROFILATI STEP MILLS								
ALL 156 	W	Alluminio aluminum	30	HSS+5%CO	White	CARMON NORM	6 - 6,5	278
FRESE A DUE TAGLIANTI PER LAVORARE PROFILATI PANTOGRAPH END MILLS								
ALL 157 	W	Alluminio aluminum	30	HSS+5%CO	White	CARMON NORM	4 - 6	278
FRESE MONOTAGLIANTI PER LAVORARE PROFILATI PANTOGRAPH END MILLS								
ALL 158 	W	Alluminio aluminum	30	HSS+5%CO	White	CARMON NORM	4 - 10	279
ALL 158 	W	Alluminio aluminum	30	HSS+5%CO	Sapphire MULTI	CARMON NORM	4 - 10	279
FRESE CILINDRICHE FRONTALI MULTIFLUTE CUTTERS								
ALL 160 resistor 	W	Alluminio aluminum	40	RESISTOR	White	DIN 844 B	6 - 32	280
ALL 164 resistor 	WR	Alluminio aluminum	35	RESISTOR	White	DIN 844 B	8 - 32	280
ALL 162 resistor 	W	Alluminio aluminum	40	RESISTOR	White	DIN 844 B	6 - 32	281
ALL 166 resistor 	WR	Alluminio aluminum	35	RESISTOR	White	DIN 844 B	10 - 32	281





rpm
= (mt/min x 1000) / (D x 3,14)



mm/min
= mm/rev x rpm



= mt/min



= mm/tooth

(vedi tabella - see table page pag. 230)

FRESE A CODOLO CILINDRICO STRAIGHT SHANK END MILLS

	SAPPHIRE MULTI		SAPPHIRE MULTI		SAPPHIRE MULTI		SAPPHIRE MULTI							
CL11				CL12				CL13F		CL18				
DIN 327/D				CARMON NORM.				DIN 327/H		DIN 327/D				
HSS+8%Co		RESISTOR		HSS+8%Co		RESISTOR		HSS+8%Co						

Pag. 378	TIPO DI ACCIAIO TYPE OF STEEL	N/mm ²	HV	mt/min mm/tooth	mt/min mm/tooth	mt/min mm/tooth	mt/min mm/tooth	mt/min mm/tooth	mt/min mm/tooth	mt/min mm/tooth	mt/min mm/tooth	mt/min mm/tooth	mt/min mm/tooth	mt/min mm/tooth
ACCIAI COMUNI COMMON STEEL	Acciai teneri Soft steel	1	500	157	60 b	120 b	75 b	130 a	60 b	120 b	75 b	130 a	60 b	40 t
	Acciai da costruzione Structural steel	2	700	219	50 b	100 b	65 b	120 b	50 b	100 b	65 b	120 b	50 b	28 t
	Acciai da tempra Hardening steel	3	900	280	12 c	45 c	35 c	70 c	12 c	45 c	35 c	70 c	12 c	24 t
	Acciaio automatico Automatic steel	4	1200	373		14 d		25 c		14 d		25 c		
ACCIAI INOX STAINLESS STEEL	Acciaio automatico Automatic steel	3	850	265	25 e	35 e	40 c	80 c	25 e	35 e	40 c	80 c	25 e	25 e
	Austenitico Austenitic	3	850	265		22 g	35 c	70 c		22 g	35 c	70 c		
	Ferritico+austenitico Ferritic austenitic	4	1000	311				20 b				20 b		
GHISA CAST IRON	Ghisa fino a 180 hb Cast iron up to 180 hb	2	500	157	30 b	50 b	35 r	58 r	30 b	50 b	35 r	58 r	30 b	30 b
	Ghisa oltre 180 hb Cast iron over 180 hb	3	700	219	25 b	45 b	30 r	45 r	25 b	45 b	30 r	45 r	25 b	25 b
TITANIO TITANIUM	Titanio non legato Unalloyed titanium	5	500	157	30 e	38 e	35 e	45 e	30 e	38 e	35 e	45 e	30 e	30 e
	Leghe di titanio Titanium alloys	5	900	280	25 e	33 e	28 e	38 e	25 e	33 e	28 e	38 e	25 e	25 e
RAME COPPER	Rame Copper	9	350	110	135 c	215 c	150 d	260 d	135 c	215 c	150 d	260 d	135 c	135 c
	Ottone Brass	9	700	219	140 c	220 c	160 d	270 d	140 c	220 c	160 d	270 d	140 c	140 c
	Bronzo Bronze	9	700	219	140 c	220 c	160 d	270 d	140 c	220 c	160 d	270 d	140 c	140 c
NICHEL NICKEL	Nichel non legato Unalloyed nichel	6	700	219	50 e	100 e	55 s	125 s	50 e	100 e	55 s	125 s	50 e	50 e
	Leghe di nichel Nichel alloys	6	900	280	15 b	25 b	18 s	35 s	15 b	25 b	18 s	35 s	15 b	15 b
ALLUMINIO ALUMINIUM	Alluminio non legato Unalloyed aluminium	7	350	110	330 f	660 f	350 r	700 r	330 f	660 f	350 r	700 r	330 f	330 f
	Alluminio con leghe Alloyed aluminium	7	400	125	330 f	660 f	350 r	700 r	330 f	660 f	350 r	700 r	330 f	330 f
	Alluminio con leghe Alloyed aluminium	7	500	157	100 f	200 f	120 r	240 r	100 f	200 f	120 r	240 r	100 f	100 f

FRESE A CODOLO CILINDRICO STRAIGHT SHANK END MILLS

CL19		CL16				CL30FE	CL17		CL21TF				CL22TF	
CARMON NORM.		DIN 844/B												
HSS+8%Co		RESISTOR			HSS+8%Co				RESISTOR			HSS+8%Co		
mt/min mm/tooth		mt/min mm/tooth			mt/min mm/tooth				mt/min mm/tooth			mt/min mm/tooth		
40 t	50 a	100 a	60 b	120 b	50 a	50 a	50 a	100 a	60 b	120 b	120 b	50 a	100 a	
28 t	40 a	80 a	50 b	100 b	40 a	40 a	40 a	80 a	50 b	100 b	100 b	40 a	80 a	
24 t	28 n	60 b	40 c	80 c	28 n	28 n	28 n	60 b	40 c	80 c	80 c	28 n	60 b	
		35 d		38 c				35 d		38 c	38 c		35 d	
25 e	20 e	34 e	28 e	45 e	20 e	20 e	20 e	34 e	28 e	45 e	45 e	20 e	34 e	
	15 e	25 e	20 e	35 e	15 e	15 e	15 e	25 e	20 e	35 e	35 e	15 e	25 e	
	8 d	18 e	12 e	23 e	8 d	8 d	8 d	18 e	12 e	23 e	23 e	8 d	18 e	
30 b	30 b	50 b	35 r	58 r	30 b	30 b	30 b	50 b	35 r	58 r	58 r	30 b	50 b	
25 b	25 b	45 b	30 r	45 r	25 b	25 b	25 b	45 b	30 r	45 r	45 r	25 b	45 b	
30 e	30 e	38 e	35 e	45 e	30 e	30 e	30 e	38 e	35 e	45 e	45 e	30 e	38 e	
25 e	25 e	33 e	28 e	38 e	25 e	25 e	25 e	33 e	28 e	38 e	38 e	25 e	33 e	
135 c	135 c	215 c	150 d	260 d	135 c	135 c	135 c	215 c	150 d	260 d	260 d	135 c	215 c	
140 c	140 c	220 c	160 d	270 d	140 c	140 c	140 c	220 c	160 d	270 d	270 d	140 c	220 c	
140 c	140 c	220 c	160 d	270 d	140 c	140 c	140 c	220 c	160 d	270 d	270 d	140 c	220 c	
50 e	50 e	100 e	55 s	125 s	50 e	50 e	50 e	100 e	55 s	125 s	125 s	50 e	100 e	
15 b	15 b	25 b	18 s	35 s	15 b	15 b	15 b	25 b	18 s	35 s	35 s	15 b	25 b	
330 f	330 f	660 f	350 r	700 r	660 f	330 f	330 f	660 f	350 r	700 r	700 r	330 f	660 f	
330 f	330 f	660 f	350 r	700 r	660 f	330 f	330 f	660 f	350 r	700 r	700 r	330 f	660 f	
100 f	100 f	200 f	120 r	240 r	200 f	100 f	100 f	200 f	120 r	240 r	240 r	100 f	200 f	



rpm
= (mt/min x 1000) / (D x 3,14)



mm/min
= mm/rev x rpm



= mt/min









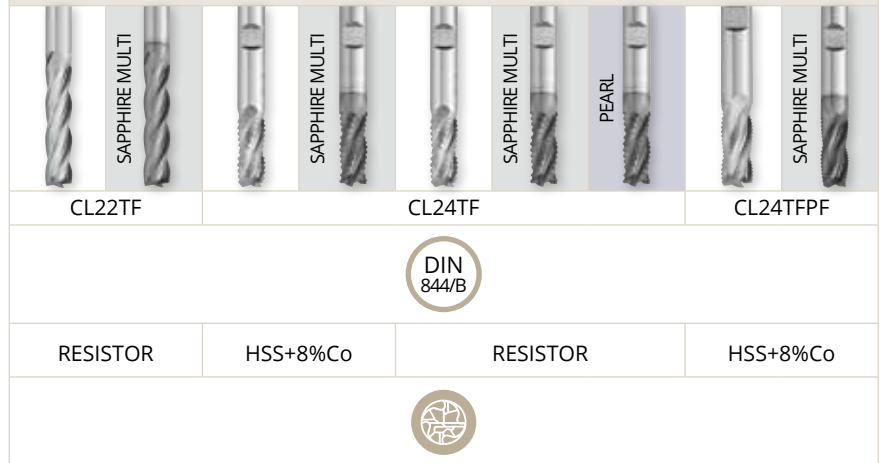





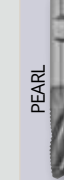



= mm/tooth

(vedi tabella - see table page pag. 230)

FRESE A CODOLO CILINDRICO STRAIGHT SHANK END MILLS



Pag. 378	TIPO DI ACCIAIO TYPE OF STEEL	N/mm ²	HV	mt/min mm/tooth	mt/min mm/tooth	mt/min mm/tooth	mt/min mm/tooth	mt/min mm/tooth	mt/min mm/tooth	mt/min mm/tooth	mt/min mm/tooth	mt/min mm/tooth	mt/min mm/tooth
ACCIAI COMUNI COMMON STEEL	Acciai teneri Soft steel	1	500	157	60 b	120 b	50 s	100 s	60 r	120 r	120 b	50 s	100 s
	Acciai da costruzione Structural steel	2	700	219	50 b	100 b	40 s	80 s	50 r	100 r	100 b	40 s	80 s
	Acciai da tempra Hardening steel	3	900	280	40 c	80 c	28 s	60 s	40 r	80 r	80 c	28 s	60 s
	Acciaio automatico Automatic steel	4	1200	373		38 c		35 s		38 r	38 c		35 s
ACCIAI INOX STAINLESS STEEL	Acciaio automatico Automatic steel	3	850	265	28 e	45 e	25 r	35 r	30 r	45 r	45 e	25 r	35 r
	Austenitico Austenitic	3	850	265	20 e	35 e			28 r	40 r	35 e		
	Ferritico+austenitico Ferritic austenitic	4	1000	311	12 e	23 e		18 i	15 r	25 r	23 e		18 i
GHISA CAST IRON	Ghisa fino a 180 hb Cast iron up to 180 hb	2	500	157	35 r	58 r	27 m	45 m	32 m	50 m	50 m	27 m	45 m
	Ghisa oltre 180 hb Cast iron over 180 hb	3	700	219	30 r	45 r	22 m	40 m	27 m	45 m	45 m	22 m	40 m
TITANIO TITANIUM	Titanio non legato Unalloyed titanium	5	500	157	35 e	45 e	32 h	40 h	35 m	45 m	45 m	32 h	40 h
	Leghe di titanio Titanium alloys	5	900	280	28 e	38 e	28 h	36 h	30 m	40 m	40 m	28 h	36 h
RAME COPPER	Rame Copper	9	350	110	150 d	260 d	140 s	220 s	155 s	235 s	235 s	140 s	220 s
	Ottone Brass	9	700	219	160 d	270 d	150 s	225 s	160 s	230 s	230 s	150 s	225 s
	Bronzo Bronze	9	700	219	160 d	270 d	150 s	225 s	160 s	230 s	230 s	150 s	225 s
NICHEL NICKEL	Nichel non legato Unalloyed nichel	6	700	219	55 s	125 s	55 u	110 u	65 u	120 u	120 u	55 u	110 u
	Leghe di nichel Nichel alloys	6	900	280	18 s	35 s	20 u	30 u	30 u	60 u	60 u	20 u	30 u
ALLUMINIO ALUMINIUM	Alluminio non legato Unalloyed aluminium	7	350	110	350 r	700 r	330 u	660 u	350 u	700 u	700 u	330 u	660 u
	Alluminio con leghe Alloyed aluminium	7	400	125	350 r	700 r	330 u	660 u	350 u	700 u	700 u	330 u	660 u
	Alluminio con leghe Alloyed aluminium	7	500	157	120 r	240 r	100 u	200 u	100 u	200 u	200 u	100 u	200 u

FRESE A CODOLO CILINDRICO STRAIGHT SHANK END MILLS									FRESE A CODOLO CONICO MORSE TAPER SHANK END MILLS								
																	
CL24TFPF			CL24SLTF			CL24SLTFPF			CL25TF			CM31	CM36	CM37FE	CM38	CM41TF	
																	
RESISTOR			HSS+8%Co						HSS+8%Co								
																	
mt/min mm/tooth	mt/min mm/tooth	mt/min mm/tooth	mt/min mm/tooth	mt/min mm/tooth	mt/min mm/tooth	mt/min mm/tooth	mt/min mm/tooth	mt/min mm/tooth	mt/min mm/tooth	mt/min mm/tooth	mt/min mm/tooth	mt/min mm/tooth	mt/min mm/tooth	mt/min mm/tooth	mt/min mm/tooth		
60 r	120 r	120 b	50 s	100 s	50 s	100 s	50 s	100 s	60 b	50 a	50 a	50 i	50 a	100 a			
50 r	100 r	100 b	40 s	80 s	40 s	80 s	40 s	80 s	50 b	40 a	40 a	40 i	40 a	80 a			
40 r	80 r	80 c	28 s	60 s	28 s	60 s	28 s	60 s	12 c	28 n	28 n	28 i	28 n	56 n			
	38 r	38 c		35 s		35 s		35 s						35 d			
30 r	45 r	45 r	25 r	35 r	25 r	35 r	25 r	35 r	25 e	20 e	20 e	20 g	20 e	34 e			
28 r	40 r	40 r								15 e	15 e	15 g	15 e	25 e			
15 r	25 r	25 r		18 i		18 i		18 i		8 d	8 d	8 i	8 d	18 d			
32 m	50 m	50 m	27 m	45 m	27 m	45 m	27 m	45 m	30 b	30 b	30 b	30 i	30 b	50 b			
27 m	45 m	45 m	22 m	40 m	22 m	40 m	22 m	40 m	25 b	25 b	25 b	25 i	25 b	45 b			
35 m	45 m	40 h	32 h	40 h	32 h	40 h	32 h	40 h	30 e	30 e	30 e	30 g	30 e	38 e			
30 m	40 m	36 h	28 h	36 h	28 h	36 h	28 h	36 h	25 e	25 e	25 e	25 g	25 e	33 e			
155 s	235 s	235 s	140 s	220 s	140 s	220 s	140 s	220 s	135 c	135 c	135 c	135 i	135 c	215 c			
160 s	230 s	230 s	150 s	225 s	150 s	225 s	150 s	225 s	140 c	140 c	140 c	140 i	140 c	220 c			
160 s	230 s	230 s	150 s	225 s	150 s	225 s	150 s	225 s	140 c	140 c	140 c	140 i	140 c	220 c			
65 u	120 u	120 u	55 u	110 u	55 u	110 u	55 u	110 u	50 e	50 e	50 e	50 g	50 e	100 e			
30 u	60 u	60 u	20 u	30 u	20 u	30 u	20 u	30 u	15 b	15 b	15 b	15 i	15 b	25 b			
350 u	700 u	700 u	330 u	660 u	330 u	660 u	330 u	660 u	330 f	330 f	660 f	330 i	330 f	660 f			
350 u	700 u	700 u	330 u	660 u	330 u	660 u	330 u	660 u	330 f	330 f	660 f	330 i	330 f	660 f			
100 u	200 u	200 u	100 u	200 u	100 u	200 u	100 u	200 u	100 f	100 f	200 f	100 i	100 f	200 f			



rpm
= (mt/min x 1000) / (D x 3,14)



mm/min
= mm/rev x rpm



= mt/min



= mm/tooth



















(vedi tabella - see table page pag. 230)

FRESE A CODOLO CONICO MORSE TAPER SHANK END MILLS

	SAPPHIRE MULTI						
CM41TF		CM41R	CM44R	CM42			
DIN 845/B		DIN 1889/2D		DIN 845/B			
RESISTOR		HSS+8%Co					

Pag. 378	TIPO DI ACCIAIO TYPE OF STEEL	N/mm ²	HV	mt/min mm/tooth	mt/min mm/tooth	mt/min mm/tooth	mt/min mm/tooth	mt/min mm/tooth	mt/min mm/tooth	mt/min mm/tooth	mt/min mm/tooth	mt/min mm/tooth
ACCIAI COMUNI COMMON STEEL	Acciai teneri Soft steel	1	500	157	60 b	120 b	50 a	50 s	50 g	100 g	60 b	120 b
	Acciai da costruzione Structural steel	2	700	219	50 b	100 b	40 a	40 s	40 g	80 g	50 b	100 b
	Acciai da tempra Hardening steel	3	900	280	40 c	80 c	28 n	28 s	28 i	56 i	40 c	80 c
	Acciaio automatico Automatic steel	4	1200	373		38 c				35 d		38 c
ACCIAI INOX STAINLESS STEEL	Acciaio automatico Automatic steel	3	850	265	28 e	45 e	20 e	25 r	20 c	34 c	28 e	45 e
	Austenitico Austenitic	3	850	265	20 e	35 e	15 e		15 c	25 c	20 e	35 e
	Ferritico+austenitico Ferritic austenitic	4	1000	311	12 e	23 e	8 d		8 i	18 i	12 e	23 e
GHISA CAST IRON	Ghisa fino a 180 hb Cast iron up to 180 hb	2	500	157	35 r	58 r	30 b	27 m	30 i	50 i	35 r	58 r
	Ghisa oltre 180 hb Cast iron over 180 hb	3	700	219	30 r	45 r	25 b	22 m	25 i	45 i	30 r	45 r
TITANIO TITANIUM	Titanio non legato Unalloyed titanium	5	500	157	35 e	45 e	30 e	32 h	30 c	38 c	35 e	45 e
	Leghe di titanio Titanium alloys	5	900	280	28 e	38 e	25 e	28 h	25 c	33 c	28 e	38 e
RAME COPPER	Rame Copper	9	350	110	150 d	260 d	135 c	140 s	135 h	215 h	150 d	260 d
	Ottone Brass	9	700	219	160 d	270 d	140 c	150 s	140 h	220 h	160 d	270 d
	Bronzo Bronze	9	700	219	160 d	270 d	140 c	150 s	140 h	220 h	160 d	270 d
NICHEL NICKEL	Nichel non legato Unalloyed nichel	6	700	219	55 s	125 s	50 e	55 u	50 c	100 c	55 s	125 s
	Leghe di nichel Nichel alloys	6	900	280	18 s	35 s	15 b	20 u	15 i	25 i	18 s	35 s
ALLUMINIO ALUMINIUM	Alluminio non legato Unalloyed aluminium	7	350	110	350 r	700 r	330 f	330 u	330 h	660 h	350 r	700 r
	Alluminio con leghe Alloyed aluminium	7	400	125	350 r	700 r	330 f	330 u	330 h	660 h	350 r	700 r
	Alluminio con leghe Alloyed aluminium	7	500	157	120 r	240 r	100 f	100 u	100 h	200 h	120 r	240 r

FRESE A CODOLO CONICO MORSE TAPER SHANK END MILLS

FRESE A CODOLO CONICO MORSE TAPER SHANK END MILLS												
												
CM42R	CM48R	CM43	CM44TF				CM48				CM45TF	
												
HSS+8%Co				RESISTOR				HSS+8%Co		RESISTOR		HSS+8%Co
												
mt/min mm/tooth	mt/min mm/tooth	mt/min mm/tooth	mt/min mm/tooth	mt/min mm/tooth	mt/min mm/tooth	mt/min mm/tooth	mt/min mm/tooth	mt/min mm/tooth	mt/min mm/tooth	mt/min mm/tooth	mt/min mm/tooth	
50 g	50 g	25 m	50 s	100 s	60 r	120 r	50 g	100 g	60 r	120 r	50 s	
40 g	40 g	18 m	40 s	80 s	50 r	100 r	40 g	80 g	50 r	100 r	40 s	
28 i	28 g	12 m	28 s	56 s	40 r	80 r	28 g	56 g	40 r	80 r	28 s	
		10 m		35 s		38 r		35 s		38 r		
20 c	25 h		25 r	35 r	30 r	45 r	25 h	35 h	30 r	45 r	25 r	
15 c					28 r	40 r			28 r	40 r		
8 i				18 i	15 r	25 r		18 i	15 r	25 r		
30 i	27 m		27 m	45 m	32 m	50 m	27 m	45 m	32 m	50 m	27 m	
25 i	22 m	16 m	22 m	40 m	27 m	45 m	22 m	40 m	27 m	45 m	22 m	
30 c	32 h		32 h	40 h	35 m	45 m	32 h	40 h	35 m	45 m	32 h	
25 c	28 h		28 h	36 h	30 m	40 m	28 h	36 h	30 m	40 m	28 h	
135 h	140 o		140 s	220 s	155 s	235 s	140 o	220 o	155 s	235 s	140 s	
140 h	150 o		150 s	225 s	160 s	230 s	150 o	225 o	160 s	230 s	150 s	
140 h	150 o		150 s	225 s	160 s	230 s	150 o	225 o	160 s	230 s	150 s	
50 c	55 i		55 u	110 u	65 u	120 u	55 i	110 i	65 u	120 u	55 u	
15 i	20 i		20 u	30 u	30 u	60 u	20 i	30 i	30 u	60 u	20 u	
330 h	330 i	150 m	330 u	660 u	350 u	700 u	330 i	660 i	350 u	700 u	330 u	
330 h	330 i		330 u	660 u	350 u	700 u	330 i	660 i	350 u	700 u	330 u	
100 h	100 i		100 u	200 u	100 u	200 u	100 i	200 i	100 u	200 u	100 u	



rpm
= (mt/min x 1000) / (D x 3,14)



mm/min
= mm/rev x rpm



= mt/min











= mm/tooth

(vedi tabella - see table page pag. 230)

Pag. 378	TIPO DI ACCIAIO TYPE OF STEEL	N/mm ²	HV	UTENSILI VARI VARIOUS CUTTING TOOLS						FRESE A DISCO, AD ANGOLO E FRONTALI SIDE AND FACE CUTTER, ANGLE CUTTER, SHELL END MILLS					
				DIN 1889/EA	DIN 1833A/B	DIN 850/B	DIN 851AA	DIN 851/B	DIN 6518/B	DIN 885/B	DIN 885/A				
HSS+5%Co															
				mt/min mm/tooth	mt/min mm/tooth	mt/min mm/tooth	mt/min mm/tooth	mt/min mm/tooth	mt/min mm/tooth	mt/min mm/tooth	mt/min mm/tooth	mt/min mm/tooth	mt/min mm/tooth	mt/min mm/tooth	
ACCIAI COMUNI COMMON STEEL	Acciai teneri Soft steel	1	500	157	50 a	35 f	30 c	35 c	35 c	50 a	40 i	40 c	40 i		
	Acciai da costruzione Structural steel	2	700	219	40 a	30 f	25 c	30 c	30 c	40 a	35 i	35 c	35 i		
	Acciai da tempra Hardening steel	3	900	280	28 n	25 e	20 b	25 b	25 b	28 n	30 i	30 c	30 i		
	Acciaio automatico Automatic steel	4	1200	373		15 d	10 b	15 b	15 b		20 i	20 c	20 i		
ACCIAI INOX STAINLESS STEEL	Acciaio automatico Automatic steel	3	850	265	20 e	18 d	15 c	18 c	18 c	20 e	25 i	25 c	25 i		
	Austenitico Austenitic	3	850	265	15 e	15 c	10 b	15 b	15 b	15 e	20 i	20 c	20 i		
	Ferritico+austenitico Ferritic austenitic	4	1000	311	8 d	10 b	10 a	10 a	10 a	8 d	10 i	10 c	10 i		
GHISA CAST IRON	Ghisa fino a 180 hb Cast iron up to 180 hb	2	500	157	30 b	20 e	20 b	20 b	20 b	30 b	25 c	25 d	25 c		
	Ghisa oltre 180 hb Cast iron over 180 hb	3	700	219	25 b	15 c	15 b	15 b	15 b	25 b	15 c	15 d	15 c		
TITANIO TITANIUM	Titanio non legato Unalloyed titanium	5	500	157	30 e	25 e	30 c	25 b	25 b	30 e	25 c	25 a	25 c		
	Leghe di titanio Titanium alloys	5	900	280	25 e	15 c	20 b	15 b	15 b	25 e	15 i	15 b	15 i		
RAME COPPER	Rame Copper	9	350	110	135 c	75 f	25 c	90 d	90 d	135 c	120 i	120 c	120 i		
	Ottone Brass	9	700	219	140 c	75 f	25 c	90 d	90 d	140 c	120 i	120 c	120 i		
	Bronzo Bronze	9	700	219	140 c	65 f	35 c	35 c	35 c	140 c	120 i	120 c	120 i		
NICHEL NICKEL	Nichel non legato Unalloyed nichel	6	700	219	50 e	20 d	30 c	25 b	25 b	50 e	35 i	35 c	35 i		
	Leghe di nichel Nichel alloys	6	900	280	15 b	12 c	6 a	6 a	6 a	15 b	12 c	12 b	12 c		
ALLUMINIO ALUMINIUM	Alluminio non legato Unalloyed aluminium	7	350	110	330 f	150 i	60 h	150 i	150 i	330 f	350 c	350 d	350 c		
	Alluminio con leghe Alloyed aluminium	7	400	125	330 f	55 h	30 d	55 h	55 h	330 f	100 c	100 d	100 c		
	Alluminio con leghe Alloyed aluminium	7	500	157	100 f	40 g	15 b	40 g	40 g	100 f	70 c	70 d	70 c		

FRESE A DISCO, AD ANGOLO E FRONTALI
SIDE AND FACE CUTTER, ANGLE CUTTER, SHELL END MILLS

				 SAPPHIRE MULTI		 SAPPHIRE MULTI		 SAPPHIRE MULTI		 SAPPHIRE MULTI					
FA91	FP92	CF94				CF95	CF96				CF97	CF98	CF99		
DIN 842/A	DIN 847	DIN 1880										DIN 841			
HSS+5%Co		HSS+8%Co		RESISTOR		HSS+8%Co		RESISTOR		HSS+5%Co		HSS+8%Co			
mt/min mm/tooth	mt/min mm/tooth	mt/min mm/tooth	mt/min mm/tooth	mt/min mm/tooth	mt/min mm/tooth	mt/min mm/tooth	mt/min mm/tooth	mt/min mm/tooth	mt/min mm/tooth	mt/min mm/tooth	mt/min mm/tooth	mt/min mm/tooth	mt/min mm/tooth		
35 m	35 m	30 d	60 d	35 t	70 t	30 d	30 d	60 d	35 t	70 t		30 d	30 d		
14 m	14 m	25 d	50 d	30 t	60 t	25 d	25 d	50 d	30 t	60 t		25 d	25 d		
11 m	11 m	20 c	40 d	25 p	50 p	20 c	20 c	40 d	25 p	50 p		20 c	20 c		
9 m	9 m	10 b	20 b	14 r	28 r	10 b	10 b	20 b	14 r	28 r		10 b	10 b		
14 m	14 m	20 c	40 c	20 b	40 b	20 c	20 c	40 c	20 b	40 b		20 c	20 c		
12 m	12 m	15 c	30 c	15 n	30 n	15 c	15 c	30 c	15 n	30 n		15 c	15 c		
10 m	10 m	6 a	12 a	8 r	16 r	6 a	6 a	12 a	8 r	16 r		6 a	6 a		
25 m	25 m	20 b	40 b	25 d	50 d	20 b	20 b	40 b	25 d	50 d		20 b	20 b		
20 m	20 m	15 b	30 b	20 d	40 d	15 b	15 b	30 b	20 d	40 d		15 b	15 b		
		30 c	30 c	35 d	70 d	30 c	30 c	30 c	35 d	70 d		30 c	30 c		
		20 b	40 b	25 a	50 a	20 b	20 b	40 b	25 a	50 a		20 b	20 b		
		70 g	140 g	80 f	160 f	70 g	70 g	140 g	80 f	160 f		70 g	70 g		
		70 g	140 g	80 f	160 f	70 g	70 g	140 g	80 f	160 f		70 g	70 g		
		35 f	70 f	40 b	80 b	35 f	35 f	70 f	40 b	80 b		35 f	35 f		
		30 c	60 c	35 d	70 d	30 c	30 c	60 c	35 d	70 d		30 c	30 c		
		12 a	24 a	15 a	30 a	12 a	12 a	24 a	15 a	30 a		12 a	12 a		
85 m	85 m	200 h	400 h	230 i	450 i	200 h					200 d	200 h	200 h		
		60 d	120 d	80 d	160 d	60 d					120 d	60 d	60 d		
		35 d	70 d	40 d	80 d	35 d					80 d	35 d	35 d		



rpm
= (mt/min x 1000) / (D x 3,14)



mm/min
= mm/rev x rpm



= mt/min



= mm/tooth

(vedi tabella - see table page pag. 230)

FRESE A DISCO, AD ANGOLO E FRONTALI SIDE AND FACE CUTTER, ANGLE CUTTER, SHELL END MILLS



SCR121



SCV131



SCC132





MOD141



HSS+5%Co

Pag. 378	TIPO DI ACCIAIO TYPE OF STEEL		N/mm ²	HV	mt/min mm/tooth	mt/min mm/tooth	mt/min mm/tooth	mt/min mm/tooth
ACCIAI COMUNI COMMON STEEL	Acciai teneri Soft steel	1	500	157	25 m	25 m	25 m	25 m
	Acciai da costruzione Structural steel	2	700	219	14 m	14 m	14 m	14 m
	Acciai da tempra Hardening steel	3	900	280	11 m	11 m	11 m	11 m
	Acciaio automatico Automatic steel	4	1200	373	9 m	9 m	9 m	9 m
ACCIAI INOX STAINLESS STEEL	Acciaio automatico Automatic steel	3	850	265	14 m	14 m	14 m	14 m
	Austenitico Austenitic	3	850	265	12 m	12 m	12 m	12 m
	Ferritico+austenitico Ferritic austenitic	4	1000	311	10 m	10 m	10 m	10 m
GHISA CAST IRON	Ghisa fino a 180 hb Cast iron up to 180 hb	2	500	157	25 m	25 m	25 m	25 m
	Ghisa oltre 180 hb Cast iron over 180 hb	3	700	219	20 m	20 m	20 m	20 m
TITANIO TITANIUM	Titanio non legato Unalloyed titanium	5	500	157				
	Leghe di titanio Titanium alloys	5	900	280				
RAME COPPER	Rame Copper	9	350	110				
	Ottone Brass	9	700	219				
	Bronzo Bronze	9	700	219				
NICHEL NICKEL	Nichel non legato Unalloyed nichel	6	700	219				
	Leghe di nichel Nichel alloys	6	900	280				
ALLUMINIO ALUMINIUM	Alluminio non legato Unalloyed aluminium	7	350	110	85 m	85 m	85 m	85 m
	Alluminio con leghe Alloyed aluminium	7	400	125				
	Alluminio con leghe Alloyed aluminium	7	500	157				

UTENSILI PER PROFILATI D'ALLUMINIO, PVC E LEGHE LEGGERE
CUTTING TOOLS FOR ALUMINIUM PROFILES,
PLASTIC AND LIGHT ALLOYS

SAPPHIRE MULTI							
ALL156	ALL157	ALL158		ALL160	ALL162	ALL164	ALL166
CARMON NORM.				DIN 844/B			
HSS+5%Co				RESISTOR			
							
mt/min mm/tooth	mt/min mm/tooth	mt/min mm/tooth	mt/min mm/tooth	mt/min mm/tooth	mt/min mm/tooth	mt/min mm/tooth	mt/min mm/tooth
				60 b	60 b	60 r	60 r
				50 b	50 b	50 r	50 r
				40 c	40 c	40 r	40 r
				28 e	28 e	30 r	30 r
				20 e	20 e	28 r	28 r
				12 e	12 e	15 r	15 r
				35 r	35 r	32 m	32 m
				30 r	30 r	27 m	27 m
				35 e	35 e	35 m	35 m
				28 e	28 e	30 m	30 m
				150 d	150 d	155 s	155 s
				160 d	160 d	160 s	160 s
				160 d	160 d	160 s	160 s
				55 s	55 s	110 u	110 u
				18 s	18 s	30 u	30 u
100 c	100 c	200 v	400 v	350 r	350 r	350 u	350 u
				350 r	350 r	350 u	350 u
				120 r	120 r	100 u	100 u

FRESATURA MILLING		TABELLA PARAMETRI DI AVANZAMENTO mm/dente FEED DATA mm/tooth.																
		DIAMETRO DELLA FRESA MILLING DIAMETER																
TIPO DI FRESATURA TYPE OF MILLING	LETTERA DI RIFERIMENTO REFERENCE LETTER	D.1	D.2	D.3	D.4	D.5	D.6	D.8	D.10	D.12	D.14	D.16	D.20	D.25	D.30	D.35	D.40	D.50
FRESATURA DI CAVE SLOTING	a	0,005	0,010	0,015	0,020	0,025	0,030	0,045	0,060	0,075	0,085	0,095	0,100	0,102	0,110	0,107	0,106	0,108
	b	0,005	0,008	0,013	0,017	0,023	0,027	0,040	0,056	0,065	0,074	0,085	0,087	0,089	0,100	0,098	0,096	0,098
	c	0,004	0,007	0,012	0,016	0,021	0,022	0,034	0,050	0,057	0,067	0,079	0,080	0,082	0,085	0,088	0,087	0,089
	d	0,004	0,008	0,010	0,014	0,020	0,025	0,036	0,052	0,063	0,072	0,083	0,084	0,086	0,092	0,098	0,100	0,102
	e	0,008	0,010	0,019	0,025	0,036	0,043	0,062	0,087	0,106	0,125	0,145	0,147	0,149	0,173	0,156	0,168	0,177
	f	0,008	0,010	0,015	0,020	0,022	0,024	0,035	0,042	0,054	0,056	0,067	0,079	0,086	0,089	0,091	0,091	0,091
SGROSSATURA ROUGHING	g						0,027	0,036	0,037	0,045	0,053	0,057	0,074	0,075	0,055	0,057	0,056	0,056
	h						0,024	0,033	0,034	0,039	0,046	0,051	0,065	0,067	0,050	0,051	0,049	0,052
	i						0,022	0,031	0,034	0,040	0,045	0,054	0,063	0,065	0,050	0,055	0,056	0,060
	l						0,025	0,036	0,048	0,064	0,080	0,093	0,105	0,100	0,102	0,112	0,115	0,120
	m						0,026	0,011	0,014	0,018	0,022	0,027	0,030	0,033	0,036	0,040	0,043	0,045
SEMI FINITURA SEMI-FINISHING	n	0,008	0,012	0,017	0,023	0,030	0,036	0,052	0,061	0,073	0,083	0,106	0,083	0,078	0,084	0,089	0,095	0,100
	o	0,007	0,010	0,016	0,020	0,027	0,025	0,047	0,055	0,066	0,074	0,090	0,074	0,070	0,075	0,080	0,900	0,950
	p	0,080	0,011	0,018	0,021	0,029	0,029	0,050	0,060	0,070	0,080	0,099	0,082	0,075	0,080	0,085	0,095	0,101
	q	0,008	0,015	0,022	0,025	0,037	0,035	0,067	0,080	0,094	0,107	0,100	0,095	0,113	0,120	0,128	0,140	0,147
	r	0,013	0,017	0,020	0,026	0,030	0,030	0,048	0,057	0,063	0,075	0,095	0,094	0,092	0,093	0,105	0,108	0,115
FINITURA FINISHING	s	0,011	0,016	0,025	0,030	0,040	0,038	0,073	0,088	0,102	0,115	0,146	0,114	0,108	0,115	0,125	0,138	0,143
	t	0,008	0,013	0,022	0,025	0,036	0,036	0,047	0,066	0,078	0,093	0,105	0,130	0,104	0,098	0,105	0,112	0,128
	u	0,009	0,014	0,020	0,025	0,030	0,042	0,060	0,072	0,083	0,093	0,114	0,098	0,089	0,095	0,100	0,110	0,118
	v	0,012	0,018	0,025	0,034	0,046	0,048	0,060	0,083	0,100	0,116	0,135	0,122	0,140	0,149	0,155	0,178	0,180
	z	0,016	0,022	0,027	0,033	0,038	0,048	0,061	0,073	0,083	0,094	0,115	0,117	0,118	0,135	0,137	0,140	0,143

Carmon

CL 11

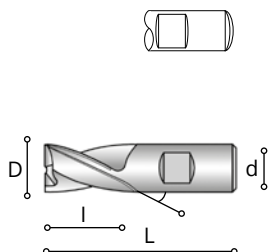

CL11



D e8	L	I	d h6	Z	CODE	HSS+8%Co 1110..... €	HSS+8%Co 2110..... € SAPPHIRE MULTI	CODE	RESISTOR 1110..... €	RESISTOR 2110..... € SAPPHIRE MULTI
1	47	2,5	6	2	...01000	23,87	30,92			
1,5	47	3	6	2	...01500	22,24	29,13			
2	48	4	6	2	...02000	19,91	26,57	...02030	23,16	30,15
2,5	49	5	6	2	...25000	19,91	26,57			
3	49	5	6	2	...30000	16,93	23,29	...30030	19,43	26,03
3,5	50	6	6	2	...35000	16,93				
4	51	7	6	2	...40000	16,43	22,75	...40030	18,90	25,45
4,5	51	7	6	2	...45000	17,01				
5	52	8	6	2	...50000	16,15	22,43	...50030	18,62	25,16
5,5	52	8	6	2	...55000	16,43				
6	52	8	6	2	...60000	15,20	21,38	...60030	17,94	24,47
6,5	60	10	10	2	...65000	21,67				
7	60	10	10	2	...70000	22,10	31,21	...70030	25,66	35,09
7,5	60	10	10	2	...75000	22,17				
8	61	11	10	2	...80000	20,77	29,60	...80030	24,00	33,18
8,5	61	11	10	2	...85000	25,15				
9	61	11	10	2	...90000	24,98	34,40	...90030	29,17	38,64
9,5	61	11	10	2	...95000	25,28				
10	63	13	10	2	...10000	23,52	32,64	...10030	27,36	36,86
10,5	70	13	12	2	...10500	30,31				
11	70	13	12	2	...11000	29,04	38,70	...11030	33,85	44,00
11,5	70	13	12	2	...11500	30,02				
12	73	16	12	2	...12000	29,15	38,82	...12030	34,32	44,62
12,5	73	16	12	2	...12500	32,43				
13	73	16	12	2	...13000	32,43	43,07	...13030	38,87	50,38
13,5	73	16	12	2	...13500	35,89				
14	73	16	12	2	...14000	34,84	45,71	...14030	41,68	53,35
14,5	73	16	12	2	...14500	39,75				
15	73	16	12	2	...15000	39,75	50,47	...15030	46,49	58,65
15,5	79	19	16	2	...15500	42,33				
16	79	19	16	2	...16000	41,70	53,26	...16030	48,92	61,22
17	79	19	16	2	...17000	47,59	63,43	...17030	65,08	82,66
18	79	19	16	2	...18000	52,86	69,24	...18030	65,08	82,66
19	79	19	16	2	...19000	65,34	85,17	...19030	81,65	103,09
20	88	22	20	2	...20000	62,21	81,44	...20030	75,15	95,88
22	88	22	20	2	...22000	82,78	104,06	...22030	100,36	123,42
24	102	26	25	2	...24000	120,00	155,65	...24030	149,46	188,05
25	102	26	25	2	...02500	120,00	155,65	...25030	151,70	190,87
26	102	26	25	2	...26000	131,65				
28	102	26	25	2	...28000	139,48				

CL 11

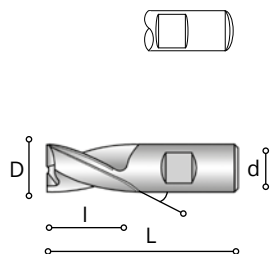

CL11



D e8	L	I	d h6	Z	CODE	HSS+8%Co	HSS+8%Co	CODE	RESISTOR	RESISTOR
						1110..... €	2110..... € SAPPHIRE MULTI		1110..... €	2110..... € SAPPHIRE MULTI
30	102	26	25	203000	153,52				
32	112	32	32	232000	170,35				
35	112	32	32	203500	201,28				
36	112	32	32	236000	218,20				
38	118	38	32	238000	245,78				
40	118	38	32	204000	274,41				

CL 12

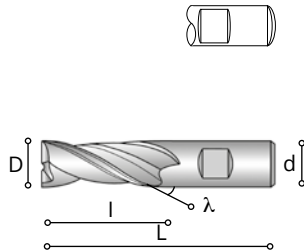

CL12



D e8	L	I	d h6	Z	CODE	HSS+8%Co 1120..... €	HSS+8%Co 2120..... € SAPPHIRE MULTI	CODE	RESISTOR 1120..... €	RESISTOR 2120..... € SAPPHIRE MULTI
3	56	8	6	2	...30000	22,80	29,74	...30030	26,71	34,05
4	63	11	6	2	...40000	22,31	29,21	...40030	26,06	33,34
5	68	13	6	2	...50000	22,31	29,21	...50030	26,06	33,34
6	68	13	6	2	...60000	21,59	28,44	...60030	25,28	32,47
7	80	16	10	2	...70000	28,18	39,40	...70030	32,93	44,63
8	88	19	10	2	...80000	26,61	37,68	...80030	31,22	42,74
9	88	19	10	2	...90000	32,21	43,85	...90030	37,88	50,08
10	95	22	10	2	...10000	29,36	40,70	...10030	34,38	46,22
11	102	22	12	2	...11000	40,88	55,96	...11030	47,89	63,66
12	110	26	12	2	...12000	36,93	51,38	...12030	43,88	59,22
13	110	26	12	2	...13000	50,12	67,25	...13030	59,08	77,10
14	110	26	12	2	...14000	47,16	63,75	...14030	55,52	72,95
15	110	26	12	2	...15000	57,70	75,60	...15030	68,19	87,11
16	123	32	16	2	...16000	57,35	74,98	...16030	67,54	86,17
17	123	32	16	2	...17000	71,42	92,45	...17030	85,01	107,39
18	123	32	16	2	...18000	70,02	90,64	...18030	88,76	111,53
19	123	32	16	2	...19000	90,26	116,20	...19030	110,99	139,34
20	141	38	20	2	...20000	89,35	123,57	...20030	98,06	122,82
22	141	38	20	2	...22000	108,80	144,97	...22030	130,86	169,22
24	166	45	25	2	...24000	152,04	210,31	...24030	188,75	250,69
25	166	45	25	2	...25000	148,89	206,84	...25030	187,76	250,25

CL 13F

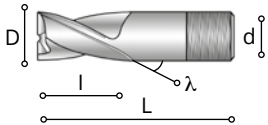
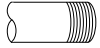

CL13F



D e8	L	l	d h8	Z	CODE	HSS+8%Co 1130..... €
4	51	7	6	204000	16,75
5	52	8	6	250000	16,40
6	52	8	6	260000	16,07
7	60	10	10	270000	21,93
8	61	11	10	280000	21,58
9	61	11	10	290000	24,69
10	63	13	10	210000	24,82
11	70	13	12	211000	29,63
12	73	16	12	212000	30,67
13	73	16	12	213000	32,60
14	73	16	12	214000	35,21
15	73	16	12	215000	39,22
16	79	19	16	216000	41,83
17	79	19	16	217000	46,36
18	79	19	16	218000	51,77
19	79	19	16	219000	64,15
20	88	22	20	220000	62,58
22	88	22	20	222000	118,70
24	102	26	25	224000	123,05
25	102	26	25	225000	123,05
26	102	26	25	226000	132,82
28	102	26	25	228000	140,66
30	102	26	25	230000	153,91
32	112	32	32	232000	170,47
35	112	32	32	235000	199,23
36	112	32	32	236000	217,01
38	118	38	32	238000	243,85
40	118	38	32	240000	271,03

CL 18

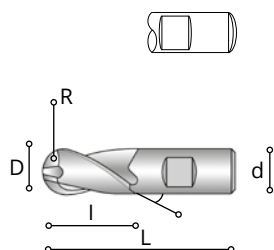

CL18



D e8	R ± 0,02	L	l	d h6	Z	CODE	HSS+8%Co 1180..... €
2	1	48	4	6	202000	33,28
3	1,5	49	5	6	230000	29,94
4	2	51	7	6	240000	28,11
5	2,5	52	8	6	250000	28,11
6	3	52	8	6	260000	28,11
7	3,5	60	10	10	270000	37,33
8	4	61	11	10	280000	37,33
9	4,5	61	11	10	290000	37,71
10	5	63	13	10	210000	38,82
11	5,5	70	13	12	211000	44,52
12	6	73	16	12	212000	44,52
13	6,5	73	16	12	213000	53,42
14	7	73	16	12	214000	53,42
15	7,5	73	16	12	215000	59,95
16	8	79	19	16	216000	59,90
17	8,5	79	19	16	217000	72,97
18	9	79	19	16	218000	72,97
19	9,5	79	19	16	219000	86,50
20	10	88	22	20	220000	86,50

CL 19

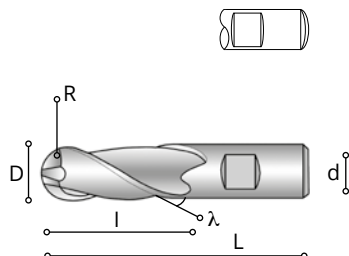

CL19



D e8	R ± 0,02	L	l	d h6	Z	CODE	HSS+8%Co 1190..... €
3	1,5	56	8	6	2	...30000	36,92
4	2	63	11	6	2	...40000	36,92
5	2,5	68	13	6	2	...50000	36,92
6	3	68	13	6	2	...60000	36,27
7	3,5	80	16	10	2	...70000	44,61
8	4	88	19	10	2	...80000	43,08
9	4,5	88	19	10	2	...90000	52,10
10	5	95	22	10	2	...10000	47,60
11	5,5	102	22	12	2	...11000	59,00
12	6	110	26	12	2	...12000	56,88
13	6,5	110	26	12	2	...13000	72,52
14	7	110	26	12	2	...14000	70,33
15	7,5	110	26	12	2	...15000	82,05
16	8	123	32	16	2	...16000	82,99
17	8,5	123	32	16	2	...17000	102,27
18	9	123	32	16	2	...18000	97,63
19	9,5	123	32	16	2	...19000	131,63
20	10	141	38	20	2	...20000	124,40

CL 16

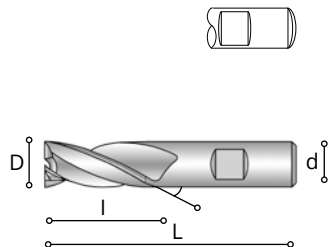

CL16



D e8	L	l	d h6	Z	CODE	HSS+8%Co 1160..... €	HSS+8%Co 2160..... € SAPHIRE MULTI	CODE	RESISTOR 1160..... €	RESISTOR 2160..... € SAPHIRE MULTI
2	51	7	6	3	...02000	22,24	29,13			
3	52	8	6	3	...30000	18,57	25,08	...30030	21,67	28,51
4	55	11	6	3	...40000	17,57	23,98	...40030	20,76	27,50
5	57	13	6	3	...50000	17,57	23,98	...50030	21,14	27,91
6	57	13	6	3	...60000	16,50	22,83	...60030	20,09	26,76
7	66	16	10	3	...70000	26,84	36,28			
8	69	19	10	3	...80000	24,83	34,07	...80030	29,15	38,83
9	69	19	10	3	...90000	29,04	38,70			
10	72	22	10	3	...10000	26,40	35,81	...10030	31,01	40,87
11	79	22	12	3	...11000	35,48	47,43			
12	83	26	12	3	...12000	32,59	44,26	...12030	39,00	51,44
13	83	26	12	3	...13000	39,86	52,95			
14	83	26	12	3	...14000	37,47	50,30	...14030	44,70	58,41
15	83	26	12	3	...15000	48,22	62,29			
16	92	32	16	3	...16000	47,01	60,82	...16030	56,42	71,16
17	92	32	16	3	...17000	60,81	77,91			
18	92	32	16	3	...18000	58,28	75,14	...18030	71,37	89,36
19	92	32	16	3	...19000	69,82	89,82			
20	104	38	20	3	...20000	70,02	93,94	...20030	87,23	112,86
22	104	38	20	3	...22000	90,76	116,75	...22030	109,45	137,31
24	121	45	25	3	...24000	130,91	167,64	...24030	161,56	201,37
25	121	45	25	3	...25000	129,29	166,21	...25030	159,67	199,64

CL 30FE

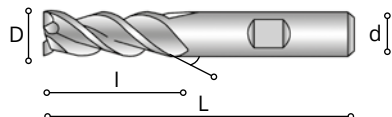

CL30FE



D js14	L	l	d h6	Z	CODE	HSS+8%Co 1300..... €
6	57	13	6	360000	23,80
8	69	19	10	380000	34,19
10	72	22	10	310000	36,63
12	83	26	12	312000	43,76
14	83	26	12	314000	46,88
16	92	32	16	316000	59,03
18	92	32	16	318000	72,22
20	104	38	20	320000	87,43

CL 17

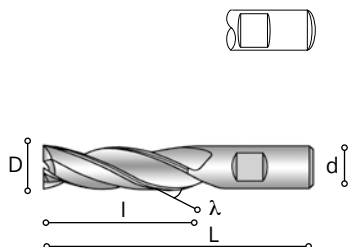

CL17



D e8	L	l	d h6	Z	CODE	HSS+8%Co 1170..... €
3	56	12	6	330000	24,50
4	63	19	6	340000	23,38
5	68	24	6	350000	22,52
6	68	24	6	360000	21,88
7	80	30	10	370000	37,18
8	88	38	10	380000	35,18
9	88	38	10	390000	36,10
10	95	45	10	310000	33,72
11	102	45	12	311000	44,67
12	110	53	12	312000	41,86
13	110	53	12	313000	52,14
14	110	53	12	314000	48,60
15	110	53	12	315000	62,17
16	123	63	16	316000	60,12
17	123	63	16	317000	78,27
18	123	63	16	318000	75,09
19	123	63	16	319000	91,85
20	141	75	20	320000	90,49
22	141	75	20	322000	116,61
24	166	90	25	324000	167,43
25	166	90	25	325000	167,43

CL 21TF

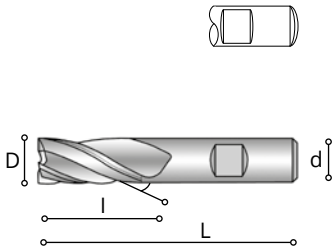

CL 21TF

INOX

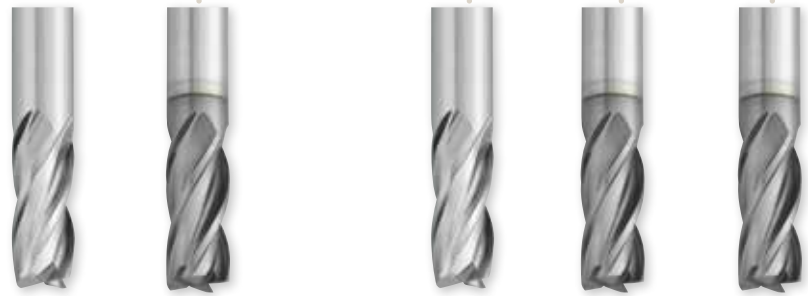

D js14	L	I	d h6	Z	CODE	HSS+8%Co 1213..... €	HSS+8%Co 2215..... € SAPPHIRE MULTI	CODE	RESISTOR 1213..... €	RESISTOR 2215..... € SAPPHIRE MULTI	RESISTOR 2218..... € PEARL
3	52	8	6	403000	17,74	24,1903030	20,36	27,06	27,06
3,5	54	10	6	403500	18,85					
4	55	11	6	404000	16,57	22,8904030	19,79	26,43	26,43
4,5	55	11	6	445000	17,92					
5	57	13	6	450000	17,01	23,3850030	19,21	25,80	25,80
5,5	57	13	6	455000	17,34					
6	57	13	6	460000	16,71	23,0560030	18,88	25,43	25,43
6,5	66	16	10	465000	26,80					
7	66	16	10	470000	26,82	36,2670030	28,05	37,62	37,62
7,5	66	16	10	475000	26,82					
8	69	19	10	480000	24,75	33,9980030	28,05	37,62	37,62
8,5	69	19	10	485000	27,27					
9	69	19	10	490000	27,27	36,1990030	29,21	38,89	38,89
9,5	69	19	10	495000	27,14					
10	72	22	10	410000	26,10	35,4810030	29,21	38,89	39,05
10,5	79	22	12	410500	32,05					
11	79	22	12	411000	32,04	43,6711030	39,75	52,13	52,13
11,5	79	22	12	411500	31,55					
12	83	26	12	412000	31,54	43,0312030	37,90	50,09	50,09
12,5	83	26	12	412500	40,77					
13	83	26	12	413000	41,38	54,7513030	45,43	59,20	59,20
13,5	83	26	12	413500	35,30					
14	83	26	12	414000	34,44	46,9914030	43,47	57,06	57,06
14,5	83	26	12	414500	43,66					
15	83	26	12	415000	44,31	57,9715030	52,99	67,57	67,57
15,5	92	32	16	415500	42,84					
16	92	32	16	416000	42,85	55,3016030	54,07	68,76	68,76
17	92	32	16	417000	65,75	86,2417030	67,68	85,46	85,46
18	92	32	16	418000	53,67	69,8918030	64,54	82,03	82,03
19	92	32	16	419000	64,45	84,1119030	78,41	99,46	99,46
20	104	38	20	420000	63,63	85,5120030	78,79	103,83	103,83
22	104	38	20	422000	99,74	126,6222030	115,52	143,98	143,98
24	121	45	25	524000	140,00	177,6424030	168,20	208,67	208,67
25	121	45	25	525000	140,00	177,6425030	168,20	208,67	208,67
26	121	45	25	526000	154,10	196,35				
28	121	45	25	628000	166,46	209,96				
30	121	45	25	630000	183,17	228,3430030	226,90	276,43	276,43
32	133	53	32	632000	212,31	263,5432030	275,24	332,54	332,54
35	133	53	32	635000	249,78					
38	143	63	32	638000	268,74					
40	143	63	32	840000	325,59					

CL 22TF

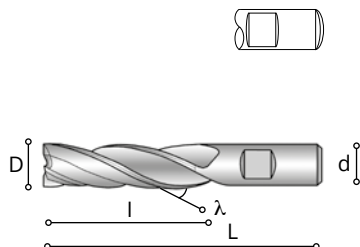

CL22TF



D js14	L	l	d h6	Z	CODE	HSS+8%Co 1223..... €	HSS+8%Co 2223..... € SAPPHIRE MULTI	CODE	RESISTOR 1223..... €	RESISTOR 2223..... € SAPPHIRE MULTI
3	56	12	6	4	...30000	25,23	33,26	...30030	26,71	34,05
4	63	19	6	4	...40000	24,22	31,32	...40030	25,98	33,25
5	68	24	6	4	...50000	23,58	30,60	...50030	25,31	32,51
6	68	24	6	4	...60000	22,58	29,52	...60030	24,37	31,47
7	80	30	10	4	...70000	35,54	47,51	...70030	39,51	51,87
8	88	38	10	4	...80000	35,33	47,28	...80030	37,88	50,08
9	88	38	10	4	...90000	35,33	47,28	...90030	39,51	51,87
10	95	45	10	4	...10000	33,42	45,17	...10030	36,26	48,29
11	102	45	12	4	...11000	43,90	59,07	...11030	49,56	65,29
12	110	53	12	4	...12000	41,56	57,34	...12030	47,02	62,40
13	110	53	12	4	...13000	50,35	67,16	...13030	56,11	73,48
14	110	53	12	4	...14000	45,10	61,49	...14030	58,10	75,79
15	110	53	12	4	...15000	59,08	76,72	...15030	66,86	85,25
16	123	63	16	4	...16000	58,73	76,48	...16030	69,96	88,84
17	123	63	16	4	...17000	84,44	106,24	...17030	91,99	114,51
18	123	63	16	4	...18000	68,67	89,16	...18030	86,37	108,63
19	123	63	16	4	...19000	99,52	126,09	...19030	112,27	140,04
20	141	75	20	4	...20000	83,56	117,19	...20030	106,95	142,95
22	141	75	20	4	...22000	121,55	158,99	...22030	147,47	187,50
24	166	90	25	5	...24000	168,70	228,64	...24030	212,03	276,30
25	166	90	25	5	...25000	168,70	228,64	...25030	220,30	285,38

CL 24TF

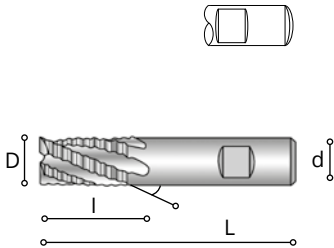

CL 24TF

INOX



D js14	L	I	d h6	Z	CODE	HSS+8%Co 1243..... €	HSS+8%Co 2245..... € SAPPHIRE MULTI	CODE	RESISTOR 1243..... €	RESISTOR 2245..... € SAPPHIRE MULTI	RESISTOR 2248..... € PEARL
6	57	13	6	3	...60000	31,56	39,38	...60030	35,68	43,91	43,91
7	66	16	10	3	...70000	47,98	59,53	...70030	57,27	69,76	69,76
8	69	19	10	3	...80000	46,74	58,18	...80030	55,88	68,24	68,24
9	69	19	10	3	...90000	47,97	59,53	...90030	57,27	69,76	69,76
10	72	22	10	4	...10000	45,33	56,64	...10030	55,47	67,78	67,78
11	79	22	12	4	...11000	52,38	66,02	...11030	63,94	78,74	78,74
12	83	26	12	4	...12000	49,81	63,20	...12030	63,03	77,74	77,74
13	83	26	12	4	...13000	57,48	72,31	...13030	70,98	87,18	87,17
14	83	26	12	4	...14000	53,34	67,78	...14030	67,65	83,51	83,51
15	83	26	12	4	...15000	63,14	78,55	...15030	80,22	97,34	97,34
16	92	32	16	4	...16000	63,94	79,43	...16030	81,70	98,97	98,97
18	92	32	16	4	...18000	71,02	88,98	...18030	90,94	110,90	110,90
20	104	38	20	4	...20000	91,22	117,25	...20030	117,18	145,82	145,81
22	104	38	20	4	...22000	102,55	129,72	...22030	132,90	163,10	163,10
24	121	45	25	4	...24000	156,09	195,34				
25	121	45	25	4	...25000	151,95	190,78	...25030	199,99	243,64	243,64
28	121	45	25	4	...28000	170,15	214,01				
30	121	45	25	5	...30000	183,48	228,67	...30030	241,77	292,79	292,79
32	133	53	32	5	...32000	213,70	264,84	...32030	284,48	342,71	342,71
35	133	53	32	5	...35000	274,56					
38	143	63	32	5	...38000	298,99					
40	143	63	32	6	...40000	298,99					

CL 24TF-PF

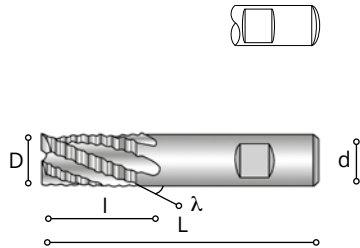

CL24TF-PF

INOX



D js14	L	l	d h6	Z	CODE	HSS+8%Co 1244..... €	HSS+8%Co 2246..... € SAPPHIRE MULTI	CODE	RESISTOR 1244..... €	RESISTOR 2246..... € SAPPHIRE MULTI	RESISTOR 2249..... € PEARL
6	57	13	6	360000	43,42	52,4360030	49,91	59,58	59,58
7	66	16	10	370000	51,07	62,7870030	70,45	83,98	83,98
8	69	19	10	380000	50,07	62,7880030	69,07	82,74	82,74
9	69	19	10	390000	51,07	62,7890030	70,45	83,98	83,98
10	72	22	10	410000	50,07	61,8510030	69,07	82,74	82,74
11	79	22	12	411000	58,01	72,2311030	80,15	96,57	96,57
12	83	26	12	412000	58,01	72,2312030	77,74	93,92	93,92
13	83	26	12	413000	65,80	81,4913030	83,56	101,00	101,00
14	83	26	12	414000	65,80	81,4914030	82,41	99,75	99,75
15	83	26	12	415000	71,08	87,2915030	90,56	108,72	108,72
16	92	32	16	416000	76,34	93,0816030	96,15	114,87	114,87
18	92	32	16	418000	94,89	115,2418030	106,14	127,62	127,62
20	104	38	20	420000	100,00	126,9220030	127,81	157,50	157,50
22	104	38	20	422000	123,78	153,3222030	153,09	185,56	185,56
24	121	45	25	424000	183,67	226,04				
25	121	45	25	425000	183,67	226,0425030	212,70	257,97	257,97
28	121	45	25	428000	193,36	239,93				
30	121	45	25	530000	212,70	261,2330030	254,41	307,10	307,10
32	133	53	32	532000	247,48	302,4532030	298,68	358,77	358,77
35	133	53	32	535000	278,42					
38	143	63	32	538000	312,97					
40	143	63	32	640000	325,98					

CL 24SL-TF

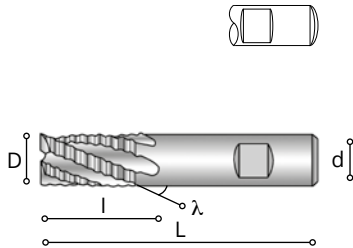

CL24SL-TF



D js14	L	l	d h6	Z	CODE	HSS+8%Co 1247..... €	HSS+8%Co 2247..... € SAPPHIRE MULTI
6	68	24	6	360000	56,35	66,66
8	88	38	10	380000	56,82	69,92
10	95	45	10	410000	58,19	71,43
12	110	53	12	412000	67,84	84,13
14	110	53	12	414000	74,45	92,37
16	123	63	16	416000	90,42	110,11
18	123	63	16	418000	101,53	123,70
20	141	75	20	420000	122,01	156,53
22	141	75	20	422000	148,68	185,86
24	166	90	25	424000	201,69	259,85
25	166	90	25	425000	201,69	259,85

CL 24SL-TF-PF

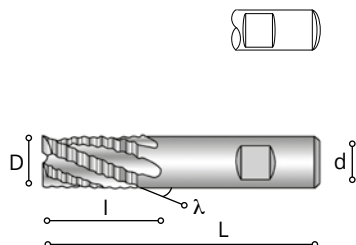
DIN
844B

CL 24SL-TF-PF

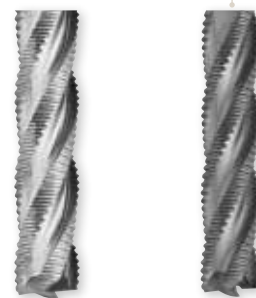

D js14	L	l	d h6	Z	CODE	HSS+8%Co 1248..... €	HSS+8%Co 2248..... € SAPPHIRE MULTI
6	68	24	6	3	...06000	66,84	78,19
8	88	38	10	3	...08000	67,39	82,53
10	95	45	10	4	...01000	69,01	84,32
12	110	53	12	4	...01200	80,45	99,27
14	110	53	12	4	...01400	83,87	104,14
16	123	63	16	4	...01600	100,36	122,28
18	123	63	16	4	...01800	114,39	139,45
20	141	75	20	4	...02000	137,47	176,50
22	141	75	20	4	...02200	161,23	202,63
24	166	90	25	4	...02400	234,25	300,74
25	166	90	25	4	...02500	234,25	300,74

CL 25TF

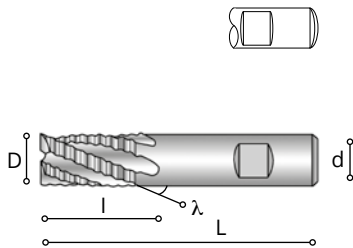

CL 25TF



D js14	L	l	d h6	Z	CODE	HSS+8%Co 1253..... €	HSS+8%Co 2253..... € SAPPHIRE MULTI
6	57	13	6	360000	32,03	39,97
7	66	16	10	370000	48,69	60,42
8	69	19	10	380000	47,44	59,05
9	69	19	10	390000	48,69	60,42
10	72	22	10	410000	46,01	57,49
11	79	22	12	411000	53,17	67,01
12	83	26	12	412000	50,56	64,15
13	83	26	12	413000	58,34	73,39
14	83	26	12	414000	54,14	68,80
15	83	26	12	415000	64,09	79,73
16	92	32	16	416000	64,90	80,62
18	92	32	16	418000	72,09	90,31
20	104	38	20	420000	92,59	119,01
22	104	38	20	422000	104,09	131,67
24	121	45	25	424000	158,43	198,27
25	121	45	25	425000	154,23	193,64

CM 31

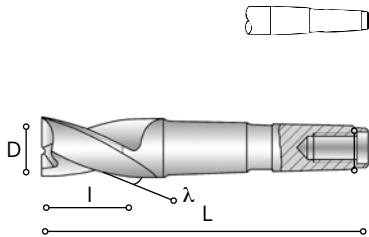

CM31



D e8	L	I	CM	Z	CODE	HSS+8%Co 1310..... €
14	101	16	2	214000	61,68
15	101	16	2	215000	68,84
16	104	19	2	216000	64,58
17	104	19	2	217000	71,52
18	104	19	2	218000	67,54
19	104	19	2	219000	82,77
20	124	22	3	220000	100,36
21	124	22	3	221000	109,31
22	124	22	3	222000	105,49
23	124	22	3	223000	122,90
24	128	26	3	224000	116,47
25	128	26	3	225000	120,00
26	128	26	3	226000	129,49
28	128	26	3	228000	145,34
30	128	26	3	230000	164,11
32	157	32	4	232000	204,10
34	157	32	4	234000	223,37
35	157	32	4	235000	240,85
36	157	32	4	236000	255,07
38	163	38	4	238000	287,02
40	163	38	4	240000	317,73

CM 36



CM 37FE

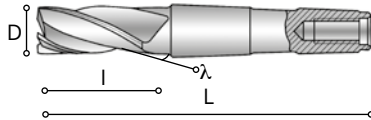

CM36



CM37FE



CM36 D e8 CM37FE D js14	L	I	CM	Z	CODE	HSS+8%Co 1360..... €	HSS+8%Co 1370..... €
14	111	26	2	314000	69,81	
15	111	26	2	315000	73,98	
16	117	32	2	316000	75,05	86,67
17	117	32	2	317000	99,98	
18	117	32	2	318000	81,50	
19	117	32	2	319000	110,87	
20	140	38	3	320000	116,93	142,95
21	140	38	3	321000	129,34	
22	140	38	3	322000	123,70	
23	140	38	3	323000	139,97	
24	147	45	3	324000	140,46	
25	147	45	3	325000	143,51	173,73
26	147	45	3	326000	151,09	
28	147	45	3	328000	160,28	
30	147	45	3	330000	186,56	203,94
32	178	53	4	332000	222,27	
34	178	53	4	334000	240,44	
35	178	53	4	335000	257,63	263,79
36	178	53	4	336000	262,29	
38	188	63	4	338000	309,72	
40	188	63	4	340000	348,14	406,94

CM 38

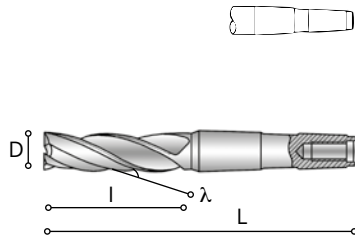

CM38



D js14	L	I	CM	Z	CODE	HSS+8%Co 1380..... €
16	148	63	2	316000	93,28
18	148	63	2	318000	101,57
20	177	75	3	320000	134,76
22	177	75	3	322000	151,47
24	192	90	3	324000	187,86
25	192	90	3	325000	197,18
26	192	90	3	326000	203,69
28	192	90	3	328000	216,16
30	192	90	3	330000	237,10
32	231	106	4	332000	319,29
34	231	106	4	334000	358,52
35	231	106	4	335000	376,66
36	231	106	4	336000	410,90
38	250	125	4	338000	474,96
40	250	125	4	340000	533,10

CM 41TF

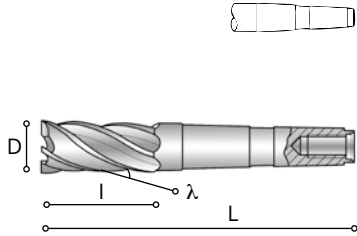

CM41TF



D js14	L	I	CM	Z	CODE	HSS+8%Co 1410..... €	HSS+8%Co 2410..... € SAPPHIRE MULTI	CODE	RESISTOR 1410..... €	RESISTOR 2410..... € SAPPHIRE MULTI
14	111	26	2	414000	69,40	90,37			
15	111	26	2	415000	76,51	97,98			
16	117	32	2	416000	71,53	92,5016030	82,90	104,81
17	117	32	2	417000	76,10				
18	117	32	2	418000	73,92	94,9318030	89,55	112,54
19	117	32	2	419000	87,35				
20	140	38	3	420000	104,91	139,5120030	131,32	168,46
21	140	38	3	421000	116,81				
22	140	38	3	422000	117,28	153,1322030	150,50	189,19
23	140	38	3	523000	140,82				
24	147	45	3	524000	135,86	192,5024030	170,62	230,75
25	147	45	3	525000	139,05	196,0225030	174,66	235,18
26	147	45	3	526000	145,00	214,2926030	183,30	256,43
28	147	45	3	628000	155,46	227,4528030	191,64	265,61
30	147	45	3	630000	177,56	250,1230030	232,36	312,03
32	178	53	4	632000	205,52	287,0032030	275,24	363,69
34	178	53	4	634000	234,28	318,6434030	306,36	397,93
35	178	53	4	635000	237,15	323,0135030	305,83	397,35
36	178	53	4	636000	275,90	373,5336030	331,22	434,38
38	188	63	4	638000	283,70	392,7138030	366,09	483,35
40	188	63	4	840000	318,79	431,3340030	425,62	550,43
42	188	63	4	842000	497,17				
44	188	63	4	844000	498,05				
45	188	63	4	845000	442,96	45030	594,34	
50	233	75	5	850000	604,32	50030	837,60	

CM 41R



CM 44R

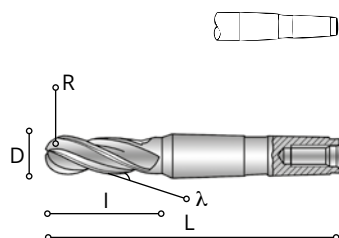

CM41R

CM44R



D js14	R ±0,02	L	I	CM	CM41R Z	CM44R Z	CODE	HSS+8%Co 1411..... €	HSS+8%Co 1441..... €
16	8	117	32	2	4	316000	118,57	122,91
20	10	140	38	3	4	420000	142,00	167,01
25	12,5	147	45	3	5	425000	198,92	228,62
30	15	147	45	3	6	530000	255,76	297,35
32	16	178	53	4	6	532000	321,98	330,67
40	20	188	63	4	8	640000	374,65	467,18

FRESE CILINDRICHE FRONTALI | MULTIFLUTE FINISHING CUTTERS

CM 42

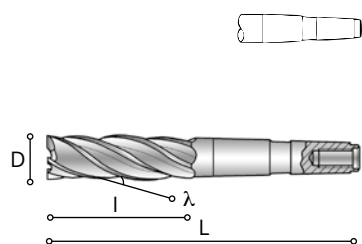

CM42



D js14	L	I	CM	Z	CODE	HSS+8%Co 1420..... €	HSS+8%Co 2420..... € SAPPHIRE MULTI	CODE	RESISTOR 1420..... €	RESISTOR 2420..... € SAPPHIRE MULTI
16	148	63	2	416000	92,25	119,8116030	110,86	140,29
18	148	63	2	418000	96,50	124,5018030	116,23	146,20
20	177	75	3	420000	128,91	186,1720030	153,84	212,30
22	177	75	3	422000	148,73	206,6722030	182,63	243,97
24	192	90	3	524000	185,99	257,1024030	237,22	313,46
25	192	90	3	525000	186,41	257,5925030	235,17	312,79
26	192	90	3	526000	197,31	280,2526030	243,55	331,11
28	192	90	3	628000	213,95	298,5528030	266,12	355,95
30	192	90	3	630000	231,15	317,4730030	286,74	378,61
32	231	106	4	632000	319,23	434,8932030	403,13	527,18
34	231	106	4	634000	351,29	470,1634030	450,12	578,88
35	231	106	4	635000	369,14	489,7935030	476,17	607,52
36	231	106	4	636000	387,97	523,4236030	504,71	651,85
38	250	125	4	638000	465,27	608,4538030	614,01	772,08
40	250	125	4	840000	515,89	664,1540030	690,55	856,27
45	250	125	4	845000	621,87	45030	853,24	
50	308	150	5	850000	892,03	50030	1249,05	

CM 42R



CM 48R

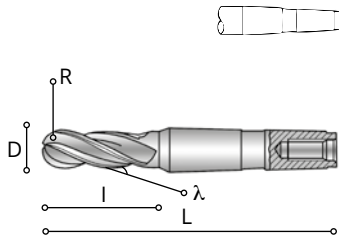

CM42R

CM48R



D js14	R ± 0,02	L	I	CM	CM42R Z	CM48R Z	CODE	HSS+8%Co 1421..... €	HSS+8%Co 1481..... €
16	8	148	63	2	4	316000	137,89	154,79
20	10	177	75	3	4	420000	192,18	214,87
25	12,5	192	90	3	5	425000	255,83	303,88
30	15	192	90	3	6	530000	334,60	384,02
32	16	231	106	4	6	532000	405,39	467,81
40	20	250	125	4	8	640000	565,21	668,99

CM 43

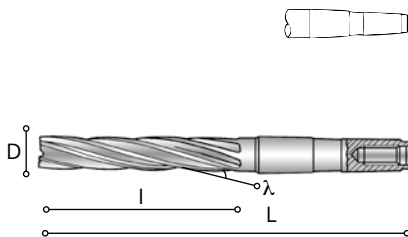

CM43



D js14	L	I	CM	Z	CODE	HSS+8%Co 1430..... €
16	170	90	2	616000	134,45
18	200	100	3	818000	201,63
20	210	110	3	820000	215,65
22	210	110	3	822000	229,59
24	225	125	3	824000	268,47
25	225	125	3	825000	292,18
26	250	125	4	826000	324,83
28	265	140	4	828000	355,45
30	265	140	4	830000	386,49
32	285	160	4	1032000	434,16
34	285	160	4	1034000	464,65
36	305	180	4	1036000	504,13
38	310	185	4	1038000	577,72
40	315	190	4	1040000	646,94

CM 44TF



CM 44TF



CM 44

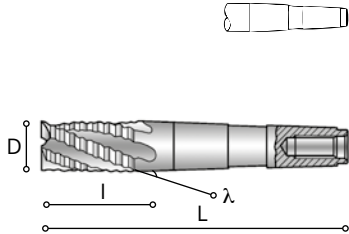

CM44TF



D js14	L	I	CM	Z	CODE	HSS+8%Co 1444..... €	HSS+8%Co 2444..... € SAPHIRE MULTI	CODE	RESISTOR 1444..... €	RESISTOR 2444..... € SAPHIRE MULTI
16	117	32	2	3	...16000	86,24	108,49	...16030	106,06	130,28
18	117	32	2	3	...18000	94,74	117,82	...18030	119,67	145,58
20	140	38	3	4	...20000	128,16	165,09	...20030	158,37	197,86
22	140	38	3	4	...22000	135,21	172,38	...22030	170,34	211,00
24	147	45	3	4	...24000	154,02	212,49	...24030	194,08	256,55
25	147	45	3	4	...25000	158,64	217,57	...25030	201,78	265,51
26	147	45	3	4	...26000	165,50	236,83	...26030	215,90	292,28
28	147	45	3	4	...28000	186,09	260,32	...28030	233,27	311,39
30	147	45	3	5	...30000	201,67	276,63	...30030	261,18	341,89
32	178	53	4	5	...32000	241,32	326,38	...32030	300,78	391,79
35	178	53	4	5	...35000	264,00	351,33			
36	178	53	4	5	...36000	277,38	376,54			
40	188	63	4	6	...40000	328,85	444,01	...40030	431,80	549,92
45	188	63	4	6	...45000	458,11				
50	233	75	5	6	...50000	622,45				

CM 48

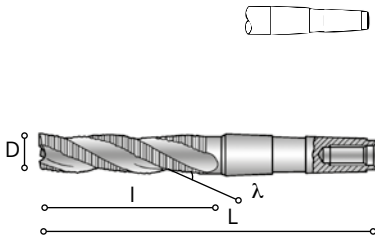

CM48



D js14	L	I	CM	Z	CODE	HSS+8%Co	HSS+8%Co	CODE	RESISTOR	RESISTOR
						1480..... €	2480..... € SAPHIRE MULTI		1480..... €	2480..... € SAPHIRE MULTI
16	148	63	2	316000	112,30	141,8716030	140,91	173,35
18	148	63	2	318000	117,62	147,7218030	147,85	180,97
20	177	75	3	420000	168,75	229,5520030	215,58	280,20
22	177	75	3	422000	178,77	239,7122030	232,53	298,85
24	192	90	3	424000	228,95	304,3824030	297,47	379,74
25	192	90	3	425000	233,75	309,6525030	305,99	389,10
28	192	90	3	428000	263,51	353,0728030	346,95	444,85
30	192	90	3	530000	280,15	371,3730030	367,86	467,85
32	231	106	4	532000	351,54	470,4332030	468,27	598,83
35	231	106	4	535000	392,47	515,4635030	523,67	659,76
38	250	125	4	538000	500,47	647,1738030	680,19	844,87
40	250	125	4	640000	515,66	663,8940030	717,18	885,57
45	250	125	4	645000	648,85	45030	875,06	
50	308	150	5	650000	899,50	50030	1314,23	

CM45TF

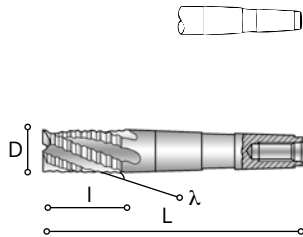

CM45TF



D js14	L	I	CM	Z	CODE	HSS+8%Co 1450..... €
16	117	32	2	316000	87,53
18	117	32	2	318000	96,16
20	140	38	3	420000	122,75
22	140	38	3	422000	137,24
24	147	45	3	424000	156,33
25	147	45	3	425000	161,02
26	147	45	3	426000	167,97
28	147	45	3	428000	186,09
30	147	45	3	530000	204,70
32	178	53	4	532000	244,94
35	178	53	4	535000	257,90
36	178	53	4	536000	265,67
40	188	63	4	640000	327,24
45	188	63	4	645000	447,54
50	233	75	5	650000	631,79

CS 47

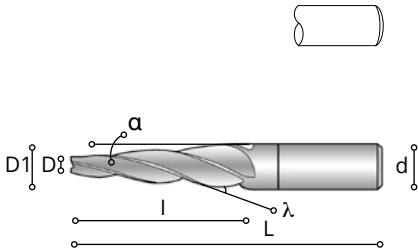

CS47



$\alpha \pm 10'$	D k12	D1	L	l	d h8	Z	CODE	HSS+8%Co 1470..... €
0° 30'	3	3,3	60	17	6	3	...03003	31,21
0° 30'	4	4,4	65	23	6	3	...03004	31,21
0° 30'	5	5,5	70	29	6	3	...03005	39,18
0° 30'	6	6,5	75	29	10	4	...03006	47,22
1°	3	3,5	60	15	6	3	...10003	34,53
1°	4	4,7	65	20	6	3	...10004	34,53
1°	5	5,9	70	26	6	3	...10005	42,13
1°	6	7,4	80	40	8	4	...10006	50,68
1°	8	9,6	90	45	10	4	...10008	56,01
1°30'	3	3,8	60	16	6	3	...13003	44,18
1°30'	4	5	65	19	6	3	...13004	46,41
1°30'	5	6,3	70	25	6	3	...13005	49,43
1°30'	6	8,1	80	40	8	4	...13006	53,70
1°30'	8	10,35	90	45	10	4	...13008	60,44
2°	3	4,1	60	16	6	3	...20003	32,84
2°	4	6	65	28,5	6	3	...20004	42,13
2°	5	6,75	70	25	6	3	...20005	48,61
2°	6	8,8	80	40	8	4	...20006	56,20
2°	8	11,15	90	45	12	4	...20008	91,94
3°	6	12,3	100	60	12	4	...30006	74,04
3°	8	16,4	125	80	16	4	...30008	108,50
4°	6	13	100	50	12	4	...40006	91,58
4°	8	18,5	125	75	20	4	...40008	133,16
5°	6	16,5	112	60	16	4	...50006	120,77
6°	8	17,45	100	45	16	4	...60008	186,63
7°	6	19,75	112	56	20	4	...70006	217,77
2°52'	6	10	95	40	10	4	...25206	75,39
2°52'	12	20	140	80	20	4	...25212	97,14
4° 34'	6	16	112	62,5	16	4	...43406	217,77
5° 43'	6	14	95	40	12	4	...54306	88,85
7° 7'	6	20	120	56	20	4	...77006	131,73

TCL 60A



TCL 60B

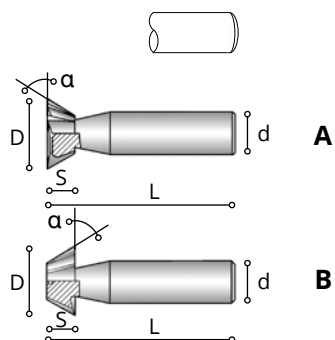

D js16	α ± 30'	L	S js14	d h8	Z	CODE	HSS+5%Co
							1601..... A
							1602..... B
							€
16	45°	60	4	12	816450	63,06
20	45°	63	5	12	820450	82,34
25	45°	67	6,3	16	1025450	102,22
32	45°	71	8	16	1232450	147,63
16	60°	60	6,3	12	816600	63,06
20	60°	63	8	12	820600	82,34
25	60°	67	10	16	1025600	102,22
32	60°	71	12,5	16	1232600	147,63
16	70°	60	7	12	816700	63,06
20	70°	63	9	12	820700	82,34
25	70°	67	11	16	1025700	102,22

TCL 61

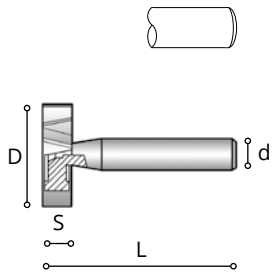

TCL61



D +0,05 -0	s d9	L	d h8	Z	CODE	HSS+5%Co 1610..... €
10,5	2	50	6	610520	50,24
10,5	2,5	50	6	610525	50,24
10,5	3	50	6	610530	50,24
13,5	2	56	10	813520	55,64
13,5	3	56	10	813530	55,64
13,5	4	56	10	813540	55,64
16,5	3	56	10	816530	65,51
16,5	4	56	10	816540	65,51
16,5	5	56	10	816550	65,51
16,5	6	56	10	816560	65,51
19,5	3	56	10	819530	74,49
19,5	4	56	10	819540	74,49
19,5	5	56	10	819550	74,49
19,5	6	56	10	819560	74,49
22,5	4	56	10	822540	87,06
22,5	5	56	10	822550	87,06
22,5	6	56	10	822560	87,06
22,5	8	56	10	822580	87,06
25,5	5	56	10	825550	100,48
25,5	6	56	10	825560	100,48
25,5	7	56	10	825570	100,48
25,5	8	56	10	825580	100,47
28,5	6	56	10	828560	119,34
28,5	8	56	10	828580	119,34
28,5	10	63	12	828510	119,34
32,5	6	56	10	1032560	139,07
32,5	7	56	10	1032570	139,07
32,5	8	56	10	1032580	139,07
32,5	10	63	12	1032510	139,07
45,5	10	63	12	1045510	195,65

TCL 62



12°-15°

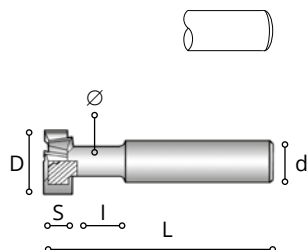

TCL62



$D \begin{smallmatrix} +0,05 \\ 0 \end{smallmatrix}$	$S \begin{smallmatrix} +0 \\ -0,05 \end{smallmatrix}$	\emptyset	L	I	d h8	Z	CODE	HSS+5%Co 1620..... €
12,5	6	5	57	11	10	612500	74,49
16	8	7	62	14	10	616000	87,06
18	8	8	70	17	12	618000	96,01
19	9	8	70	17	12	619000	99,63
21	9	10	74	20	12	621000	110,35
22	10	10	74	20	12	622000	113,97
25	11	12	82	23	16	625000	133,89
28	12	13	85	25	16	628000	149,87
32	14	15	90	28	16	832000	176,69

TCM 63



12°-15°

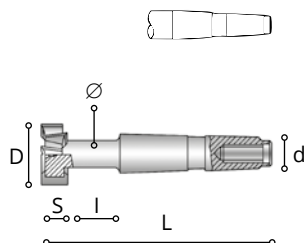

TCM63



$D \begin{smallmatrix} +0,05 \\ 0 \end{smallmatrix}$	$S \begin{smallmatrix} +0 \\ -0,05 \end{smallmatrix}$	Ø	L	I	CM	Z	CODE	HSS+5%Co 1630..... €
22	10	10	98	20	2	622000	131,96
25	11	12	103	23	2	625000	143,66
28	12	13	106	25	2	628000	162,49
32	14	15	111	28	2	832000	192,29
36	16	17	133	32	3	836000	217,43
40	18	19	138	35	3	840000	260,73
45	20	21	143	38	3	845000	311,80
50	22	25	173	43	4	1050000	389,90
56	24	28	182	50	4	1056000	502,45

RC 135

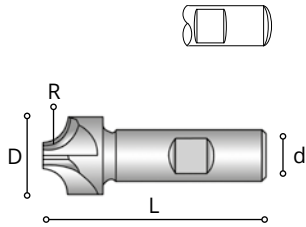

RC135



R H11	D js14	L	d h6	Z	CODE	HSS+5%Co 1135..... €
1	8	60	10	401000	44,89
1,5	9	60	10	415000	44,89
2	10	60	10	420000	44,89
2,5	11	60	10	425000	45,09
3	12	60	12	430000	68,12
3,5	14	60	12	435000	71,41
4	14	60	12	440000	71,41
4,5	16	60	12	445000	77,68
5	16	60	16	450000	77,68
5,5	20	67	16	455000	91,98
6	20	67	16	460000	91,98
6,5	24	71	16	465000	103,59
7	24	71	16	470000	103,59
7,5	24	71	16	475000	103,59
8	24	71	16	480000	103,59
8,5	28	85	20	485000	114,46
9	28	85	20	490000	114,46
9,5	28	85	20	495000	114,46
10	28	85	20	410000	114,46
10,5	32	90	20	410500	142,77
11	32	90	20	411000	142,77
12	34	90	20	412000	143,24
13	42	100	20	413000	243,26
14	44	100	20	614000	244,56
15	46	100	20	601500	304,91
16	48	100	20	616000	304,91
18	52	112	20	618000	447,12
20	58	112	20	602000	601,29

CR 81

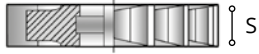

CR81



D js16	S k11	d H7	Z	CODE	HSS+5%Co 181..... €
50	4	16	20	...150004	98,75
50	5	16	20	...150005	98,75
50	6	16	20	...150006	105,56
50	8	16	20	...150008	110,10
50	10	16	20	...150010	129,64
63	4	22	22	...263004	113,18
63	5	22	22	...263005	119,35
63	6	22	22	...263006	119,35
63	8	22	22	...263008	131,94
63	10	22	22	...263010	145,66
63	12	22	20	...263012	153,07
63	14	22	20	...263014	166,78
80	6	22	24	...280006	159,75
80	8	22	24	...280008	166,29
80	10	22	24	...280010	179,00
80	12	22	24	...280012	192,73
80	14	22	20	...280014	207,25
80	16	22	20	...280016	231,47
80	18	22	20	...280018	239,57
80	6	27	24	...380006	159,75
80	8	27	24	...380008	166,29
80	10	27	24	...380010	179,00
80	12	27	24	...380012	192,73
80	14	27	20	...380014	207,25
80	16	27	20	...380016	219,02
80	18	27	20	...380018	239,57
100	6	27	26	...310006	206,24
100	8	27	26	...310008	224,84
100	10	27	26	...310010	243,25
100	12	27	26	...310012	263,94
100	14	27	22	...310014	283,59
100	16	27	22	...310016	299,76
100	18	27	22	...310018	320,48
100	20	27	22	...310020	352,18
100	18	32	22	...410018	320,47
100	20	32	22	...410020	338,97
125	8	32	30	...412508	305,17
125	10	32	30	...412510	325,80
125	12	32	24	...412512	349,95
125	14	32	24	...412514	378,18

CR 81



H

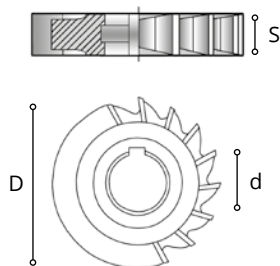

CR81



D js16	S k11	d H7	Z	CODE	HSS+5%Co 181..... €
125	16	32	24	...412516	412,76
125	18	32	24	...412518	461,14
125	20	32	24	...412520	495,79
160	10	32	36	...416010	486,56
160	12	32	30	...416012	521,38
160	14	32	30	...416014	561,81
160	16	32	30	...416016	599,58
160	18	32	30	...416018	641,74
160	20	32	30	...416020	681,98
160	22	32	30	...416022	765,58
160	25	32	30	...416025	899,31
160	28	32	30	...416028	1025,19
160	32	32	30	...416032	1184,63
160	18	40	30	...516018	641,74
160	20	40	30	...516020	681,98
160	22	40	30	...516022	765,58
160	25	40	30	...516025	899,31
160	28	40	30	...516028	1025,19
160	32	40	30	...516032	1184,63

CR 83

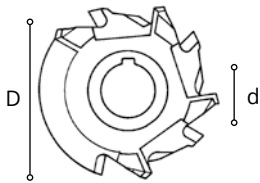
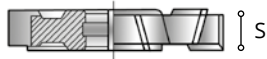

CR83



D js16	S k11	d H7	Z	CODE	HSS+5%Co 183..... €
50	3	16	14	...150003	111,37
50	4	16	14	...150004	97,79
50	5	16	14	...150005	97,79
50	6	16	14	...150006	104,53
50	7	16	14	...150007	109,03
50	8	16	14	...150008	109,03
50	9	16	14	...150009	122,48
50	10	16	14	...150010	126,24
63	3	22	16	...263003	140,83
63	4	22	16	...263004	112,09
63	5	22	16	...263005	118,21
63	6	22	16	...263006	118,21
63	7	22	14	...263007	124,33
63	8	22	14	...263008	130,66
63	9	22	14	...263009	137,48
63	10	22	14	...263010	144,24
63	12	22	14	...263012	151,57
63	14	22	14	...263014	166,78
63	16	22	14	...263016	177,29
63	18	22	14	...263018	184,49
80	3	22	18	...280003	170,44
80	4	22	18	...280004	140,83
80	5	22	18	...280005	150,00
80	6	22	18	...280006	158,19
80	7	22	16	...280007	163,61
80	8	22	16	...280008	163,61
80	9	22	16	...280009	170,44
80	10	22	16	...280010	184,16
80	12	22	16	...280012	198,29
80	14	22	16	...280014	213,24
80	16	22	16	...280016	227,56
80	18	22	16	...280018	239,57
80	20	22	16	...280020	253,97
80	3	27	18	...380003	170,44
80	4	27	18	...380004	140,83
80	5	27	18	...380005	150,00
80	6	27	18	...380006	158,19
80	7	27	16	...380007	163,61
80	8	27	16	...380008	163,61
80	9	27	16	...380009	170,44

CR 83

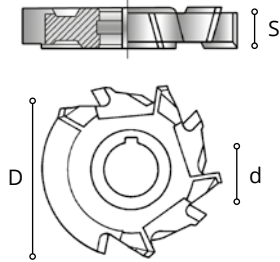

CR83



D js16	S k11	d H7	Z	CODE	HSS+5%Co 183..... €
80	10	27	16	...380010	184,16
80	12	27	16	...380012	198,29
80	14	27	16	...380014	213,24
80	16	27	16	...380016	227,56
80	18	27	16	...380018	239,57
80	20	27	16	...380020	253,97
100	3	27	22	...310003	234,05
100	4	27	22	...310004	189,77
100	5	27	22	...310005	195,41
100	6	27	22	...310006	204,24
100	7	27	18	...310007	213,64
100	8	27	18	...310008	222,65
100	9	27	18	...310009	231,78
100	10	27	18	...310010	240,89
100	12	27	18	...310012	261,38
100	14	27	18	...310014	283,59
100	16	27	18	...310016	299,76
100	18	27	18	...310018	320,48
100	20	27	18	...310020	338,97
100	3	32	22	...410003	234,05
100	4	32	22	...410004	189,77
100	5	32	22	...410005	195,41
100	6	32	22	...410006	204,24
100	7	32	18	...410007	213,64
100	8	32	18	...410008	222,65
100	9	32	18	...410009	231,78
100	10	32	18	...410010	240,89
100	12	32	18	...410012	261,38
100	14	32	18	...410014	283,59
100	16	32	18	...410016	299,76
100	18	32	18	...410018	320,48
100	20	32	18	...410020	338,97
125	4	32	24	...412504	288,64
125	5	32	24	...412505	283,22
125	6	32	24	...412506	283,22
125	7	32	20	...412507	295,41
125	8	32	20	...412508	302,21
125	10	32	20	...412510	322,65
125	12	32	20	...412512	346,55
125	14	32	20	...412514	378,18

CR 83

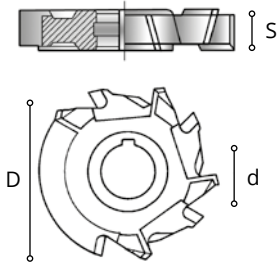

CR83



D js16	S k11	d H7	Z	CODE	HSS+5%Co 183..... €
125	16	32	20	...412516	412,76
125	18	32	20	...412518	461,14
125	20	32	20	...412520	495,79
125	22	32	20	...412522	561,01
125	25	32	18	...412525	656,98
160	5	32	26	...416005	468,11
160	6	32	26	...416006	422,49
160	7	32	26	...416007	476,12
160	8	32	26	...416008	445,23
160	10	32	22	...416010	481,84
160	12	32	22	...416012	516,31
160	14	32	22	...416014	561,81
160	16	32	24	...416016	599,58
160	18	32	24	...416018	641,74
160	20	32	22	...416020	681,98
160	22	32	22	...416022	765,58
160	25	32	22	...416025	899,25
160	32	32	22	...416032	1184,63
160	5	40	26	...516005	468,11
160	6	40	26	...516006	422,49
160	7	40	26	...516007	476,12
160	8	40	26	...516008	445,23
160	10	40	22	...516010	481,84
160	12	40	22	...516012	516,31
160	14	40	22	...516014	561,81
160	16	40	24	...516016	599,58
160	18	40	24	...516018	641,74
160	20	40	22	...516020	681,98
160	32	40	22	...516032	1184,63
200	10	40	34	...520010	729,18
200	12	40	30	...520012	777,70
200	14	40	30	...520014	840,64
200	16	40	30	...520016	909,75
200	18	40	30	...520018	986,22
200	20	40	28	...520020	1069,78
200	28	40	28	...520028	1389,24
250	14	40	36	...525014	1298,91
250	16	40	36	...525016	1438,22
250	18	40	36	...525018	1541,99
250	20	40	36	...525020	1611,01

CR 85



8°-15°

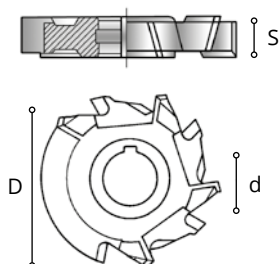

CR85



D js16	S k11	d H7	Z	CODE	HSS+5%Co 185..... €
63	1,6	22	28	...263016	144,41
63	2	22	28	...263002	130,83
63	2,5	22	28	...263025	130,83
80	1,6	27	32	...380016	162,51
80	2	27	32	...380002	162,51
80	2,5	27	32	...380025	162,51
100	1,6	32	36	...410016	194,65
100	2	32	36	...410002	194,65
100	2,5	32	36	...410025	194,65
125	1,6	32	40	...412516	261,67
125	2	32	40	...412502	261,67
125	2,5	32	40	...412525	261,67
125	3	32	40	...412503	261,67
160	2	40	44	...516002	376,49
160	2,5	40	44	...516025	376,49
160	3	40	44	...516003	376,49
160	4	40	44	...516004	376,49

FA 91

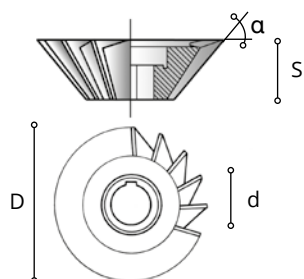

FA91



D js16	α ± 25'	S js14	d H7	Z	CODE	HSS+5%Co 1910..... €
40	45°	10	10	1440045	129,85
50	45°	13	13	1650045	153,98
63	45°	18	16	1663045	205,55
80	45°	22	22	1880045	324,58
100	45°	28	27	2010045	552,67
40	50°	13	10	1440050	129,85
50	50°	16	13	1650050	153,98
63	50°	20	16	1663050	205,55
80	50°	25	22	1880050	324,58
100	50°	32	27	2010050	552,67
40	60°	13	10	1440060	129,85
50	60°	16	13	1650060	153,98
63	60°	20	16	1663060	205,55
80	60°	25	22	1880060	324,58
100	60°	32	27	2010060	552,67

FP 92



H

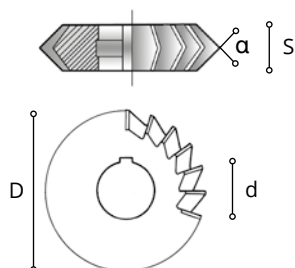

FP92



D js16	$\alpha \pm 30'$	S js16	d H7	Z	CODE	HSS+5%Co 1920..... €
50	45°	8	16	1650045	129,76
63	45°	10	22	1863045	175,87
80	45°	12	27	1880045	263,22
100	45°	18	32	2010045	377,82
50	60°	10	16	1650060	139,59
63	60°	14	22	1863060	186,12
80	60°	18	27	1880060	270,25
100	60°	25	32	2010060	411,09
50	90°	14	16	1650090	145,46
63	90°	20	22	1863090	200,74
80	90°	22	27	1880090	297,14
100	90°	32	32	2010090	441,78

CF 94

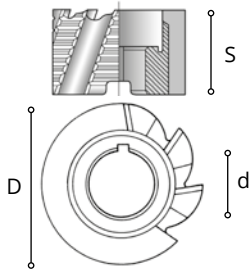

CF94



D js16	S k16	d H7	Z	CODE	HSS+8%Co	HSS+8%Co	CODE	RESISTOR	RESISTOR
					1940..... €	2940..... € SAPPHIRE MULTI		1940..... €	2940..... € SAPPHIRE MULTI
40	32	16	640000	174,24	241,3440030	233,64	307,69
50	36	22	650000	230,05	304,6150030	315,46	398,55
63	40	27	863000	326,21	433,7663030	447,10	566,74
80	45	27	1080000	510,76	654,1880030	716,60	880,58
100	50	32	1210000	769,02	970,2710030	1068,27	1299,44
160	63	50	1616000	2278,18				

CF 95

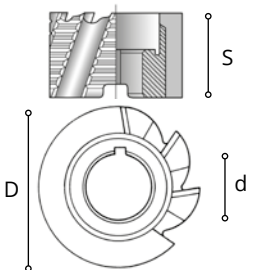

CF95



D js16	S k16	d H7	Z	CODE	HSS+8%Co
					1950..... €
40	32	16	640000	174,23
50	36	22	650000	230,06
63	40	27	863000	326,21
80	45	27	1080000	510,76
100	50	32	1210000	769,02

CF 96

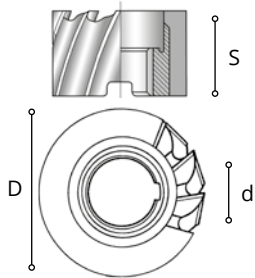

CF96



D js16	S k16	d H7	Z	CODE	HSS+8%Co 1960..... €	HSS+8%Co 2960..... € SAPPHIRE MULTI	CODE	RESISTOR 1960..... €	RESISTOR 2960..... € SAPPHIRE MULTI
40	32	16	8	...40000	131,00	193,91	...40030	182,38	251,79
50	36	22	8	...50000	173,89	243,87	...50030	239,51	315,78
63	40	27	10	...63000	251,21	353,52	...63030	327,66	435,35
80	45	27	10	...80000	366,09	495,03	...80030	504,56	647,35
100	50	32	12	...10000	589,46	772,76	...10030	805,95	1010,89

CF 97
ALU

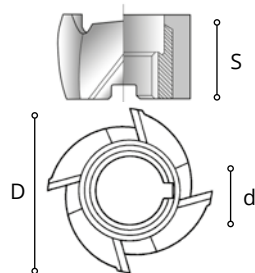

CF97



D js16	S k16	d H7	Z	CODE	HSS+5%Co 1970..... €
40	32	16	3	...40000	128,11
50	36	22	3	...50000	166,53
63	40	27	4	...63000	236,85
80	45	27	4	...80000	352,04
100	50	32	4	...10000	569,14
125	56	40	5	...12500	1047,86

CF 98



CF 99

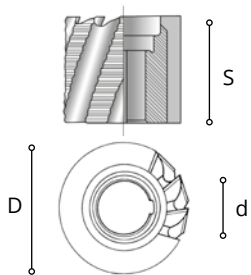

CF98

CF99



D js16	S k16	d H7	CF98 Z	CF99 Z	CODE	HSS+8%Co 1980..... €	HSS+8%Co 1990..... €
30	30	13	6	5	...30000	115,05	141,63
35	35	16	8	5	...35000	128,72	160,05
40	40	16	8	6	...40000	164,73	196,90
50	50	22	8	6	...50000	241,07	255,67
60	60	27	10	8	...60000	328,86	399,89
75	75	27	10	10	...75000	563,61	677,22

SCR 121

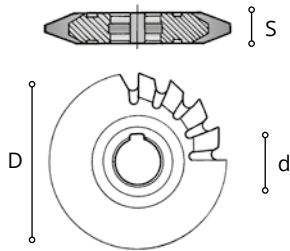

N

 λ
0°

SCR121



Mod	D js16	S js16	d H7	Z	CODE	HSS+5%Co 1121..... €
1	100	8	22	1801000	339,48
1,5	100	8	22	1815000	339,47
2	100	8	22	1620000	349,02
2,5	100	9	22	1625000	355,41
3	100	10	22	1630000	368,06
3,5	100	11	22	1635000	390,27
4	100	11	22	1640000	390,27
4,5	125	13	27	1845000	755,15
5	125	14	27	1850000	755,15
5,5	125	15	27	1855000	863,00
6	125	16	27	1860000	863,00
6,5	125	17	27	1865000	920,21
7	125	18	27	1870000	920,21
8	125	21	27	1880000	999,54
9	125	24	27	1890000	999,54
10	125	26	27	1810000	1110,62

SCV 131

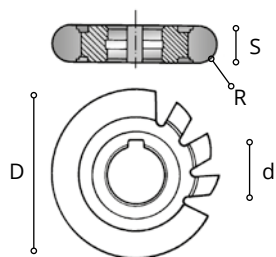

SCV131



R h11	D js16	S	d H7	Z	CODE	HSS+5%Co 1131..... €
1	50	2	16	1401000	114,83
1,5	50	3	16	1401500	120,30
2	50	4	16	1402000	122,96
2,5	63	5	22	1225000	130,71
3	63	6	22	1230000	138,25
3,5	63	7	22	1235000	158,66
4	63	8	22	1240000	165,78
4,5	63	9	22	1245000	173,54
5	63	10	22	1250000	181,31
5,5	80	11	27	1255000	212,56
6	80	12	27	1260000	212,56
6,5	80	13	27	1265000	229,45
7	80	14	27	1270000	238,64
7,5	80	15	27	1275000	248,35
8	80	16	27	1280000	258,84
8,5	100	17	32	1285000	304,54
9	100	18	32	1290000	316,62
9,5	100	19	32	1295000	328,68
10	100	20	32	1210000	344,48

SCC 132

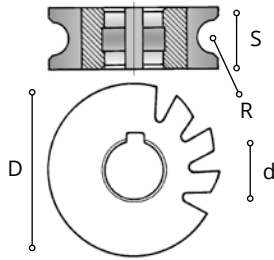

SCC132



R H11	D js16	S	d H7	Z	CODE	HSS+5%Co 1132..... €
1	50	6	16	1401000	146,82
1,5	50	8	16	1401500	153,19
2	50	9	16	1402000	152,20
2,5	63	10	22	1225000	156,44
3	63	12	22	1230000	179,36
3,5	63	14	22	1235000	196,68
4	63	16	22	1240000	215,79
4,5	63	18	22	1245000	232,32
5	63	20	22	1250000	244,32
5,5	80	22	27	1255000	275,43
6	80	24	27	1260000	304,61
6,5	80	26	27	1265000	333,21
7	80	28	27	1270000	353,84
7,5	80	30	27	1275000	422,88
8	80	32	27	1280000	444,80
8,5	100	34	32	1285000	487,21
9	100	34	32	1290000	549,49
9,5	100	36	32	1295000	576,66
10	100	36	32	1210000	594,98

MOD 141



FRESA TIPO/TYPE	1	2	3	4	5	6	7	8
N°DENTI DA FRESARE NO. OF TEETH TO BE PRODUCED	12-13	14-16	17-20	21-25	26-34	35-54	55-134	135-00

MOD141

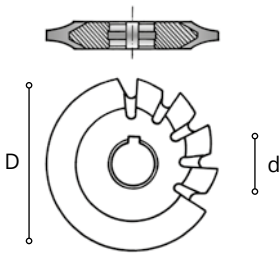

Mod. 141 dal modulo 6,5 al modulo 10 fino ad esaurimento
Mod. 141 from module 6,5 to module 10,00 until stocks last.

Mod	D js16	d H7	CODE	HSS+5%Co 1141..... €
0,5	40	160500 (1+8)	111,38
0,75	40	160750 (1+8)	111,38
1	50	160100 (1+8)	105,13
1,25	50	161250 (1+8)	116,30
1,5	63	221500 (1+8)	121,67
1,75	63	221750 (1+8)	138,36
2	63	222000 (1+8)	135,71
2,25	63	222250 (1+8)	149,40
2,5	63	222500 (1+8)	139,83
2,75	70	272750 (1+8)	187,70
3	70	273000 (1+8)	169,63
3,25	70	273250 (1+8)	191,61
3,5	80	273500 (1+8)	207,71
3,75	80	273750 (1+8)	237,51
4	80	274000 (1+8)	254,88
4,25	80	274250 (1+8)	305,34
4,5	90	274500 (1+8)	341,08
4,75	90	274750 (1+8)	341,08
5	90	325000 (1+8)	383,22
5,25	90	325250 (1+8)	444,93
5,5	90	325500 (1+8)	444,93
5,75	90	325750 (1+8)	487,22
6	100	326000 (1+8)	487,22
6,5	100	326500 (1+8)	549,01
7	110	327000 (1+8)	649,63
8	110	328000 (1+8)	698,32
9	125	409000 (1+8)	1136,85
10	125	401000 (1+8)	1136,85

ALL 156 ALU

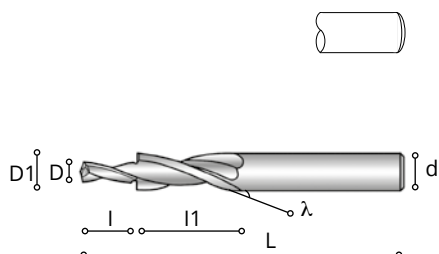

ALL156



D	D1	L	l	l1	d h8	Z	CODE	HSS+5%Co 4156..... €
6	12	83	13	35	10	261283	63,25
6	14	83	13	35	10	261483	66,68
5	12	100	15	35	10	251200	66,69
6	10	100	15	35	10	261000	66,68
6	11	100	15	35	10	261100	66,68
6	11,5	100	15	35	10	260011	66,68
6	12	100	15	35	10	261200	66,68
5,5	11,5	100	12	35	12	255115	66,68
6	11,5	100	12	35	12	260115	66,68
6,5	11,5	100	12	35	12	265115	66,68
6	12	100	12	35	12	261210	66,68
6,5	13,5	100	12	35	12	265135	75,61
6	11,5	122	18	45	12	261150	75,61
6	12	122	18	45	12	261212	75,61
6,5	11,5	122	18	45	12	265122	75,61
6,5	12	122	18	45	12	265012	75,61

FRESE A DUE TAGLIANTI PER LA LAVORAZIONE DI PROFILATI | PANTOGRAPH END MILLS

ALL 157 ALU

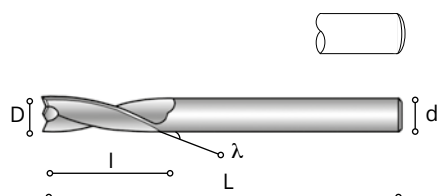

ALL157



D	L	l	d h8	Z	CODE	HSS+5%Co 4157..... €
4	55	14	6	240000	23,76
5	58	15	6	250000	23,76
3-6	65	10/15	6	236000	37,21

ALL 158 ALU

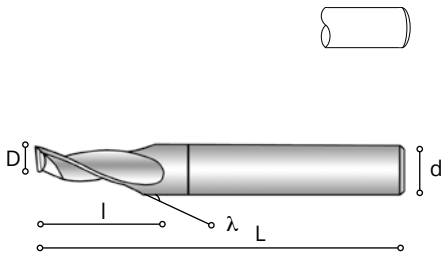

ALL158



D	L	I	d h8	Z	CODE	HSS+5%Co 4158..... €	CODE	HSS+5%Co 2158..... € SAPPHIRE MULTI
4	60	12	6	146000	29,3646002	36,96
5	60	15	6	156015	28,2956152	35,78
5	60	25	6	156000	32,5156002	40,41
6	60	15	6	166000	29,3666002	36,96
2,75/5	68	8/15	8	127550	41,8927552	51,62
3	68	12	8	130000	27,3630002	35,63
4	68	12	8	140000	26,6240002	34,82
5	68	15	8	150000	26,6258002	34,82
6	68	15	8	160000	26,6260002	34,82
7	68	15	8	170000	26,6270002	34,82
8	80	15	8	180000	26,6288002	36,31
10	80	15	8	110008	33,2010002	45,82
5	68	15	10	150010	28,2951002	37,88
6	68	15	10	160010	28,2961002	37,88
10	80	15	10	110080	37,3310012	49,48

ALL 158 ALU

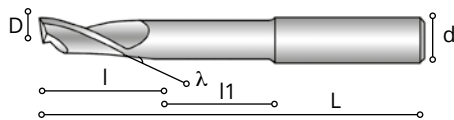

D	L	I	I1	d h8	Z	CODE	HSS+5%Co 4158..... €	CODE	HSS+5%Co 2158..... € SAPPHIRE MULTI
5	80	15	40	8	150080	31,3550802	41,53
6	80	15	40	8	160080	31,3560082	41,53
8	80	15	40	8	180080	31,3580802	41,53
8	95	18	50	8	180095	31,7989502	42,01
8	120	18	70	8	180120	33,2881202	45,31
10	95	18	50	8	110000	36,1710802	48,27
8	95	18	50	10	180010	39,5281002	51,89
10	95	18	50	10	110010	38,4510102	50,70
10	120	18	70	10	110120	39,5210122	54,26

ALL 160
ALU



ALL 164
ALU

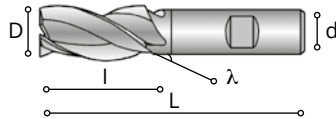

ALL160



ALL164



ALL160 D k10 ALL164 D k12	L	l	d h6	ALL160 Z	ALL164 Z	CODE	RESISTOR 4160..... €	RESISTOR 4164..... €
6	57	13	6	2	60030	24,04	
8	69	19	10	2	380030	31,30	48,43
10	72	22	10	3	310030	35,12	49,50
12	83	26	12	3	312030	42,06	59,11
14	83	26	12	3	14030	48,11	
16	92	32	16	3	316030	58,41	78,17
18	92	32	16	3	18030	71,98	
20	104	38	20	3	320030	95,10	112,76
25	121	45	25	3	325030	164,97	201,92
32	133	53	32	3	332030	280,23	294,67

ALL 162
ALU



ALL 166
ALU

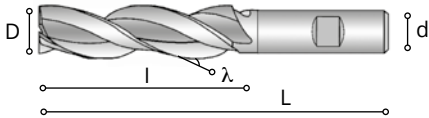

ALL162

















ALL166



ALL162 D k10 ALL166 D k12	L	l	d h6	ALL162 Z	ALL166 Z	CODE	RESISTOR 4162..... €	RESISTOR 4166..... €
6	68	24	6	2	60030	26,01	
8	88	38	10	2	80030	41,40	
10	95	45	10	3	310030	43,11	61,31
12	110	53	12	3	312030	52,72	74,31
16	123	63	16	3	316030	80,97	103,88
20	141	75	20	3	320030	127,30	145,29
25	166	90	25	3	325030	216,18	260,63
32	186	106	32	3	332030	330,63	402,59

Articolo Article	Tipo Type	Campo d'applicazione Application field	Angolo elica Point angle	Materiale tipo Tool material	Superficie Surface	Standard	Gamma dal diameter range	pag page
FRESE A DUE TAGLIANTI TWO FLUTE SLOT DRILLS								
 CL 11 HM	N	Acciai tenaci Hardened steel	30	MICROGRAIN CARBIDE Co10	White	DIN 6527 L DIN 6528	1 - 20	294
 CL 11 HM	N	Acciai tenaci Hardened steel	30	MICROGRAIN CARBIDE Co10	Sapphire	DIN 6527 L DIN 6528	1 - 20	294
 CL 11 HMB	N	Acciai tenaci Hardened steel	30	MICROGRAIN CARBIDE Co10	Sapphire	DIN 6527 L DIN 6528	3 - 20	295
 CL 11 Cr HM	N	Acciai tenaci Hardened steel	30	MICROGRAIN CARBIDE Co10	White	DIN 6527 L DIN 6528	2 - 20	296
 CL 11 Cr HM	N	Acciai tenaci Hardened steel	30	MICROGRAIN CARBIDE Co10	Sapphire	DIN 6527 L DIN 6528	2 - 20	296
 CL 11 Rs HM	N	Acciai tenaci Hardened steel	30	MICROGRAIN CARBIDE Co10	White	DIN 6527 K	2 - 5,5	297
 CL 11 Rs HM	N	Acciai tenaci Hardened steel	30	MICROGRAIN CARBIDE Co10	Sapphire	DIN 6527 K	2 - 5,5	297
 CL 12 HM	N	Acciai tenaci Hardened steel	30	MICROGRAIN CARBIDE Co10	White	CARMON NORM	3 - 20	298
 CL 12 HM	N	Acciai tenaci Hardened steel	30	MICROGRAIN CARBIDE Co10	Sapphire	CARMON NORM	3 - 20	298
 CL 18 HM	N	Acciai tenaci Hardened steel	30	MICROGRAIN CARBIDE Co10	White	DIN 6527 L DIN 6528	2 - 20	299
 CL 18 HM	N	Acciai tenaci Hardened steel	30	MICROGRAIN CARBIDE Co10	Sapphire	DIN 6527 L DIN 6528	2 - 20	299
 CL 18 SL HM	N	Acciai tenaci Hardened steel	30	MICROGRAIN CARBIDE Co10	White	CARMON NORM	3 - 20	300
 CL 18 SL HM	N	Acciai tenaci Hardened steel	30	MICROGRAIN CARBIDE Co10	Sapphire	CARMON NORM	3 - 20	300
FRESE A TRE TAGLIANTI THREE FLUTE SLOT DRILLS								
 CL 16 HM	N	Acciai tenaci Hardened steel	30	MICROGRAIN CARBIDE Co10	White	CARMON NORM	2 - 20	301
 CL 16 HM	N	Acciai tenaci Hardened steel	30	MICROGRAIN CARBIDE Co10	Sapphire	CARMON NORM	2 - 20	301
 CL 16 HMB	N	Acciai tenaci Hardened steel	30	MICROGRAIN CARBIDE Co10	Sapphire	DIN 6527 L DIN 6528	3 - 20	302
 CL 16 Cr HM	N	Acciai tenaci Hardened steel	30	MICROGRAIN CARBIDE Co10	White	DIN 6527 L DIN 6528	2 - 20	303
 CL 16 Cr HM	N	Acciai tenaci Hardened steel	30	MICROGRAIN CARBIDE Co10	Sapphire	DIN 6527 L DIN 6528	2 - 20	303

Articolo Article	Tipo Type	Campo d'applicazione Application field	Angolo elica Point angle	Materiale tipo Tool material	Superficie Surface	Standard	Gamma dal diameter range	pag page
 CL 16 RS HM	N	Acciai tenaci Hardened steel	30	MICROGRAIN CARBIDE Co10	White	DIN 6527 K	2 - 5,5	304
 CL 16 RS HM	N	Acciai tenaci Hardened steel	30	MICROGRAIN CARBIDE Co10	Sapphire	DIN 6527 K	2 - 5,5	304
 CL 16 R HM	N	Acciai tenaci Hardened steel	30	MICROGRAIN CARBIDE Co10	White	DIN 6527 L DIN 6528	2 - 20	305
 CL 16 R HM	N	Acciai tenaci Hardened steel	30	MICROGRAIN CARBIDE Co10	Sapphire	DIN 6527 L DIN 6528	2 - 20	305
 CL 17 HM	N	Acciai tenaci Hardened steel	30	MICROGRAIN CARBIDE Co10	White	CARMON NORM	3 - 20	306
 CL 17 HM	N	Acciai tenaci Hardened steel	30	MICROGRAIN CARBIDE Co10	Sapphire	CARMON NORM	3 - 20	306
 CL 17 R HM	N	Acciai tenaci Hardened steel	30	MICROGRAIN CARBIDE Co10	White	CARMON NORM	3 - 20	307
 CL 17 R HM	N	Acciai tenaci Hardened steel	30	MICROGRAIN CARBIDE Co10	Sapphire	CARMON NORM	3 - 20	307
FRESE A QUATTRO TAGLIANTI FOUR FLUTE SLOT DRILLS								
 CL 21 TF HM	N	Acciai tenaci Hardened steel	30	MICROGRAIN CARBIDE Co10	White	DIN 6527 L DIN 6528	2 - 20	308
 CL 21 TF HM	N	Acciai tenaci Hardened steel	30	MICROGRAIN CARBIDE Co10	Sapphire	DIN 6527 L DIN 6528	2 - 20	308
 CL 21 TF HMB	N	Acciai tenaci Hardened steel	30	MICROGRAIN CARBIDE Co10	Sapphire	DIN 6527 L DIN 6528	3 - 20	309
 CL 21 Cr HM	N	Acciai tenaci Hardened steel	30	MICROGRAIN CARBIDE Co10	White	DIN 6527 L DIN 6528	2 - 20	310
 CL 21 Cr HM	N	Acciai tenaci Hardened steel	30	MICROGRAIN CARBIDE Co10	Sapphire	DIN 6527 L DIN 6528	2 - 20	310
 CL 21 RS HM	N	Acciai tenaci Hardened steel	30	MICROGRAIN CARBIDE Co10	White	DIN 6527 K	2 - 5,5	311
 CL 21 RS HM	N	Acciai tenaci Hardened steel	30	MICROGRAIN CARBIDE Co10	Sapphire	DIN 6527 K	2 - 5,5	311
 CL 21 R HM	N	Acciai tenaci Hardened steel	30	MICROGRAIN CARBIDE Co10	White	DIN 6527 L DIN 6528	2 - 20	312
 CL 21 R HM	N	Acciai tenaci Hardened steel	30	MICROGRAIN CARBIDE Co10	Sapphire	DIN 6527 L DIN 6528	2 - 20	312
 CL 21 ED HM	N	Acciai tenaci Hardened steel	38 / 40	MICROGRAIN CARBIDE Co10	Sapphire Sleek	DIN 6527 L DIN 6528	5 - 20	313
 CL 22 ED HM	N	Acciai tenaci Hardened steel	38 / 40	MICROGRAIN CARBIDE Co10	Sapphire Sleek	DIN 6527 L DIN 6528	5 - 20	314

Articolo Article	Tipo Type	Campo d'applicazione Application field	Angolo elica Point angle	Materiale tipo Tool material	Superficie Surface	Standard	Gamma dal diameter range	pag page
 CL 22 TF HM	N	Acciai tenaci Hardened steel	30	MICROGRAIN CARBIDE Co10	White	CARMON NORM	3 - 20	135
 CL 22 TF HM	N	Acciai tenaci Hardened steel	30	MICROGRAIN CARBIDE Co10	Sapphire	CARMON NORM	3 - 20	315
 CL 22 R HM	N	Acciai tenaci Hardened steel	30	MICROGRAIN CARBIDE Co10	White	CARMON NORM	3 - 20	316
 CL 22 R HM	N	Acciai tenaci Hardened steel	30	MICROGRAIN CARBIDE Co10	Sapphire	CARMON NORM	M 3 - M 20	316
FRESE CILINDRICHE FRONTALI A SGRASSARE ROUGHING END MILLS								
 CL 24 TF PF HM	HR	Acciai tenaci Hardened steel	30	MICROGRAIN CARBIDE Co10	White	DIN 6528	6 - 20	317
 CL 24 TF PF HM	HR	Acciai tenaci Hardened steel	30	MICROGRAIN CARBIDE Co10	Sapphire	DIN 6528	6 - 20	317
 CL 25 TF HM	NF	Acciai tenaci Hardened steel	30	MICROGRAIN CARBIDE Co10	White	DIN 6528	6 - 20	317
 CL 25 TF HM	NF	Acciai tenaci Hardened steel	30	MICROGRAIN CARBIDE Co10	Sapphire	DIN 6528	6 - 20	317
FRESE CONICHE PER STAMPI DIESINKING MILLING CUTTERS								
 CS 47 HM	N	Acciai tenaci Hardened steel	30	MICROGRAIN CARBIDE Co10	White	CARMON NORM	1° - 5°	318
 CS 47 HM	N	Acciai tenaci Hardened steel	30	MICROGRAIN CARBIDE Co10	Sapphire	CARMON NORM	1° - 5°	318
FRESE MONOTAGLIANTE PER ALLUMINIO SINGLE FLUTE END MILLS FOR ALUMINUM								
 ALL 158 HM	W	Alluminio aluminium	30	MICROGRAIN CARBIDE Co10	White	CARMON NORM	3 - 12	319
 ALL 158 HM	W	Alluminio aluminium	30	MICROGRAIN CARBIDE Co10	Sapphire	CARMON NORM	3 - 12	319
FRESE IN METALLO DURO PER ALLUMINIO SOLID CARBIDE END MILLS FOR ALUMINUM								
 ALL 161 HM	W	Alluminio aluminium	45	MICROGRAIN CARBIDE Co10	White	DIN 6528	3 - 20	320
 ALL 161 HM	W	Alluminio aluminium	45	MICROGRAIN CARBIDE Co10	Sapphire	DIN 6528	3 - 20	320
 ALL 163 HM	W	Alluminio aluminium	45	MICROGRAIN CARBIDE Co10	White	DIN 6528	3 - 20	321
 ALL 163 HM	W	Alluminio aluminium	45	MICROGRAIN CARBIDE Co10	Sapphire	DIN 6528	3 - 20	321

Articolo Article	Tipo Type	Campo d'applicazione Application field	Angolo elica Point angle	Materiale tipo Tool material	Superficie Surface	Standard	Gamma dal diameter range	pag page
FRESE A DUE TAGLIENTI CON TESTA SEMISFERICA BALL NOSED TWO FLUTE END MILLS								
 CL 19 HM	HSC	Acciai temprati Tempered steels	30	MICROGRAIN CARBIDE Co12	Sapphire	CARMON NORM	1 - 20	322
 CL 19 CM HM	HSC	Acciai temprati Tempered steels	30	MICROGRAIN CARBIDE Co12	Sapphire	CARMON NORM	3 - 16	322
FRESE MULTITAGLIENTE PER SUPERFINITURA MULTIFLUTE SUPERFINISHING END MILLS								
 CL 26 HM	HSC	Acciai temprati Tempered steels	45	MICROGRAIN CARBIDE Co12	Sapphire	DIN 6528	6 - 20	323
 CL 26 SL HM	HSC	Acciai temprati Tempered steels	45	MICROGRAIN CARBIDE Co12	Sapphire	DIN 6528	6 - 20	323
FRESE TORICHE A QUATTRO TAGLIENTI FOUR FLUTE CUTTERS WITH CORNER RADIUS								
 CL 27 CR HM	HSC	Acciai temprati Tempered steels	30	MICROGRAIN CARBIDE Co12	Sapphire	CARMON NORM	3 - 16	324
 CL 27 CR SL HM	HSC	Acciai temprati Tempered steels	30	MICROGRAIN CARBIDE Co12	Sapphire	CARMON NORM	3 - 16	325
PUNTE ELICOIDALI IN METALLO DURO SOLID CARBIDE TWIST DRILLS								
PUNTE EXTRA CORTE TWIST DRILLS, STUB LENGHT								
 CL 400 HM	N	Acciai tenaci Hardened steel	118°	MICROGRAIN CARBIDE Co10	White	DIN 6539	2,00 - 13,00	326
 CL 400 HM	N	Acciai tenaci Hardened steel	118°	MICROGRAIN CARBIDE Co10	Sapphire	DIN 6539	2,00 - 13,00	326
PUNTE ELICOIDALI CORTE TWIST DRILLS JOBBER LENGTH								
 CL 410 HM	N	Acciai tenaci Hardened steel	118°	MICROGRAIN CARBIDE Co10	White	DIN 338	2,00 - 10,00	328
 CL 410 HM	N	Acciai tenaci Hardened steel	118°	MICROGRAIN CARBIDE Co10	Sapphire	DIN 338	2,00 - 10,00	328
PUNTE CON CODOLO RINFORZATO TWIST DRILLS WITH REINFORCED SHANK								
 CL 415 HM	N	Acciai tenaci Hardened steel	140°	MICROGRAIN CARBIDE Co10	Sapphire	DIN 6537K	3,00 -20,00	329
 CL 425 HM	N	Acciai tenaci Hardened steel	140°	MICROGRAIN CARBIDE Co10	Sapphire	DIN 6537K	3,00 -20,00	329
 CL 420 HM	N	Acciai tenaci Hardened steel	140°	MICROGRAIN CARBIDE Co10	Sapphire	DIN 6537L	3,00 -20,00	332
 CL 430 HM	N	Acciai tenaci Hardened steel	140°	MICROGRAIN CARBIDE Co10	Sapphire	DIN 6537L	3,00 -20,00	332
 CL 435 HM	N	Acciai tenaci Hardened steel	140°	MICROGRAIN CARBIDE Co10	Sapphire	CARMON NORM	3,00 -12,00	335



rpm
 $= (mt/min \times 1000) / (D \times 3,14)$



= mm/tooth
 (vedi tabella - see table page pag. 293)



= mt/min



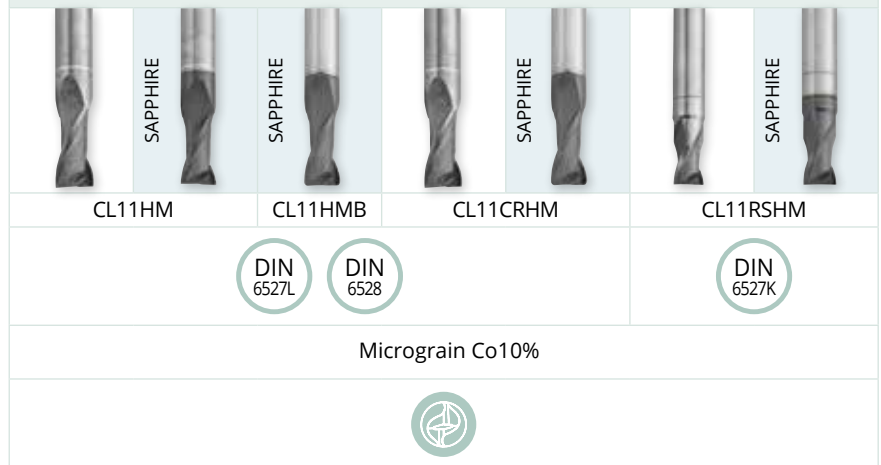



















FRESE A DUE TAGLIANTI TWO FLUTE END MILLS



Pag. 378	TIPO DI ACCIAIO TYPE OF STEEL		N/mm ²	HV	mt/min	mt/min	mt/min	mt/min	mt/min	mt/min	mt/min
ACCIAI COMUNI COMMON STEEL	Acciai teneri Soft steel	1	500	157	130	210	210	130	200	130	210
	Acciai da costruzione Structural steel	2	700	219	120	200	200	120	190	120	200
	Acciai da tempra Hardening steel	3	900	280	100	140	140	100	130	100	140
	Acciaio automatico Automatic steel	4	1200	373		75	75		60		75
ACCIAI INOX STAINLESS STEEL	Acciaio automatico Automatic steel	3	850	265	20	100	100	20	140	20	100
	Austenitico Austenitic	3	850	265	15	70	70	15	100	15	70
	Ferritico+austenitico Ferritic austenitic	4	1000	311		60	60		90		60
GHISA CAST IRON	Ghisa fino a 180 hb Cast iron up to 180hb	2	500	157	110	155	155	140	230	110	155
	Ghisa oltre 180 hb Cast iron over 180hb	3	700	219	50	80	80	90	140	50	80
TITANIO TITANIUM	Titanio non legato Unalloyed titanium	5	500	157	115	140	140	110	140	115	140
	Leghe di titanio Titanium alloys	5	900	280	70	90	90	70	90	70	90
RAME COPPER	Rame Copper	9	350	110	200	420	420			200	420
	Ottone Brass	9	700	219	200	420	420			200	420
	Bronzo Bronze	9	700	219	200	420	420			200	420
NICHEL NICKEL	Nichel non legato Unalloyed nichel	6	700	219	120	160	160	40	160	120	160
	Leghe di nichel Nichel alloys	6	900	280	10	30	30	10	30	10	30
ALLUMINIO ALUMINIUM	Alluminio non legato Unalloyed aluminium	7	350	110	200	300	300				
	Alluminio con leghe Alloyed aluminium	7	400	125	200	300	300				
	Alluminio con leghe Alloyed aluminium	7	500	157	300	600	600				

FRESE A DUE TAGLIENTI TWO FLUTE END MILLS

FRESE A TRE TAGLIENTI THREE FLUTE END MILLS

FRESE A DUE TAGLIENTI TWO FLUTE END MILLS						FRESE A TRE TAGLIENTI THREE FLUTE END MILLS					
											
CL12HM		CL18HM		CL18SLHM		CL16HM		CL16HMB	CL16CRHM		
											
Micrograin Co10%						Micrograin Co10%					
											
mt/min	mt/min	mt/min	mt/min	mt/min	mt/min	mt/min	mt/min	mt/min	mt/min	mt/min	
130	210	120	200	120	200	130	210	210	130	200	
120	200	110	190	110	190	120	200	200	120	190	
100	140	90	130	90	130	100	140	140	100	130	
	75		60		60		75	75		60	
20	100	20	140	20	140	20	100	100	20	140	
15	70	15	100	15	100	15	70	70	15	100	
	60		90		90		60	60		90	
110	155	140	230	140	230	110	155	155	140	230	
50	80	90	140	90	140	50	80	80	90	140	
115	140	110	140	110	140	115	140	140	110	140	
70	90	70	90	70	90	70	90	90	70	90	
200	420					200	420	420			
200	420					200	420	420			
200	420					200	420	420			
120	160	40	160	40	160	120	160	160	40	160	
10	30	10	30	10	30	10	30	30	10	30	
200	300					200	300	300			
200	300					200	300	300			
300	600					300	600	600			



rpm
 $= (\text{mt/min} \times 1000) / (D \times 3,14)$



= mm/tooth
 (vedi tabella - see table page pag. 293)



= mt/min



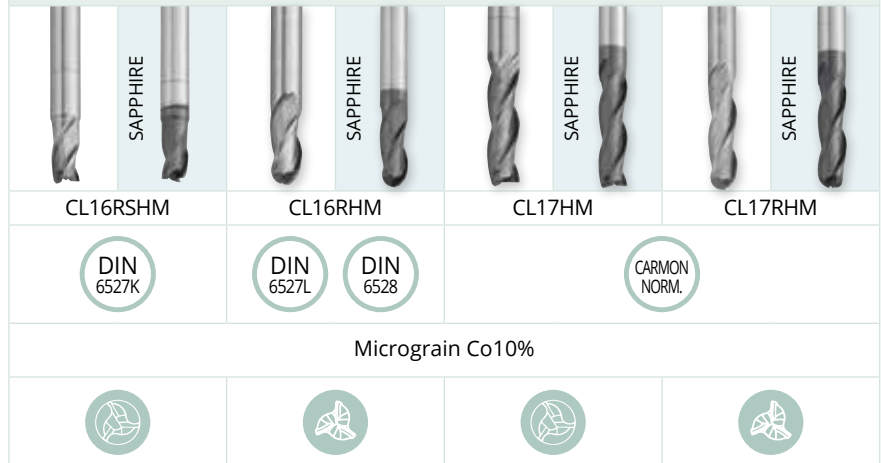





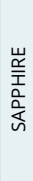
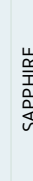

FRESE A TRE TAGLIANTI THREE FLUTE END MILLS

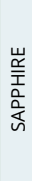

Pag. 378	TIPO DI ACCIAIO TYPE OF STEEL	N/mm ²	HV	CL16RSHM		CL16RHM		CL17HM		CL17RHM	
				mt/min	mt/min	mt/min	mt/min	mt/min	mt/min	mt/min	mt/min
ACCIAI COMUNI COMMON STEEL	Acciai teneri Soft steel	1	500	130	210	120	200	130	210	120	200
	Acciai da costruzione Structural steel	2	700	120	200	110	190	120	200	110	190
	Acciai da tempra Hardening steel	3	900	280	100	140	90	130	100	140	90
	Acciaio automatico Automatic steel	4	1200	373		75		60		75	
ACCIAI INOX STAINLESS STEEL	Acciaio automatico Automatic steel	3	850	265	20	100	20	140	20	100	20
	Austenitico Austenitic	3	850	265	15	70	15	100	15	70	15
	Ferritico+austenitico Ferritic austenitic	4	1000	311		60		90		60	
GHISA CAST IRON	Ghisa fino a 180 hb Cast iron up to 180hb	2	500	157	110	155	140	230	110	155	140
	Ghisa oltre 180 hb Cast iron over 180hb	3	700	219	50	80	90	140	50	80	90
TITANIO TITANIUM	Titanio non legato Unalloyed titanium	5	500	157	115	140	110	140	115	140	110
	Leghe di titanio Titanium alloys	5	900	280	70	90	70	90	70	90	70
RAME COPPER	Rame Copper	9	350	110	200	420			200	420	
	Ottone Brass	9	700	219	200	420			200	420	
	Bronzo Bronze	9	700	219	200	420			200	420	
NICHEL NICKEL	Nichel non legato Unalloyed nichel	6	700	219	120	160	40	160	120	160	40
	Leghe di nichel Nichel alloys	6	900	280	10	30	10	30	10	30	10
ALLUMINIO ALUMINIUM	Alluminio non legato Unalloyed aluminium	7	350	110					200	300	
	Alluminio con leghe Alloyed aluminium	7	400	125					200	300	
	Alluminio con leghe Alloyed aluminium	7	500	157					300	600	

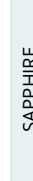
FRESE A QUATTRO TAGLIANTI FOUR FLUTE END MILLS

FRESE A QUATTRO TAGLIANTI CON ELICA DIFFERENZIATA E DIVISIONE IRREGOLARE FOUR FLUTE END MILLS WITH HELIX DIFFERENTIATED IRREGULAR DIVISION

FRESE A QUATTRO TAGLIANTI FOUR FLUTE END MILLS						FRESE A QUATTRO TAGLIANTI CON ELICA DIFFERENZIATA E DIVISIONE IRREGOLARE FOUR FLUTE END MILLS WITH HELIX DIFFERENTIATED IRREGULAR DIVISION									
															
CL21TFHM		CL21TFHM		CL21CRHM		CL21RSHM		CL21RHM		CL21EDHM		CL22EDHM			
DIN 6527L		DIN 6528				DIN 6527K		DIN 6527L		DIN 6528		DIN 6527L		DIN 6528	
Micrograin Co10%															
															
mt/min	mt/min	mt/min	mt/min	mt/min	mt/min	mt/min	mt/min	mt/min	mt/min	mt/min	mt/min	mt/min	mt/min		
130	210	210	130	200	130	210	120	200	250	175					
120	200	200	120	190	120	200	110	190	240	170					
100	140	140	100	130	100	140	90	130	170	120					
	75	75		60		75		60	90	60					
20	140	140	20	140	20	100	20	140	170	120					
15	100	100	15	100	15	70	15	100	120	85					
	90	90		90		60		90	110	75					
120	230	230	140	230	110	155	140	230	280	200					
80	140	140	90	140	50	80	90	140	170	120					
115	140	140	110	140	115	140	110	140	170	120					
70	90	90	70	90	70	90	70	90	110	75					
200	420	420			200	420			500	350					
200	420	420			200	420			500	350					
200	420	420			200	420			500	350					
120	160	160	40	160	120	160	40	160	200	140					
10	30	30	10	30	10	30	10	30	40	30					
200	300	300													
200	300	300													
300	600	600													



rpm
 $= (\text{mt/min} \times 1000) / (D \times 3,14)$



= mm/tooth
 (vedi tabella - see table page pag. 293)









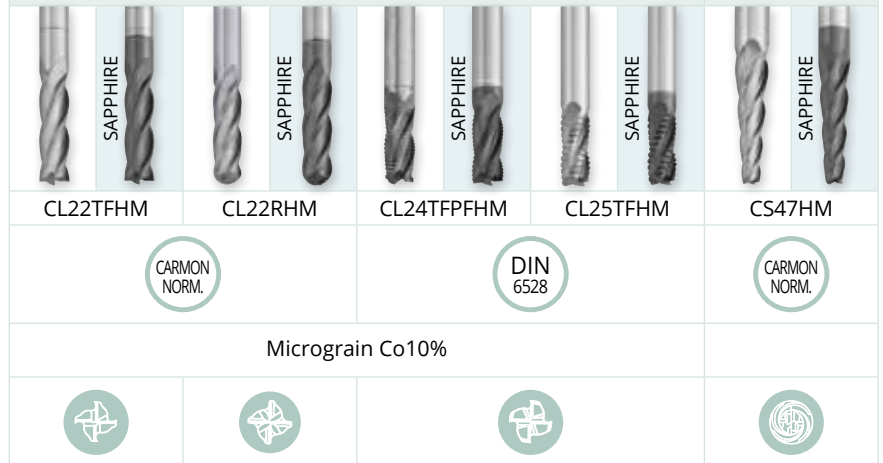









= mt/min

FRESE A QUATTRO TAGLIANTI FOUR FLUTE END MILLS

FRESE CONICHE PER STAMPI DIESINKING MILLING CUTTERS



Pag. 378	TIPO DI ACCIAIO TYPE OF STEEL	N/mm ²	HV	CL22TFHM		CL22RHM		CL24TFPFHM		CL25TFHM		CS47HM	
				mt/min	mm/tooth	mt/min	mm/tooth	mt/min	mm/tooth	mt/min	mm/tooth	mt/min	mm/tooth
ACCIAI COMUNI COMMON STEEL	Acciai teneri Soft steel	1	500	130	210	120	200	130	210	130	210	130	210
	Acciai da costruzione Structural steel	2	700	120	200	110	190	120	200	120	200	120	200
	Acciai da tempra Hardening steel	3	900	100	140	90	130	100	140	100	140	100	140
	Acciaio automatico Automatic steel	4	1200		75		60		75		75		75
ACCIAI INOX STAINLESS STEEL	Acciaio automatico Automatic steel	3	850	20	140	20	140	20	140	20	140	20	140
	Austenitico Austenitic	3	850	15	100	15	100	15	100	15	100	15	100
	Ferritico+austenitico Ferritic austenitic	4	1000		90		90		90		90		90
GHISA CAST IRON	Ghisa fino a 180 hb Cast iron up to 180hb	2	500	120	230	140	230	120	230	120	230	120	230
	Ghisa oltre 180 hb Cast iron over 180hb	3	700	80	140	90	140	80	140	80	140	80	140
TITANIO TITANIUM	Titanio non legato Unalloyed titanium	5	500	115	140	110	140	115	140	115	140	115	140
	Leghe di titanio Titanium alloys	5	900	70	90	70	90	70	90	70	90	70	90
RAME COPPER	Rame Copper	9	350	110	200	420		200	420	200	420	200	420
	Ottone Brass	9	700	219	200	420		200	420	200	420	200	420
	Bronzo Bronze	9	700	219	200	420		200	420	200	420	200	420
NICHEL NICKEL	Nichel non legato Unalloyed nichel	6	700	219	120	160	40	160	120	160	120	160	120
	Leghe di nichel Nichel alloys	6	900	280	10	30	10	30	10	30	10	30	10
ALLUMINIO ALUMINIUM	Alluminio non legato Unalloyed aluminium	7	350	110	200	300		200	300	200	300	200	300
	Alluminio con leghe Alloyed aluminium	7	400	125	200	300		200	300	200	300	200	300
	Alluminio con leghe Alloyed aluminium	7	500	157	300	600		300	600	300	600	300	600

FRESE MONOTAGLIENTE PER ALLUMINIO SINGLE FLUTE END MILLS FOR ALUMINUM		FRESE IN METALLO DURO PER ALLUMINIO SOLID CARBIDE END MILLS FOR ALUMINUM				FRESE A DUE TAGLIANTI TWO FLUTE END MILLS		FRESE MULTITAGLIENTE PER SUPERFINITURA MULTIFLUTE SUPERFINISHING END MILLS		FRESE TORICHE A QUATTRO TAGLIANTI FOUR FLUTE CUTTERS WITH CORNER RADIUS	
	SAPPHIRE										
ALL158HM		ALL161HM		ALL163HM		CL19HM	CL19CMHM	CL26HM	CL26SLHM	CL27CRHM	CL27CRSLHM
CARMON NORM.		DIN 6528				CARMON NORM.		DIN 6528		CARMON NORM.	
		Micrograin Co10%				Micrograin Co12%		Micrograin Co12%			
											
mt/min	mt/min	mt/min	mt/min	mt/min	mt/min	mt/min	mt/min	mt/min	mt/min	mt/min	mt/min
						310	310	310	310	310	310
						300	300	300	300	300	300
						220	220	220	220	220	220
						70	70	70	70	70	70
		20	100	20	100	200	200	200	200	200	200
		15	70	15	70	150	150	150	150	150	150
			60		60	100	100	100	100	100	100
		110	155	110	155	290	290	290	290	290	290
		50	80	50	80	180	180	180	180	180	180
		115	140	115	140	200	200	200	200	200	200
		70	90	70	90	120	120	120	120	120	120
		200	420	200	420						
		200	420	200	420						
		200	420	200	420						
				120	160	230	230	230	230	230	230
				10	30	50	50	50	50	50	50
220	320	200	300	200	300						
220	320	200	300	200	300						
300	600	300	600	300	600						



rpm
 $= (mt/min \times 1000) / (D \times 3,14)$



mm/min
 $= mm/rev \times rpm$



= mt/min



= mm/rev
 (vedi tabella - see table page pag. 293)

PUNTE EXTRA CORTE TWIST DRILLS, STUB LENGTH		PUNTE CORTE TWIST DRILLS, JOBBER LENGTH		PUNTE CON CODOLO RINFORZATO TWIST DRILLS WITH REINFORCED SHANK									
	SAPPHIRE		SAPPHIRE										
CL400		CL410		CL415	CL425	CL420	CL430	CL435					
DIN 6539		DIN 338		DIN 6537K	DIN 6537K	DIN 6537L	DIN 6537L	DIN 6537L	CARMON NORM.				
HM		HM		HM									

Pag. 378	TIPO DI ACCIAIO TYPE OF STEEL	N/mm ²	HV	mt/min		mt/min		mt/min		mt/min		mt/min		mt/min	
				mm/rev	mm/rev	mm/rev	mm/rev	mm/rev	mm/rev	mm/rev	mm/rev	mm/rev	mm/rev		
ACCIAI COMUNI COMMON STEEL	Acciai teneri Soft steel	1	500	157	85 a	120 f	85 a	120 f	120 c	150 c	120 c	150 c	150 c	150 c	150 c
	Acciai da costruzione Structural steel	2	700	219	70 a	115 f	70 a	115 f	100 b	120 b	100 b	120 b	120 b	120 b	120 b
	Acciai da tempra Hardening steel	3	900	280	45 a	90 f	45 a	90 f	80 b	100 b	80 b	100 b	100 b	100 b	100 b
	Acciaio automatico Automatic steel	4	1200	373	40 a	50 f	40 a	50 f	60 a	70 a	60 a	70 a	70 a	70 a	70 a
ACCIAI INOX STAINLESS STEEL	Acciaio automatico Automatic steel	3	850	265	50 g	55 f	50 g	55 f	70 c	80 c	70 c	80 c	80 c	80 c	80 c
	Austenitico Austenitic	3	850	265	45 g	50 f	45 g	50 f	60 c	70 c	60 c	70 c	70 c	70 c	70 c
	Ferritico+austenitico Ferritic austenitic	4	1000	311					40 e	50 e	40 e	50 e	50 e	50 e	50 e
GHISA CAST IRON	Ghisa fino a 180 hb Cast iron up to 180hb	2	500	157	75 b	90 f	75 b	90 f	75 c	75 c	80 c	80 c	80 c	80 c	80 c
	Ghisa oltre 180 hb Cast iron over 180hb	3	700	219	55 b	70 f	55 b	70 f	65 b	65 b	65 b	65 b	65 b	65 b	65 b
TITANIO TITANIUM	Titanio non legato Unalloyed titanium	5	500	157	45 a	55 a	45 a	55 a	55 c	65 c	55 c	65 c	65 c	65 c	65 c
	Leghe di titanio Titanium alloys	5	900	280	30 a	40 a	30 a	40 a	45 b	55 b	45 b	55 b	55 b	55 b	55 b
RAME COPPER	Rame Copper	9	350	110	300 f		300 f								
	Ottone Brass	9	700	219	300 f		300 f								
	Bronzo Bronze	9	700	219	300 f		300 f								
NICHEL NICKEL	Nichel non legato Unalloyed nichel	6	700	219	45 a	55 f	45 a	55 f	40 b	50 b	40 b	50 b	50 b	50 b	50 b
	Leghe di nichel Nichel alloys	6	900	280	30 a	45 f	30 a	45 f	30 a	40 a	30 a	40 a	40 a	40 a	40 a
ALLUMINIO ALUMINIUM	Alluminio non legato Unalloyed aluminium	7	350	110											
	Alluminio con leghe Alloyed aluminium	7	400	125											
	Alluminio con leghe Alloyed aluminium	7	500	157											

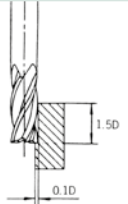
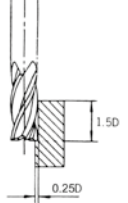
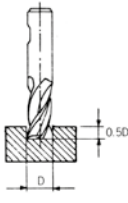
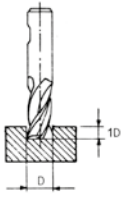
FRESATURA MILLING	TABELLA PARAMETRI DI AVANZAMENTO mm/dente FEED DATA mm/tooth.											
	DIAMETRO DELLA FRESA MILLING DIAMETER											
TIPO DI FRESATURA TYPE OF MILLING	2	3	4	5	6	8	10	12	14	16	18	20
	0,016	0,025	0,035	0,040	0,065	0,070	0,080	0,095	0,100	0,120	0,140	0,160
	0,013	0,025	0,030	0,040	0,050	0,055	0,060	0,070	0,080	0,090	0,100	0,120
	0,007	0,009	0,012	0,014	0,016	0,022	0,035	0,045	0,055	0,065	0,070	0,075
	0,004	0,008	0,010	0,013	0,015	0,025	0,035	0,040	0,045	0,050	0,055	0,060

FORATURA DRILLING	TABELLA PARAMETRI DI AVANZAMENTO mm/giro RECOMMENDED FEED DATA mm/rev.																
	DIAMETRO DELLA PUNTA DRILL DIAMETER																
LETTERA DI RIFERIMENTO REFERENCE LETTER	D. 1	D. 2	D. 3	D. 4	D. 5	D. 6	D. 8	D. 10	D. 12	D. 14	D. 16	D. 20	D. 25	D. 30	D. 35	D. 40	D. 50
a	0,015	0,030	0,038	0,047	0,053	0,060	0,075	0,090	0,100	0,120	0,127	0,160	0,200	0,230	0,250	0,300	0,350
b	0,020	0,050	0,070	0,085	0,100	0,120	0,150	0,180	0,200	0,230	0,250	0,270	0,290	0,330	0,350	0,380	0,400
c	0,023	0,080	0,100	0,130	0,150	0,180	0,250	0,270	0,280	0,300	0,330	0,370	0,420	0,450	0,470	0,500	0,550
d	0,030	0,100	0,160	0,180	0,220	0,240	0,300	0,370	0,400	0,450	0,480	0,500	0,530	0,550	0,580	0,600	0,630
e	0,035	0,120	0,200	0,250	0,270	0,300	0,350	0,450	0,470	0,500	0,530	0,550	0,600	0,640	0,680	0,700	0,730
f	0,050	0,150	0,220	0,250	0,320	0,400	0,490	0,620	0,650	0,720	0,850	0,900	1,100	1,130	1,170	1,200	1,250
g	0,070	0,160	0,250	0,270	0,360	0,470	0,620	0,830	0,900	0,950	1,100	1,200	1,280	1,330	1,400	1,470	1,520
h	0,090	0,200	0,270	0,300	0,400	0,520	0,750	1,000	1,100	1,200	1,300	1,350	1,430	1,500	1,650	1,700	1,800

CL 11HM

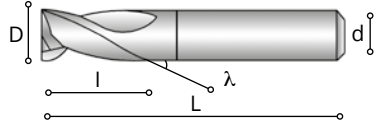
LASER RING I[®]

CL11HM



D h10	L	l	d h6	Z	CODE	Micrograin Carbide Co10		Micrograin Carbide Co10
						1110..... €	CODE	2110..... € SAPPHIRE
1	40	3	4	201009	22,1801008	27,71
1,5	40	4,5	4	201509	21,5401508	27,01
2	38	6	3	202009	18,6802008	22,90
2,5	38	7	3	225009	19,3225008	25,43
3	38	7	3	230009	20,0030008	25,03
3,5	50	7	3,5	235009	20,3635008	25,83
4	50	8	4	240009	18,6640008	23,43
4,5	50	8	4,5	245009	23,9445008	30,86
5	50	10	5	250009	21,6350008	28,27
5,5	57	10	5,5	255009	26,7655008	33,97
6	57	10	6	260009	24,8260008	31,91
7	60	13	7	270009	31,4670008	39,99
8	63	16	8	280009	39,1180008	48,39
9	67	16	9	290009	48,4390008	59,96
10	72	19	10	210009	55,1210008	64,52
12	83	22	12	212009	77,8712008	91,04
14	83	22	14	214009	103,1414008	121,50
16	92	26	16	216009	140,5116008	162,61
18	92	26	18	218009	173,7218008	200,42
20	104	32	20	220009	225,8520008	264,25

CL 11 HMB

DIN
6527L

DIN
6528

N

λ
30°

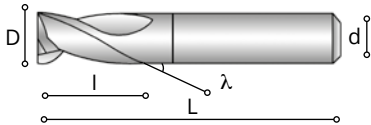

CL11HMB



D h10	L	l	d h6	Z	CODE	Micrograin Carbide Co10
						2110..... € SAPPHIRE SLEEK
3,00	50	7	3,00	230008B	17,52
3,50	50	7	3,50	235008B	18,08
4,00	50	8	4,00	240008B	16,40
4,50	50	8	4,50	245008B	21,60
5,00	50	10	5,00	250008B	19,79
5,50	57	10	5,50	255008B	23,78
6,00	57	10	6,00	260008B	22,34
6,50	60	13	6,50	265008B	25,01
7,00	60	13	7,00	270008B	27,99
7,50	63	16	7,50	275008B	31,35
8,00	63	16	8,00	280008B	33,87
8,50	67	16	8,50	285008B	37,94
9,00	67	16	9,00	290008B	41,97
9,50	72	19	9,50	295008B	47,43
10,00	72	19	10,00	210008B	45,16
10,50	72	19	10,50	210508B	51,93
11,00	83	22	11,00	211008B	63,89
12,00	83	22	12,00	212008B	63,73
13,00	83	22	13,00	213008B	80,60
14,00	83	22	14,00	214008B	86,75
15,00	92	22	15,00	215008B	106,32
16,00	92	26	16,00	216008B	122,42
17,00	92	26	17,00	217008B	152,16
18,00	92	26	18,00	218008B	160,95
19,00	92	26	19,00	219008B	197,00
20,00	104	32	20,00	220008B	203,34

CL 11CrHM

DIN
6527LDIN
6528

N

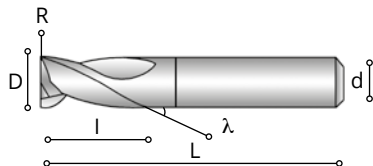
 λ
30°LASER RING I® 

CL11CrHM



D h10	R	L	I	d h6	Z	CODE	Micrograin Carbide Co10	CODE	Micrograin Carbide Co10
							1110..... €		2110..... € SAPPHIRE
2	0,3	38	6	3	202019	20,5502018	25,19
3	0,3	38	7	3	230019	22,0030018	27,53
4	0,5	50	8	4	240019	20,5340018	25,77
5	0,5	50	10	5	250019	23,7950018	31,10
6	0,5	57	10	6	260019	27,3060018	35,10
7	0,8	60	13	7	270019	34,6170018	43,99
8	0,8	63	16	8	280019	43,0280018	53,23
9	0,8	67	16	9	290019	53,2790018	65,96
10	1	72	19	10	210019	60,6310018	70,97
12	1	83	22	12	212019	87,2112018	100,14
14	1	83	22	14	214019	115,5114018	137,65
16	1,5	92	26	16	216019	157,3816018	184,24
18	1,5	92	26	18	218019	194,5718018	227,07
20	2	104	32	20	220019	252,9620018	299,40

Altri raggi a richiesta - We can manufacture on request these cutters with different corner radius size

CL 11RsHM 



LASER RING I 

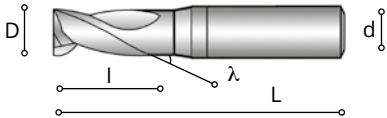

CL11RsHM



D h10	L	l	d h6	Z	CODE	Micrograin Carbide Co10	CODE	Micrograin Carbide Co10
						1110..... €		2110..... € SAPPHIRE
2	50	3	6	202029	30,4002028	37,97
2,5	50	3	6	225029	30,4025028	37,97
3	50	4	6	230029	30,4030028	37,97
3,5	50	4	6	235029	30,4035028	37,97
4	54	5	6	240029	30,4040028	37,97
4,5	54	5	6	245029	30,4045028	37,97
5	54	6	6	250029	30,4050028	37,97
5,5	54	7	6	255029	30,4055028	37,97

CL 12HM

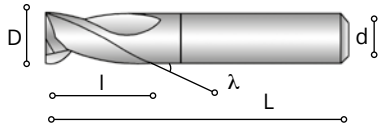
LASER RING I[®]

CL12HM



D h10	L	I	d h6	Z	CODE	Micrograin Carbide Co10		Micrograin Carbide Co10
						1120..... €	CODE	2120..... € SAPPHIRE
3	55	14	3	230009	24,7630008	31,41
4	55	16	4	240009	26,6940008	33,06
5	60	20	5	250009	28,6650008	36,28
6	70	20	6	260009	33,2660008	41,18
7	75	26	7	270009	47,9170008	58,64
8	80	32	8	280009	56,5280008	69,12
9	80	32	9	290009	64,7490008	79,62
10	100	36	10	210009	80,2010008	93,85
12	100	40	12	212009	118,2712008	125,72
14	100	45	14	214009	184,0314008	188,40
16	120	52	16	216009	205,9816008	248,20
18	120	52	18	218009	261,7718008	298,47
20	130	64	20	220009	396,1920008	420,98

CL 18HM



LASER RING I[®]

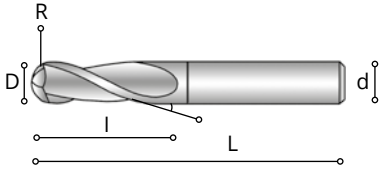

CL18HM



D h10	R ±0,02	L	I	d h6	Z	CODE	Micrograin Carbide Co10		
							1180..... €	CODE	
							Micrograin Carbide Co10		
							2180..... € SAPPHIRE		
2	1	38	6	3	202009	29,7902008	35,93
3	1,5	38	7	3	230009	25,7430008	30,61
4	2	50	8	4	240009	29,4840008	34,02
5	2,5	50	10	5	250009	34,0350008	40,39
6	3	57	10	6	260009	34,3460008	41,03
7	3,5	60	13	7	270009	50,3870008	58,56
8	4	63	16	8	280009	47,5380008	55,52
9	4,5	67	16	9	290009	74,4590008	89,72
10	5	72	19	10	210009	72,2810008	81,06
12	6	83	22	12	212009	89,5512008	105,94
14	7	83	22	14	214009	125,5414008	146,31
16	8	92	26	16	216009	157,5216008	175,43
18	9	92	26	18	218009	209,7018008	240,42
20	10	104	32	20	220009	265,5420008	291,29

CL 18SLHM

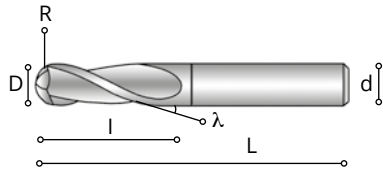
LASER RING I[®]

CL18SLHM



D h10	R ± 0,02	L	I	d h6	Z	CODE	Micrograin Carbide Co10		Micrograin Carbide Co10
							1182..... €	CODE	2182..... € SAPPHIRE
3	1,5	55	14	3	230009	41,9330008	49,14
4	2	55	16	4	240009	43,8540008	48,61
5	2,5	60	20	5	250009	48,2150008	57,32
6	3	70	20	6	260009	53,1260008	61,72
7	3,5	75	26	7	270009	69,8870008	82,59
8	4	80	32	8	280009	69,8880008	82,59
9	4,5	80	32	9	290009	99,4790008	109,37
10	5	100	36	10	210009	99,4710008	109,37
12	6	100	40	12	212009	135,0312008	142,29
14	7	100	45	14	214009	191,3714008	219,69
16	8	120	52	16	216009	257,9316008	295,23
18	9	120	52	18	218009	307,0418008	360,02
20	10	130	64	20	220009	409,5920008	464,21

CL 16HM



LASER RING I® 

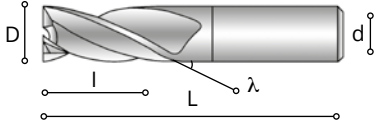

CL16HM



D h10	L	I	d h6	Z	CODE	Micrograin Carbide Co10		
						1160..... €	CODE	
						Micrograin Carbide Co10		
						2160..... € SAPPHIRE		
2	38	6	3	302009	18,6802008	22,90
3	38	7	3	330009	20,0030008	25,03
4	50	8	4	340009	18,6640008	23,43
5	50	10	5	350009	21,6350008	28,27
6	57	10	6	360009	24,8260008	31,91
7	60	13	7	370009	31,4670008	39,99
8	63	16	8	380009	39,1180008	48,39
9	67	16	9	390009	48,4390008	59,96
10	72	19	10	310009	55,1210008	64,52
12	83	22	12	312009	77,8712008	91,04
14	83	22	14	314009	103,1414008	121,50
16	92	26	16	316009	140,5116008	162,61
18	92	26	18	318009	173,7218008	200,42
20	104	32	20	320009	225,8520008	264,25

CL 16 HMB

DIN
6527LDIN
6528

N

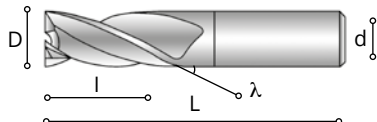
 λ
30°

CL16HMB



D h10	L	l	d h6	Z	CODE	Micrograin Carbide Co10
						2160..... € SAPPHIRE SLEEK
3,00	50	7	3,00	330008B	17,52
3,50	50	7	3,50	335008B	19,49
4,00	50	8	4,00	340008B	16,40
4,50	50	8	4,50	345008B	23,08
5,00	50	10	5,00	350008B	19,79
5,50	57	10	5,50	355008B	25,71
6,00	57	10	6,00	360008B	22,34
6,50	60	13	6,50	365008B	25,56
7,00	60	13	7,00	370008B	28,00
7,50	63	16	7,50	375008B	31,81
8,00	63	16	8,00	380008B	33,87
8,50	67	16	8,50	385008B	38,40
9,00	67	16	9,00	390008B	41,97
9,50	72	19	9,50	395008B	47,92
10,00	72	19	10,00	310008B	45,16
10,50	72	19	10,50	310508B	52,39
11,00	83	22	11,00	311008B	65,48
12,00	83	22	12,00	312008B	63,73
13,00	83	22	13,00	313008B	82,55
14,00	83	22	14,00	314008B	86,75
15,00	92	22	15,00	315008B	108,01
16,00	92	26	16,00	316008B	122,42
17,00	92	26	17,00	317008B	152,16
18,00	92	26	18,00	318008B	160,95
19,00	92	26	19,00	319008B	197,00
20,00	104	32	20,00	320008B	203,34

CL 16CrHM



LASER RING I®

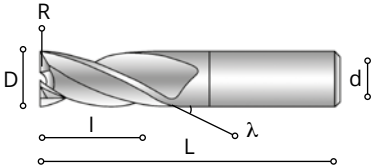

CL16CrHM



D h10	R	L	I	d h6	Z	CODE	Micrograin Carbide Co10	CODE	Micrograin Carbide Co10
							1160..... €		2160..... € SAPPHIRE
2	0,3	38	6	3	302019	20,5502018	25,19
3	0,3	38	7	3	330019	22,0030018	27,53
4	0,5	50	8	4	340019	20,5340018	25,77
5	0,5	50	10	5	350019	23,7950018	31,10
6	0,5	57	10	6	360019	27,3060018	35,10
7	0,8	60	13	7	370019	34,6170018	43,99
8	0,8	63	16	8	380019	43,0280018	53,23
9	0,8	67	16	9	390019	53,2790018	65,96
10	1	72	19	10	310019	60,6310018	70,97
12	1	83	22	12	312019	87,2112018	100,14
14	1	83	22	14	314019	115,5114018	137,65
16	1,5	92	26	16	316019	157,3816018	184,24
18	1,5	92	26	18	318019	194,5718018	227,07
20	2	104	32	20	320019	252,9620018	299,40

Altri raggi a richiesta - We can manufacture on request these cutters with different corner radius size

CL 16RsHM

DIN
6527K

N

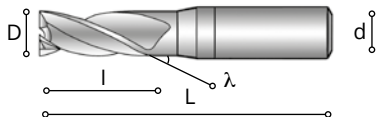
 λ
30°LASER RING I[®] (DIN 6535
Form HA)

CL16RsHM



D h10	L	l	d h6	Z	CODE	Micrograin Carbide Co10		Micrograin Carbide Co10
						1160..... €	CODE	2160..... € SAPPHIRE
2	50	3	6	302029	30,4002028	37,97
2,5	50	3	6	325029	30,4025028	37,97
3	50	4	6	330029	30,4030028	37,97
3,5	50	4	6	335029	30,4035028	37,97
4	54	5	6	340029	30,4040028	37,97
4,5	54	5	6	345029	30,4045028	37,97
5	54	6	6	350029	30,4050028	37,97
5,5	54	7	6	355029	30,4055028	37,97

CL 16RHM



LASER RING I[®]

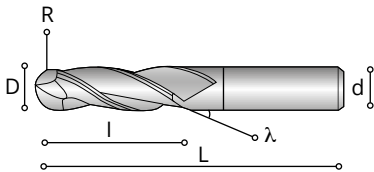

CL16RHM



D h10	R ± 0,02	L	l	d h6	Z	CODE	Micrograin Carbide Co10		
							1161..... €	CODE	
							Micrograin Carbide Co10		
							2161..... € SAPPHIRE		
2	1	38	6	3	302009	29,7902008	35,93
3	1,5	38	7	3	330009	25,7430008	30,61
4	2	50	8	4	340009	29,4840008	34,02
5	2,5	50	10	5	350009	34,0350008	40,39
6	3	57	10	6	360009	34,3460008	41,03
7	3,5	60	13	7	370009	50,3870008	58,56
8	4	63	16	8	380009	47,5380008	55,52
9	4,5	67	16	9	390009	74,4590008	89,72
10	5	72	19	10	310009	72,2810008	81,06
12	6	83	22	12	312009	89,5512008	105,94
14	7	83	22	14	314009	125,5414008	146,31
16	8	92	26	16	316009	157,5216008	175,43
18	9	92	26	18	318009	209,7018008	240,42
20	10	104	32	20	320009	265,5420008	291,29

CL 17HM

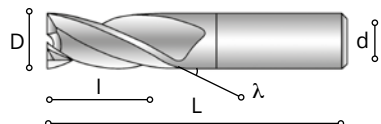
LASER RING I[®]

CL17HM



D h10	L	l	d h6	Z	CODE	Micrograin Carbide Co10		Micrograin Carbide Co10
						1170..... €	CODE	2170..... € SAPPHIRE
3	55	14	3	330009	24,7630008	31,41
4	55	16	4	340009	26,6940008	33,06
5	60	20	5	350009	28,6650008	36,28
6	70	20	6	360009	33,2660008	41,18
7	75	26	7	370009	47,9170008	58,64
8	80	32	8	380009	56,5280008	69,12
9	80	32	9	390009	64,7490008	79,62
10	100	36	10	310009	80,2010008	93,85
12	100	40	12	312009	118,2712008	125,72
14	100	45	14	314009	184,0314008	188,40
16	120	52	16	316009	205,9816008	248,20
18	120	52	18	318009	261,7718008	298,47
20	130	64	20	320009	396,1920008	420,98

CL 17RHM



LASER RING I®

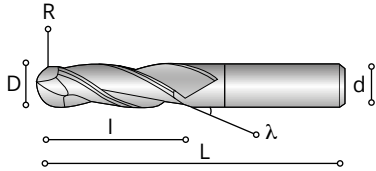

CL17RHM



D h10	R ± 0,02	L	I	d h6	Z	CODE	Micrograin Carbide Co10	CODE	Micrograin Carbide Co10
							1171..... €		2171..... € SAPPHIRE
3	1,5	55	14	3	330009	43,4630008	50,24
4	2	55	16	4	340009	46,3540008	54,15
5	2,5	60	20	5	350009	48,4250008	59,22
6	3	70	20	6	360009	53,1260008	63,78
7	3,5	75	26	7	370009	71,1970008	86,34
8	4	80	32	8	380009	72,4780008	87,85
9	4,5	80	32	9	390009	99,4790008	109,37
10	5	100	36	10	310009	99,4710008	111,39
12	6	100	40	12	312009	135,0312008	147,00
14	7	100	45	14	314009	196,8714008	223,47
16	8	120	52	16	316009	257,9316008	297,43
18	9	120	52	18	318009	312,5418008	372,49
20	10	130	64	20	320009	416,1520008	479,47

CL 21TFHM

DIN
6527LDIN
6528

N

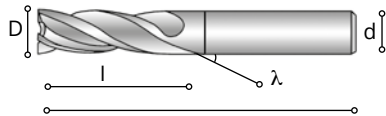
 λ
30°LASER RING I[®]

CL21TFHM



D h10	L	I	d h6	Z	CODE	Micrograin Carbide Co10		Micrograin Carbide Co10
						1213..... €	CODE	2215..... € SAPPHIRE
2	38	7	3	402009	18,6802008	22,90
3	38	8	3	430009	20,0030008	25,03
4	50	11	4	440009	18,6640008	23,43
5	50	13	5	450009	21,6350008	28,27
6	57	13	6	460009	24,8260008	31,91
7	60	16	7	470009	31,4670008	39,99
8	63	19	8	480009	39,1180008	48,39
9	67	19	9	490009	48,4390008	59,96
10	72	22	10	410009	55,1210008	64,52
12	83	26	12	412009	77,8712008	91,04
14	83	26	14	414009	103,1414008	121,50
16	92	32	16	416009	143,3216008	165,86
18	92	32	18	418009	173,7218008	200,42
20	104	38	20	420009	225,8520008	264,25

CL21TFHMB

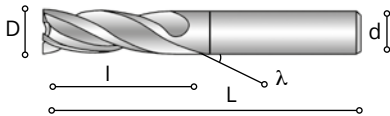

CL21TFHMB



D h10	L	l	d h6	Z	CODE	Micrograin Carbide Co10
						2215..... € SAPPHIRE SLEEK
3,00	50	10	3,00	430008B	17,52
3,50	50	10	3,50	435008B	19,50
4,00	50	11	4,00	440008B	16,40
4,50	50	11	4,50	445008B	23,10
5,00	50	13	5,00	450008B	19,79
5,50	57	13	5,50	455008B	25,71
6,00	57	13	6,00	460008B	22,34
6,50	60	16	6,50	465008B	25,56
7,00	60	16	7,00	470008B	28,00
7,50	63	19	7,50	475008B	31,81
8,00	63	19	8,00	480008B	33,87
8,50	67	19	8,50	485008B	38,40
9,00	67	19	9,00	490008B	41,97
9,50	72	22	9,50	495008B	47,92
10,00	72	22	10,00	410008B	45,16
10,50	72	22	10,50	410508B	52,39
11,00	83	25	11,00	411008B	65,48
12,00	83	25	12,00	412008B	63,73
13,00	83	25	13,00	413008B	82,55
14,00	83	26	14,00	414008B	87,58
15,00	92	32	15,00	415008B	109,18
16,00	92	32	16,00	416008B	122,42
17,00	92	32	17,00	417008B	153,84
18,00	92	32	18,00	418008B	160,95
19,00	92	32	19,00	419008B	198,83
20,00	104	38	20,00	420008B	203,34

CL 21CrHM

DIN
6527LDIN
6528

N

 λ
30°

LASER RING I®

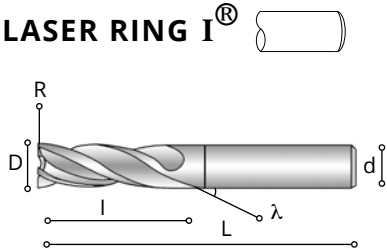

CL21CrHM



D h10	R	L	I	d h6	Z	CODE	Micrograin Carbide Co10	CODE	Micrograin Carbide Co10
							1210..... €		2210..... € SAPPHIRE
2	0,3	38	7	3	402019	21,2202018	25,91
3	0,3	38	8	3	430019	22,7430018	28,33
4	0,5	50	11	4	440019	21,1940018	26,52
5	0,5	50	13	5	450019	24,5550018	31,97
6	0,5	57	13	6	460019	28,1460018	36,06
7	0,8	60	16	7	470019	35,6370018	45,13
8	0,8	63	19	8	480019	44,2480018	54,59
9	0,8	67	19	9	490019	54,7990018	67,65
10	1	72	22	10	410019	62,8310018	76,11
12	1	83	26	12	412019	89,8412018	102,92
14	1	83	26	14	414019	118,9814018	141,54
16	1,5	92	32	16	416019	162,0916018	189,50
18	1,5	92	32	18	418019	200,3118018	233,48
20	2	104	38	20	420019	260,4820018	307,84

Altri raggi a richiesta - We can manufacture on request these cutters with different corner radius size

CL 21RSHM 



LASER RING I[®] 

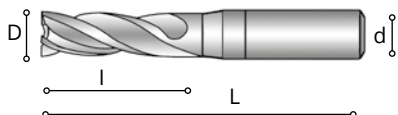

CL21RSHM



D h10	L	I	d h6	Z	CODE	1213..... €	CODE	Micrograin Carbide Co10
								2215..... € SAPPHIRE
2	50	4	6	402029	30,4102028	37,97
2,5	50	4	6	425029	30,4125028	38,54
3	50	5	6	430029	30,4130028	37,97
3,5	50	6	6	435029	30,4135028	38,54
4	54	8	6	440029	30,4140028	37,97
4,5	54	8	6	445029	30,4145028	38,54
5	54	9	6	450029	30,4150028	38,54
5,5	54	10	6	455029	30,4155028	38,54

CL 21RHM

DIN
6527LDIN
6528

N

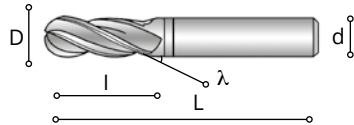
 λ
30°LASER RING I[®] 

CL21RHM



D h10	R ± 0,02	L	I	d h6	Z	CODE	Micrograin Carbide Co10		Micrograin Carbide Co10
							1211..... €	CODE	2211..... € SAPPHIRE
2	1	38	7	3	402009	30,3902008	35,93
3	1,5	38	8	3	430009	25,7430008	30,61
4	2	50	11	4	440009	29,4840008	34,02
5	2,5	50	13	5	450009	34,0350008	40,39
6	3	57	13	6	460009	34,3460008	41,03
7	3,5	60	16	7	470009	50,3870008	58,56
8	4	63	19	8	480009	47,5380008	55,52
9	4,5	67	19	9	490009	74,4590008	89,72
10	5	72	22	10	410009	72,2810008	81,06
12	6	83	26	12	412009	89,5512008	105,94
14	7	83	26	14	414009	125,5414008	146,31
16	8	92	32	16	416009	157,5216008	175,43
18	9	92	32	18	418009	209,7018008	240,42
20	10	104	38	20	420009	265,5420008	291,29

FRESE A QUATTRO TAGLIENTI CON ELICA DIFFERENZIATA E DIVISIONE IRREGOLARE
FOUR FLUTE END MILLS WITH HELIX DIFFERENTIATED IRREGULAR DIVISION

CL 21EDHM



LASER RING I[®] 

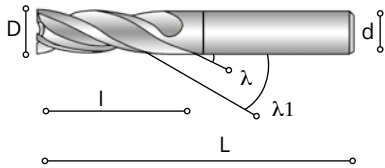

CL21EDHM



D h10	L	I	d h6	Z	CODE	Micrograin Carbide Co10
						2216..... € SAPPHIRE SLEEK
5	50	13	5	450008	38,44
6	57	13	6	460008	41,48
8	63	19	8	480008	54,91
10	72	22	10	410008	70,37
12	83	26	12	412008	96,56
14	83	26	14	414008	146,03
16	92	32	16	416008	171,12
18	92	32	18	418008	212,32
20	104	38	20	420008	274,90

CL 22EDHM

DIN
6527LDIN
6528

N

 λ
38° λ_1
40°

45°

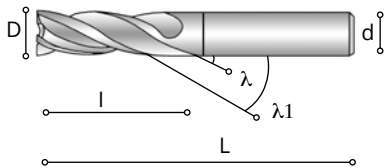
LASER RING I[®] 

CL22EDHM



D h10	L	l	d h6	Z	CODE	Micrograin Carbide Co10
						2226..... € SAPPHIRE SLEEK
5	60	20	5	450008	44,16
6	70	20	6	460008	48,94
8	80	32	8	480008	78,17
10	100	36	10	410008	103,44
12	100	40	12	412008	142,21
14	100	45	14	414008	207,31
16	120	52	16	416008	268,57
18	120	52	18	418008	319,11
20	130	64	20	420008	447,09

CL 22TFHM 



LASER RING I[®] 

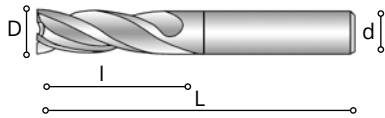

CL22TFHM



D h10	L	l	d h6	Z	CODE	Micrograin Carbide Co10		
						1223..... €	CODE	
						Micrograin Carbide Co10		
						2225..... € SAPPHIRE		
3	55	14	3	430009	24,7630008	31,41
4	55	16	4	440009	26,6940008	33,06
5	60	20	5	450009	28,6650008	36,28
6	70	20	6	460009	33,2660008	41,18
7	75	26	7	470009	47,9170008	58,64
8	80	32	8	480009	56,5280008	69,12
9	80	32	9	490009	64,7490008	79,62
10	100	36	10	410009	80,2010008	93,85
12	100	40	12	412009	118,2712008	125,72
14	100	45	14	414009	184,0314008	188,40
16	120	52	16	416009	205,9816008	248,20
18	120	52	18	418009	261,7718008	298,47
20	130	64	20	420009	396,1920008	420,98

CL 22RHM

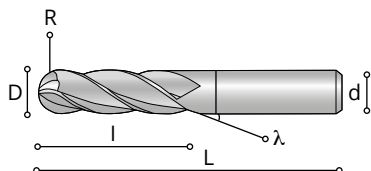
LASER RING I[®]

CL22RHM



D h10	R ± 0,02	L	I	d h6	Z	CODE	Micrograin Carbide Co10		Micrograin Carbide Co10
							1221..... €	CODE	2221..... € SAPPHIRE
3	1,5	55	14	3	430009	43,4630008	50,24
4	2	55	16	4	440009	46,3540008	54,15
5	2,5	60	20	5	450009	48,4250008	59,22
6	3	70	20	6	460009	53,1260008	63,78
7	3,5	75	26	7	470009	71,1970008	86,34
8	4	80	32	8	480009	72,4780008	87,85
9	4,5	80	32	9	490009	99,4790008	109,37
10	5	100	36	10	410009	99,4710008	111,39
12	6	100	40	12	412009	135,0312008	147,00
14	7	100	45	14	414009	196,8714008	223,47
16	8	120	52	16	416009	257,9316008	297,43
18	9	120	52	18	418009	312,5418008	372,49
20	10	130	64	20	420009	416,1520008	479,47

CL 24TFPFHM 



LASER RING I[®] 

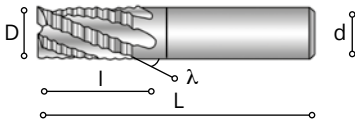

CL24TFPFHM



D h10	L	l	d h6	Z	CODE	Micrograin Carbide Co10	CODE	Micrograin Carbide Co10
						1244..... €		2246..... € SAPPHIRE
6	57	13	6	460009	36,0460008	43,65
8	63	19	8	480009	53,1180008	63,17
10	72	22	10	410009	75,2410008	88,57
12	83	26	12	412009	102,8912008	120,77
14	83	26	14	414009	129,3114008	144,39
16	92	32	16	416009	168,3116008	190,22
18	92	32	18	418009	205,8018008	231,68
20	104	38	20	420009	258,7120008	295,61

FRESE CILINDRICHE FRONTALI PER SEMIFINIRE | SEMIFINISHING END MILLS

CL 25TFHM 



LASER RING I[®] 

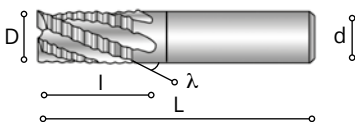

CL25TFHM



D h10	L	l	d h6	Z	CODE	Micrograin Carbide Co10	CODE	Micrograin Carbide Co10
						1253..... €		2255..... € SAPPHIRE
6	57	13	6	460009	37,6960008	45,52
8	63	19	8	480009	55,5280008	65,90
10	72	22	10	410009	78,6410008	92,41
12	83	26	12	412009	107,5612008	126,02
14	83	26	14	414009	135,1914008	150,69
16	92	32	16	416009	175,9516008	198,59
18	92	32	18	418009	215,1418008	241,89
20	104	38	20	420009	270,4620008	308,57

Su richiesta si possono fornire toriche e con testa semisferica - On request we can manufacture also with corner radius or full radius

CS 47HM

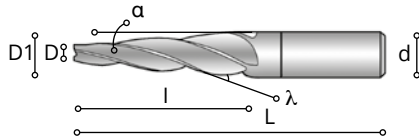
LASER RING I[®]

CS47HM



α	D	D1	L	l	d h6	Z	CODE	Micrograin Carbide Co10	CODE	Micrograin Carbide Co10
								1470..... €		2470..... € SAPPHIRE
1°	4	5,22	80	35	6	410049	67,2410048	79,05
1°	5	6,40	85	40	7	410059	96,1110058	111,77
1°	6	7,57	90	45	8	410069	105,3310068	121,90
1°	8	10,00	100	57	10	410089	129,8010088	150,01
2°	4	6,44	80	35	7	420049	84,2920048	98,76
2°	5	8,00	85	43	8	420059	103,6820058	120,08
2°	6	9,14	90	45	10	420069	117,8420068	136,85
2°	8	12,00	100	57	12	420089	153,4520088	176,02
3°	4	8,00	80	38	8	430049	96,8030048	112,52
3°	5	9,19	85	40	10	430059	107,6630058	125,65
3°	6	10,00	90	38	10	430069	104,0930068	121,72
3°	8	14,00	100	57	14	430089	179,7130088	205,50
4°	4	8,89	80	35	10	440049	104,9140048	122,63
4°	5	10,59	85	40	11	440059	125,4040058	145,17
4°	6	12,00	90	43	12	440069	127,0540068	146,98
4°	8	16,00	100	57	16	440089	204,8840088	233,18
5°	4	10,00	80	34	10	450049	105,6050048	123,39
5°	5	12,00	85	40	12	450059	122,7950058	142,29
5°	6	14,00	90	46	14	450069	169,1350068	193,85

Su richiesta si possono fornire conicità diverse - On request we can manufacture with different angles

ALL 158HM
ALU



LASER RING I[®]

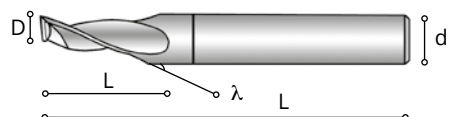

ALL158HM



D	L	I	I1	d h6	Z	CODE	Micrograin Carbide Co10	CODE	Micrograin Carbide Co10
							4158..... €		2158..... € SAPPHIRE
3	50	12	-	3	130009	23,2230008	28,95
4	50	15	-	4	140009	27,2040008	33,33
5	60	17	-	5	150009	32,2750008	40,17
5	60	17	-	8	150089	51,1450088	62,06
6	60	20	-	6	160009	36,6360008	44,97
6	60	20	-	8	160089	54,9660088	66,25
8	70	22	-	8	180009	55,9880008	66,95
8	100	25	50	8	181009	71,6581008	85,65
10	80	25	-	10	110009	83,9610008	100,53
10	100	25	50	10	110109	102,8110108	121,25
12	100	30	45	12	112009	113,3312008	133,08

ALL 161HM
ALU

DIN
6528



LASER RING I[®]

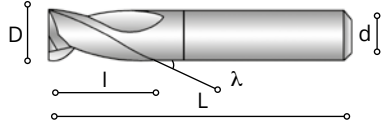

ALL161HM



D h10	L	I	d h6	Z	CODE	Micrograin Carbide Co10		Micrograin Carbide Co10
						4161..... €	CODE	2161..... € SAPPHIRE
3	50	7	3	230009	22,4903008	27,63
4	50	8	4	240009	23,9304008	29,10
5	50	10	5	250009	22,6005008	29,32
6	57	10	6	260009	26,0506008	33,27
7	60	13	7	270009	33,0407008	41,72
8	63	16	8	280009	41,0708008	50,55
9	67	16	9	290009	50,8509008	62,62
10	72	19	10	210009	57,8701008	67,43
12	83	22	12	212009	81,7601208	95,20
14	83	22	14	214009	108,2901408	127,16
16	92	26	16	216009	147,5401608	170,34
18	92	26	18	218009	182,4001808	209,98
20	104	32	20	220009	237,1400208	276,74

Su richiesta si possono fornire toriche e con testa semisferica - On request we can manufacture also with corner radius or full radius

ALL 163HM
ALU



LASER RING I® 

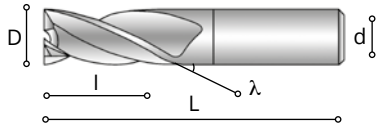

ALL163HM



D h10	L	I	d h6	Z	CODE	1163..... €	CODE	Micrograin Carbide Co10
								2163..... € SAPPHIRE
3	50	7	3	330009	26,1030008	31,46
4	50	8	4	340009	27,8240008	33,30
5	50	10	5	350009	26,2750008	33,39
6	57	10	6	360009	30,3560008	38,02
7	60	13	7	370009	40,1170008	49,54
8	63	16	8	380009	42,7280008	52,38
9	67	16	9	390009	56,6290008	69,00
10	72	19	10	310009	55,1410008	64,54
12	83	22	12	312009	81,7312008	95,18
14	83	22	14	314009	111,4214008	130,63
16	92	26	16	316009	146,9316008	169,68
18	92	26	18	318009	182,1318008	209,69
20	104	32	20	320009	237,2120008	276,83

Su richiesta si possono fornire toriche e con testa emisferica - On request we can manufacture also with corner radius or full radius

CL 19HM



LASER RING II®

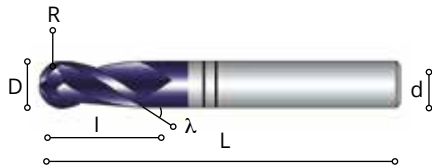

CL19HM



D e8	R ±0,01	L	I	d h6	Z	CODE	Micrograin Carbide Co12
							2190..... € SAPPHIRE
1	0,5	50	2,5	4	201009	67,71
1,5	0,75	50	4	4	201509	67,71
2	1	50	5	6	202009	65,31
3	1,5	60	8	6	203009	65,63
4	2	70	8	6	204009	65,63
5	2,5	80	10	6	205009	66,91
6	3	90	12	6	206009	80,92
8	4	100	14	8	208009	100,02
10	5	100	18	10	210009	115,20
12	6	110	22	12	212009	168,29
16	8	140	30	16	216009	305,53
20	10	160	38	20	220009	427,70

FRESE A DUE TAGLIANTI CON TESTA SEMISFERICA PER MACCHINE A COPIARE | BALL NOSED TWO FLUTE END

CL 19CMHM



LASER RING II®

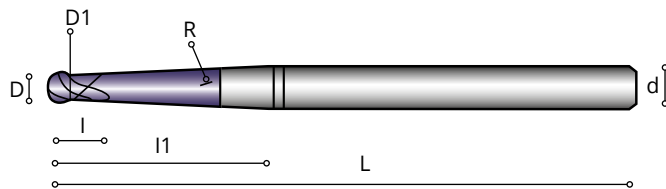

CL19CMHM



D h10	D1	R ±0,01	L	I	I1	D h6	Z	CODE	Micrograin Carbide Co12
									2191..... € SAPPHIRE
3	2,5	1,5	80	4	30	6	203009	76,34
4	3,3	2	80	5	30	6	204009	76,34
5	4,1	2,5	80	6	43	6	205009	76,34
6	4,7	3	100	7	30	6	206009	83,35
8	6,5	4	100	9	36	8	208009	118,10
10	8,2	5	100	11	43	10	210009	190,47
12	9,8	6	100	13	52	12	212009	236,19
16	13,4	8	150	15	61	16	216009	438,34

CL 26HM



LASER RING II[®] 



CL26HM



D e8	L	l	d h6	Z	CODE	Micrograin Carbide Co12
						2260..... € SAPPHIRE
6	57	13	6	660009	42,37
8	63	19	8	680009	59,51
10	72	22	10	610009	95,16
12	83	26	12	612009	127,59
14	83	26	14	614009	160,01
16	92	32	16	616009	213,57
18	92	32	18	618009	261,36
20	104	38	20	820009	350,70

CL 26SLHM



LASER RING II[®] 



CL26SLHM



D e8	L	l	d h6	Z	CODE	Micrograin Carbide Co12
						2262..... € SAPPHIRE
6	80	26	6	660009	53,98
8	85	36	8	680009	78,85
10	95	44	10	610009	117,78
12	105	52	12	612009	157,31
14	105	52	14	614009	203,82
16	130	64	16	616009	289,04
18	130	64	18	618009	355,49
20	150	76	20	820009	423,71

CL 27CrHM

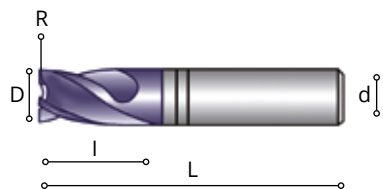
LASER RING II[®]

CL27CrHM



D e8	R	L	I	I1	d1	d h6	Z	CODE	Micrograin Carbide Co12
									2270..... € SAPPHIRE
3	0,3	50	4			3	430019	41,47
4	0,3	50	5			4	440019	45,75
5	0,3	50	6			5	450019	50,90
6	0,8	57	7			6	460019	57,58
8	0,8	63	9			8	480019	74,10
10	1	72	11			10	410019	112,16
12	1	83	12	25	11	12	412019	139,93
16	1,5	92	16	30	15	16	416019	245,97

CL 27CrSLHM



LASER RING II[®]

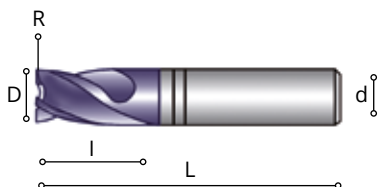

CL27CrSLHM



D e8	R	L	I	I1	d1	d h6	Z	CODE	Micrograin Carbide Co12
									2272..... € SAPPHIRE
3	0,3	80	4			6	430019	65,46
4	0,3	80	5			6	440019	70,26
5	0,3	80	6			6	450019	75,40
6	0,8	80	7	18	5,5	6	460019	73,69
8	0,8	80	9	21	7,5	8	480019	91,68
10	1	100	11	35	9,3	10	410019	141,19
12	1	110	12	35	11	12	412019	174,31
16	1,5	120	16	40	15	16	416019	297,47

Altri raggi a richiesta - We can manufacture on request

CL 400 HM

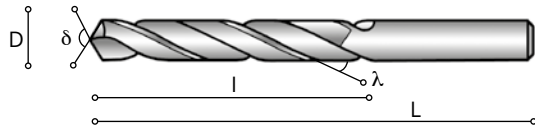
DIN
6539

CL400



D h7	L	l	CODE	Micrograin Carbide Co10	
				5400..... €	7400..... € SAPPHIRE
2	38	1200200	11,36	15,39
2,1	38	1200210	12,75	17,44
2,2	40	1300220	12,75	17,44
2,3	40	1300230	12,75	17,44
2,4	43	1400240	12,75	17,44
2,5	43	1400250	12,75	17,44
2,6	43	1400260	12,75	17,44
2,7	46	1600270	16,91	22,02
2,8	46	1600280	16,91	22,02
2,9	46	1600290	16,91	22,02
3	46	1600300	16,91	22,02
3,1	49	1800310	17,22	22,35
3,2	49	1800320	17,22	22,35
3,3	49	1800330	17,22	22,35
3,4	52	2000340	18,53	23,79
3,5	52	2000350	18,53	23,79
3,6	52	2000360	20,46	25,91
3,7	52	2000370	20,46	25,91
3,8	52	2000380	22,07	27,69
3,9	55	2200390	22,07	27,69
4	55	2200400	22,07	27,69
4,1	55	2200410	23,24	30,23
4,2	55	2200420	23,24	30,23
4,3	58	2400430	24,62	31,75
4,4	58	2400440	24,62	31,75
4,5	58	2400450	24,62	31,75
4,6	58	2400460	24,62	31,75
4,7	58	2400470	26,48	33,79
4,8	62	2600480	26,48	33,79
4,9	62	2600490	26,48	33,79
5	62	2600500	26,48	33,79
5,1	62	2600510	26,48	33,79
5,2	62	2600520	34,49	42,61
5,3	62	2600530	34,49	42,61
5,4	66	2800540	34,49	42,61
5,5	66	2800550	34,49	42,61
5,6	66	2800560	36,67	45,00
5,7	66	2800570	36,67	45,00
5,8	66	2800580	36,67	45,00
5,9	66	2800590	36,67	45,00

D h7	L	I	CODE	Micrograin Carbide Co10	
				5400..... €	7400..... € SAPPHIRE
6	66	2800600	36,67	45,00
6,1	70	3100610	45,83	55,95
6,2	70	3100620	45,83	55,95
6,3	70	3100630	45,83	55,95
6,4	70	3100640	45,83	55,95
6,5	70	3100650	44,52	54,50
6,6	70	3100660	54,11	65,05
6,7	70	3100670	54,11	65,05
6,8	74	3400680	54,11	65,05
6,9	74	3400690	54,11	65,05
7	74	3400700	53,49	64,37
7,5	74	3400750	64,36	76,33
8	79	3700800	72,00	86,24
8,5	79	3700850	90,75	108,24
9	84	4000900	91,68	109,26
9,5	84	4000950	102,01	120,63
10	89	4301000	104,64	123,51
10,2	89	4301020	124,15	144,98
10,5	89	4301050	124,15	144,98
11	95	4701100	137,91	160,11
11,5	95	4701150	161,59	186,15
12	102	5101200	161,59	188,52
13	102	5101300	195,77	227,23

CL 410 HM DIN
338

N

 λ
30° δ
118° A-GRIND

5xD

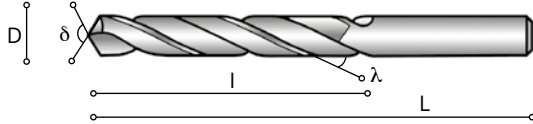

CL410



D h7	L	l	CODE	Micrograin Carbide Co10	
				5410..... €	7410..... € SAPPHIRE
2	49	2400200	14,90	19,29
2,2	53	2700220	19,23	24,57
2,5	57	3000250	18,85	24,15
2,6	57	3000260	25,23	31,18
3	61	3300300	24,40	30,25
3,1	65	3600310	24,40	30,25
3,3	65	3600330	24,62	30,50
3,5	70	3900350	26,80	32,89
4	75	4300400	30,27	36,71
4,2	75	4300420	31,26	39,06
4,5	80	4700450	37,68	47,37
5	86	5200500	41,15	51,19
5,5	93	5700550	54,49	65,86
6	93	5700600	57,73	69,43
6,5	101	6300650	71,47	87,32
6,8	109	6900680	86,51	103,87
7	109	6900700	85,73	103,01
8	117	7500800	102,01	120,92
8,5	117	7500850	118,84	141,50
10	133	8701000	149,72	175,46

CL 415 HM 

CL 425 HM 

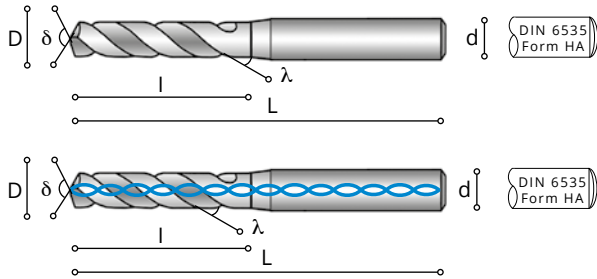

CL415



CL425



D m7	L	l	d h6	CODE	Micrograin Carbide Co10	
					7415..... € SAPPHIRE	7425..... € SAPPHIRE
3	62	20	600300	45,37	73,27
3,1	62	20	600310	45,37	73,27
3,2	62	20	600320	45,37	73,27
3,3	62	20	600330	45,37	73,27
3,4	62	20	600340	45,37	73,27
3,5	62	20	600350	45,37	73,27
3,6	62	20	600360	45,37	73,27
3,7	62	20	600370	45,37	73,27
3,8	66	24	600380	45,37	73,27
3,9	66	24	600390	45,37	73,27
4	66	24	600400	45,37	73,27
4,1	66	24	600410	45,37	73,27
4,2	66	24	600420	45,37	73,27
4,3	66	24	600430	45,37	73,27
4,4	66	24	600440	45,37	73,27
4,5	66	24	600450	45,37	73,27
4,6	66	24	600460	45,37	73,27
4,7	66	24	600470	45,37	73,27
4,8	66	28	600480	45,37	73,27
4,9	66	28	600490	45,37	73,27
5	66	28	600500	45,37	73,27
5,1	66	28	600510	45,37	73,27
5,2	66	28	600520	45,37	73,27
5,3	66	28	600530	45,37	73,27
5,4	66	28	600540	45,37	73,27
5,5	66	28	600550	45,37	73,27
5,6	66	28	600560	45,37	73,27
5,7	66	28	600570	45,37	73,27
5,8	66	28	600580	45,37	73,27
5,9	66	28	600590	45,37	73,27
6	66	28	600600	45,37	73,27
6,1	79	34	800610	70,29	99,53
6,2	79	34	800620	70,29	99,53
6,3	79	34	800630	70,29	99,53
6,4	79	34	800640	70,29	99,53
6,5	79	34	800650	70,29	99,53
6,6	79	34	800660	70,29	99,53
6,7	79	34	800670	70,29	99,53
6,8	79	34	800680	70,29	99,53
6,9	79	34	800690	70,29	99,53

CL 415 HM 

CL 425 HM 

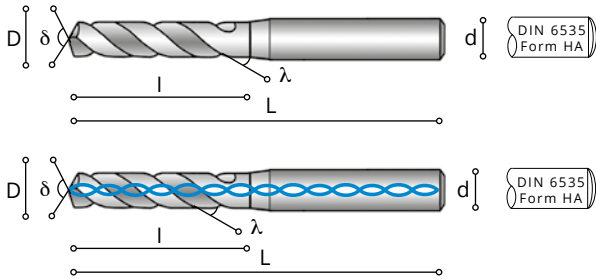

CL415

CL425



D m7	L	l	d h6	CODE	Micrograin Carbide Co10	
					7415..... € SAPPHIRE	7425..... € SAPPHIRE
7	79	34	800700	70,29	99,53
7,1	79	41	800710	70,29	99,53
7,2	79	41	800720	70,29	99,53
7,3	79	41	800730	70,29	99,53
7,4	79	41	800740	70,29	99,53
7,5	79	41	800750	70,29	99,53
7,6	79	41	800760	70,29	99,53
7,7	79	41	800770	70,29	99,53
7,8	79	41	800780	70,29	99,53
7,9	79	41	800790	70,29	99,53
8	79	41	800800	70,29	99,53
8,1	89	47	1000810	89,76	111,51
8,2	89	47	1000820	89,76	111,51
8,3	89	47	1000830	89,76	111,51
8,4	89	47	1000840	89,76	111,51
8,5	89	47	1000850	89,76	111,51
8,6	89	47	1000860	89,76	111,51
8,7	89	47	1000870	89,76	111,51
8,8	89	47	1000880	89,76	111,51
8,9	89	47	1000890	89,76	111,51
9	89	47	1000900	89,76	111,51
9,1	89	47	1000910	89,76	111,51
9,2	89	47	1000920	89,76	111,51
9,3	89	47	1000930	89,76	111,51
9,4	89	47	1000940	89,76	111,51
9,5	89	47	1000950	89,76	111,51
9,6	89	47	1000960	89,76	111,51
9,7	89	47	1000970	89,76	111,51
9,8	89	47	1000980	89,76	111,51
9,9	89	47	1000990	89,76	111,51
10	89	47	1001000	89,76	111,51
10,1	102	55	1201010	112,90	159,64
10,2	102	55	1201020	112,90	159,64
10,3	102	55	1201030	112,90	159,64
10,4	102	55	1201040	112,90	159,64
10,5	102	55	1201050	112,90	159,64
10,6	102	55	1201060	112,90	159,64
10,7	102	55	1201070	112,90	159,64
10,8	102	55	1201080	112,90	159,64
10,9	102	55	1201090	112,90	159,64

D m7	L	l	d h6	CODE	Micrograin Carbide Co10	
					7415..... € SAPPHIRE	7425..... € SAPPHIRE
11	102	55	1201100	112,90	159,64
11,1	102	55	1201110	112,90	159,64
11,2	102	55	1201120	112,90	159,64
11,3	102	55	1201130	112,90	159,64
11,4	102	55	1201140	112,90	159,64
11,5	102	55	1201150	112,90	159,64
11,6	102	55	1201160	112,90	159,64
11,7	102	55	1201170	112,90	159,64
11,8	102	55	1201180	112,90	159,64
11,9	102	55	1201190	112,90	159,64
12	102	55	1201200	112,90	159,64
12,3	107	60	1401230	168,35	
12,5	107	60	1401250	168,35	223,09
12,8	107	60	1401280	168,35	
13	107	60	1401300	168,35	223,09
13,5	107	60	1401350	168,35	223,09
13,8	107	60	1401380	168,35	
14	107	60	1401400	168,35	223,09
14,5	115	65	1601450	206,51	272,28
14,8	115	65	1601480	206,51	
15	115	65	1601500	206,51	272,28
15,5	115	65	1601550	206,51	272,28
15,8	115	65	1601580	206,51	
16	115	65	1601600	206,51	272,28
16,5	123	73	1801650	252,70	437,41
16,8	123	73	1801680	252,70	
17	123	73	1801700	252,70	437,41
17,5	123	73	1801750	252,70	437,41
17,8	123	73	1801780	252,70	
18	123	73	1801800	252,70	437,41
18,5	131	79	2001850	310,43	477,88
19	131	79	2001900	310,43	477,88
19,5	131	79	2001950	310,43	477,88
19,8	131	79	2001980	310,43	
20	131	79	2002000	310,43	477,88

CL 420 HM 

CL 430 HM 

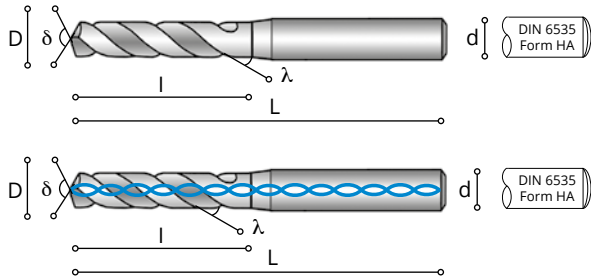

CL420

CL430



D m7	L	l	d h6	CODE	Micrograin Carbide Co10	
					7420..... € SAPPHIRE	7430..... € SAPPHIRE
3	66	28	600300	61,22	94,04
3,1	66	28	600310	61,22	94,04
3,2	66	28	600320	61,22	94,04
3,3	66	28	600330	61,22	94,04
3,4	66	28	600340	61,22	94,04
3,5	66	28	600350	61,22	94,04
3,6	66	28	600360	61,22	94,04
3,7	66	28	600370	61,22	94,04
3,8	74	36	600380	61,22	94,04
3,9	74	36	600390	61,22	94,04
4	74	36	600400	61,22	94,04
4,1	74	36	600410	61,22	94,04
4,2	74	36	600420	61,22	94,04
4,3	74	36	600430	61,22	94,04
4,4	74	36	600440	61,22	94,04
4,5	74	36	600450	61,22	94,04
4,6	74	36	600460	61,22	94,04
4,7	74	36	600470	61,22	94,04
4,8	82	44	600480	61,22	94,04
4,9	82	44	600490	61,22	94,04
5	82	44	600500	61,22	94,04
5,1	82	44	600510	61,22	94,04
5,2	82	44	600520	61,22	94,04
5,3	82	44	600530	61,22	94,04
5,4	82	44	600540	61,22	94,04
5,5	82	44	600550	61,22	94,04
5,6	82	44	600560	61,22	94,04
5,7	82	44	600570	61,22	94,04
5,8	82	44	600580	61,22	94,04
5,9	82	44	600590	61,22	94,04
6	82	44	600600	61,22	94,04
6,1	91	53	800610	75,19	103,91
6,2	91	53	800620	75,19	103,91
6,3	91	53	800630	75,19	103,91
6,4	91	53	800640	75,19	103,91
6,5	91	53	800650	75,19	103,91
6,6	91	53	800660	75,19	103,91
6,7	91	53	800670	75,19	103,91
6,8	91	53	800680	75,19	103,91
6,9	91	53	800690	75,19	103,91

D m7	L	l	d h6	CODE	Micrograin Carbide Co10	
					7420..... € SAPPHIRE	7430..... € SAPPHIRE
7	91	53	800700	75,19	103,91
7,1	91	53	800710	75,19	103,91
7,2	91	53	800720	75,19	103,91
7,3	91	53	800730	75,19	103,91
7,4	91	53	800740	75,19	103,91
7,5	91	53	800750	75,19	103,91
7,6	91	53	800760	75,19	103,91
7,7	91	53	800770	75,19	103,91
7,8	91	53	800780	75,19	103,91
7,9	91	53	800790	75,19	103,91
8	91	53	800800	75,19	103,91
8,1	103	61	1000810	96,84	123,67
8,2	103	61	1000820	96,84	123,68
8,3	103	61	1000830	96,84	123,68
8,4	103	61	1000840	96,84	123,68
8,5	103	61	1000850	96,84	123,68
8,6	103	61	1000860	96,84	123,68
8,7	103	61	1000870	96,84	123,68
8,8	103	61	1000880	96,84	123,68
8,9	103	61	1000890	96,84	123,68
9	103	61	1000900	96,84	123,68
9,1	103	61	1000910	96,84	123,68
9,2	103	61	1000920	96,84	123,68
9,3	103	61	1000930	96,84	123,68
9,4	103	61	1000940	96,84	123,68
9,5	103	61	1000950	96,84	123,68
9,6	103	61	1000960	96,84	123,68
9,7	103	61	1000970	96,84	123,68
9,8	103	61	1000980	96,84	123,68
9,9	103	61	1000990	96,84	123,68
10	103	61	1001000	96,84	123,68
10,1	118	71	1201010	150,57	173,85
10,2	118	71	1201020	150,57	173,85
10,3	118	71	1201030	150,57	173,85
10,4	118	71	1201040	150,57	173,85
10,5	118	71	1201050	150,57	173,85
10,6	118	71	1201060	150,57	173,85
10,7	118	71	1201070	150,57	173,85
10,8	118	71	1201080	150,57	173,85
10,9	118	71	1201090	150,57	173,85
11	118	71	1201100	150,57	173,85
11,1	118	71	1201110	150,57	173,85
11,2	118	71	1201120	150,57	173,85
11,3	118	71	1201130	150,57	173,85
11,4	118	71	1201140	150,57	173,85
11,5	118	71	1201150	150,57	173,85
11,6	118	71	1201160	150,57	173,85
11,7	118	71	1201170	150,57	173,85
11,8	118	71	1201180	150,57	173,85
11,9	118	71	1201190	150,57	173,85
12	118	71	1201200	150,57	173,85
12,3	124	77	1401230	178,41	
12,5	124	77	1401250	178,41	234,03
12,8	124	77	1401280	178,41	
13	124	77	1401300	178,41	234,02
13,5	124	77	1401350	178,41	234,02
13,8	124	77	1401380	178,41	
14	124	77	1401400	178,41	234,02
14,5	133	83	1601450	224,61	309,29
14,8	133	83	1601480	224,61	

CL 420 HM 

CL 430 HM 

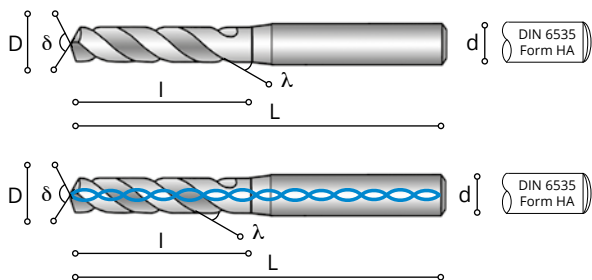

CL420

CL430



D m7	L	l	d h6	CODE	Micrograin Carbide Co10	
					7420..... € SAPPHIRE	7430..... € SAPPHIRE
15	133	83	1601500	224,61	309,29
15,5	133	83	1601550	224,61	309,29
15,8	133	83	1601580	224,61	309,29
16	133	83	1601600	224,61	309,29
16,5	143	93	1801650	284,67	462,57
16,8	143	93	1801680	284,67	462,57
17	143	93	1801700	284,67	462,57
17,5	143	93	1801750	284,67	462,57
17,8	143	93	1801780	284,67	462,57
18	143	93	1801800	284,67	462,57
18,5	153	101	2001850	357,01	529,58
19	153	101	2001900	357,01	529,58
19,5	153	101	2001950	357,01	529,58
19,8	153	101	2001980	357,01	529,58
20	153	101	2002000	357,01	529,58

CL 435 HM 



S-GRIND

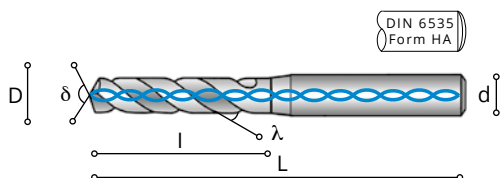

CL435



D m7	L	I	d h6	CODE	Micrograin Carbide Co10
					7435..... € SAPPHIRE
3	72	34	600300	184,03
3,1	72	34	600310	184,03
3,2	72	34	600320	184,03
3,3	72	34	600330	184,03
3,4	72	34	600340	184,03
3,5	72	34	600350	184,03
3,6	72	34	600360	184,03
3,7	72	34	600370	184,03
3,8	81	43	600380	184,03
3,9	81	43	600390	184,03
4	81	43	600400	184,03
4,1	81	43	600410	184,03
4,2	81	43	600420	184,03
4,3	81	43	600430	184,03
4,4	81	43	600440	184,03
4,5	81	43	600450	184,03
4,6	81	43	600460	184,03
4,7	81	43	600470	184,03
4,8	95	57	600480	184,03
4,9	95	57	600490	184,03
5	95	57	600500	184,03
5,1	95	57	600510	184,03
5,2	95	57	600520	184,03
5,3	95	57	600530	184,03
5,4	95	57	600540	184,03
5,5	95	57	600550	184,03
5,6	95	57	600560	184,03
5,7	95	57	600570	184,03
5,8	95	57	600580	184,03
5,9	95	57	600590	184,03
6	95	57	600600	184,03
6,1	114	76	800610	200,28
6,2	114	76	800620	200,28
6,3	114	76	800630	200,28
6,4	114	76	800640	200,28
6,5	114	76	800650	200,28
6,6	114	76	800660	200,28
6,7	114	76	800670	200,28
6,8	114	76	800680	200,28
6,9	114	76	800690	200,28

CL 435 HM



S-GRIND

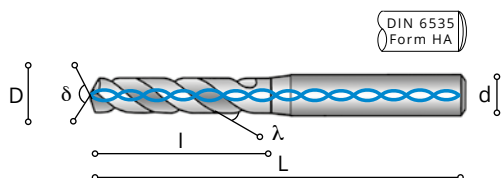

CL435



D m7	L	l	d h6	CODE	Micrograin Carbide Co10
					7435..... € SAPPHIRE
7	114	76	800700	200,28
7,1	114	76	800710	200,28
7,2	114	76	800720	200,28
7,3	114	76	800730	200,28
7,4	114	76	800740	200,28
7,5	114	76	800750	200,28
7,6	114	76	800760	200,28
7,7	114	76	800770	200,28
7,8	114	76	800780	200,28
7,9	114	76	800790	200,28
8	114	76	800800	200,28
8,1	142	95	1000810	271,22
8,2	142	95	1000820	271,22
8,3	142	95	1000830	271,22
8,4	142	95	1000840	271,22
8,5	142	95	1000850	271,22
8,6	142	95	1000860	271,22
8,7	142	95	1000870	271,22
8,8	142	95	1000880	271,22
8,9	142	95	1000890	271,22
9	142	95	1000900	271,22
9,1	142	95	1000910	271,22
9,2	142	95	1000920	271,22
9,3	142	95	1000930	271,22
9,4	142	95	1000940	271,22
9,5	142	95	1000950	271,22
9,6	142	95	1000960	271,22
9,7	142	95	1000970	271,22
9,8	142	95	1000980	271,22
9,9	142	95	1000990	271,22
10	142	95	1001000	271,22
10,1	162	114	1201010	357,58
10,2	162	114	1201020	357,58
10,3	162	114	1201030	357,58
10,4	162	114	1201040	357,58
10,5	162	114	1201050	357,58
10,6	162	114	1201060	357,58
10,7	162	114	1201070	357,58
10,8	162	114	1201080	357,58
10,9	162	114	1201090	357,58

D m7	L	I	d h6	CODE	Micrograin Carbide Co10
					7435..... € SAPPHIRE
11	162	114	1201100	357,58
11,1	162	114	1201110	357,58
11,2	162	114	1201120	357,58
11,3	162	114	1201130	357,58
11,4	162	114	1201140	357,58
11,5	162	114	1201150	357,58
11,6	162	114	1201160	357,58
11,7	162	114	1201170	357,58
11,8	162	114	1201180	357,58
11,9	162	114	1201190	357,58
12	162	114	1201200	357,58

Carmon

APPLICAZIONI CONSIGLIATE



	Taglio Alluminio Aluminium Cut	Taglio singolo Single Cut	Taglio rompitruciolo Chip Breaker	Diamante Diamant Cut	Taglio doppio Double Cut
Applicazioni - Application	LR401	LR402	LR403	LR404	LR406
Alluminio Aluminium	•				
Ottone-Bronzo-Rame Brass-Bronze-Copper			•		•
Fibra di Carbonio Carbon Fiber		•			
Fibra di vetro Fiberglass				•	
Ghisa Cast Iron		•	•		•
Plastica Plastic	•		•	•	•
Acciaio 40-50 HRC 40-50 HRC Steel		•	•	•	•
Acciaio 55-60 HRC 55-60 HRC Steel		•	•	•	•
Acciaio al Carbonio Carbon Steel		•	•		•
Acciaio Nickel Cromo Nickel Chrome Steel		•	•	•	•
Acciaio Inox Stainless Steel		•	•		•
Titanio Titanium		•	•		•
Zinco Zinc	•				

cilindrica 1 taglio cylindrical 1 cut (ZYA)



LR401
LR402
LR403
LR404
LR406

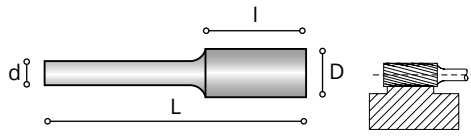

D	d	I	L	Code USA	Code	A401 €	A402 €	A403 €	A404 €	A406 €
3,00	3,00	13	38	SA-43M00313	11,93	9,18	9,18	11,00	9,18
4,00	3,00	13	51	SA-52M00413	29,04	22,34	22,34	26,80	22,34
5,00	6,00	16	61	SA-53M00516	29,04	22,34	22,34	26,80	22,34
6,00	6,00	16	61	SA-1M00616	26,21	20,16	20,16	24,20	20,16
8,00	6,00	20	65	SA-2M00820	30,80	23,69	23,69	28,44	23,69
10,00	6,00	20	65	SA-3M01020	33,83	26,03	26,03	31,23	26,03
12,00	6,00	25	70	SA-5M01225	51,24	39,41	39,41	47,30	39,41
16,00	6,00	25	70	SA-6M01625	76,36	58,74	58,74	70,49	58,74
19,00	6,00	25	70	SA-7M01925	100,44	78,01	78,01	92,70	78,01

cilindrica 2 tagli cylindrical 2 cut (ZYA-S)



LR401
LR402
LR403
LR404
LR406

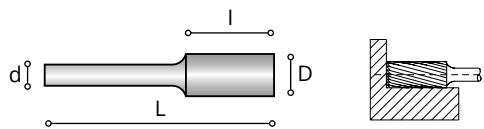

D	d	I	L	Code USA	Code	B401 €	B402 €	B403 €	B404 €	B406 €
3,00	3,00	13	38	SB-43M00313	11,93	9,18	9,18	11,00	9,18
4,00	3,00	13	51	SB-52M00413	29,04	22,34	22,34	26,80	22,34
5,00	6,00	16	61	SB-53M00516	29,04	22,34	22,34	26,80	22,34
6,00	6,00	16	61	SB-1M00616	29,15	22,43	22,43	26,90	22,43
8,00	6,00	20	65	SB-2M00820	33,83	26,03	26,03	31,23	26,03
10,00	6,00	20	65	SB-3M01020	36,98	28,44	28,44	34,13	28,44
12,00	6,00	25	70	SB-5M01225	55,74	42,88	42,88	51,45	42,88
16,00	6,00	25	70	SB-6M01625	82,44	63,41	63,41	76,10	63,41
19,00	6,00	25	70	SB-7M01925	104,54	82,03	82,03	96,49	82,03

cilindrica sferica
cylindrical spherical (WRC)



LR401
LR402
LR403
LR404
LR406

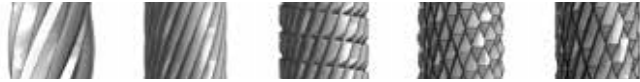
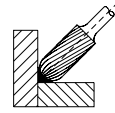
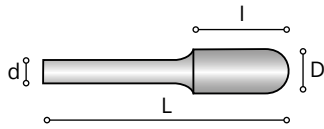

D	d	I	L	Code USA	Code	C401 €	C402 €	C403 €	C404 €	C406 €
3,00	3,00	13	38	SC-43M00313	11,93	9,18	9,18	11,00	9,18
4,00	3,00	13	51	SC-52M00413	29,04	22,34	22,34	26,80	22,34
5,00	3,00	13	51	SC-53M00513	29,04	22,34	22,34	26,80	22,34
6,00	6,00	16	61	SC-1M00616	31,59	24,30	24,30	29,16	24,30
8,00	6,00	20	65	SC-2M00820	34,23	26,33	26,33	31,59	26,33
10,00	6,00	20	65	SC-3M01020	35,60	27,39	27,39	32,86	27,39
12,00	6,00	25	70	SC-5M01225	54,28	41,75	41,75	50,10	41,75
16,00	6,00	25	70	SC-6M01625	76,36	58,74	58,74	70,49	58,74
19,00	6,00	25	70	SC-7M01925	106,63	82,03	82,03	98,41	82,03

A richiesta/On request

cilindrica sferica L 250
cylindrical spherical length 250 mm



D	d	I	L	Code USA	Code	C406 €				
6	6	5,4	250							
8	6	7,2	250							
10	6	9	250							
12	6	11	250							
16	6	14	250							
Altre lunghezze - Other lengths										
6	6	16	80							
6	6	16	100							
6	6	16	70							

sferica
spherical (KUD)



LR401
LR402
LR403
LR404
LR406

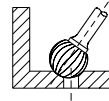
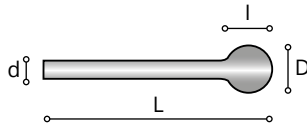

D	d	l	L	Code USA	Code	D401 €	D402 €	D403 €	D404 €	D406 €
3,00	3,00	2,3	38	SD-41M00302		9,18	9,18	11,00	9,18
4,00	3,00	3	41	SD-52M00403		22,34	22,34	26,80	22,34
5,00	3,00	4	43	SD-53M00504		22,34	22,34	26,80	22,34
6,00	6,00	5,4	51	SD-1M00605	31,59	24,30	24,30	29,16	24,30
8,00	6,00	7,2	52	SD-2M00807	31,59	24,30	24,30	29,16	24,30
10,00	6,00	9	54	SD-3M01009	31,78	24,45	24,45	29,34	24,45
12,00	6,00	11	56	SD-5M01211	44,19	33,99	33,99	40,79	33,99
16,00	6,00	14	60	SD-6M01614	60,93	46,86	46,86	56,24	46,86
19,00	6,00	19	62	SD-7M01919	80,38	61,83	61,83	74,19	61,83

A richiesta/On request

sferica L. 250
spherical length 250 mm



D	d	l	L	Code USA	Code	D 406 €				
6	6	5,4	250							
8	6	7,2	250							
10	6	9	250							
12	6	11	250							
16	6	14	250							

ovale
oval (TRE)



LR401
LR402
LR403
LR404
LR406

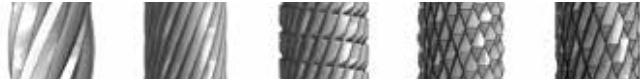
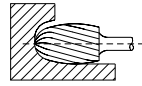
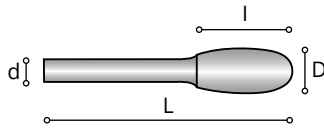

D	d	I	L	Code USA	Code	E401 €	E402 €	E403 €	E404 €	E406 €
3,00	3,00	7	38	SE-41M00307				11,00	9,18
5,00	3,00	8	46	SE-53M00508		22,34	22,34	26,80	22,34
6,00	6,00	10	55	SE-1M00610	31,59	24,30	24,30	29,16	24,30
8,00	6,00	13	58	SE-2M00813	34,23	26,33	26,33	31,59	26,33
10,00	6,00	16	61	SE-3M01016	37,16	28,59	28,59	34,30	28,59
12,00	6,00	20	65	SE-5M01220	52,23	40,18	40,18	48,20	40,18
16,00	6,00	25	70	SE-6M01625	78,41	60,33	60,33	72,39	60,33

ogiva a punta raggiata
tree shape-radius end (RBF)



LR401
LR402
LR403
LR404
LR406

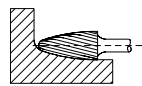
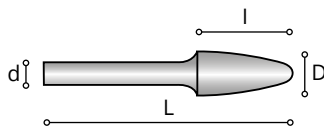

D	d	I	L	Code USA	Code	F401 €	F402 €	F403 €	F404 €	F406 €
3,00	3,00	13	38	SF-41M00313				11,00	9,18
5,00	3,00	13	51	SF-53M00513		22,34	22,34	26,80	22,34
6,00	6,00	18	63	SF-1M00618	31,59	24,30	24,30	29,16	24,30
8,00	6,00	20	65	SF-2M00820	33,25	25,58	25,58	30,69	25,58
10,00	6,00	20	65	SF-3M01020	34,81	26,78	26,78	32,13	26,78
12,00	6,00	25	70	SF-5M01225	49,88	38,36	38,36	46,04	38,36
16,00	6,00	25	70	SF-6M01625	71,39	54,91	54,91	65,89	55,74

ogiva a punta (SPG) tree shape-pointed end



LR401
LR402
LR403
LR404
LR406

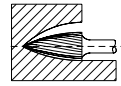
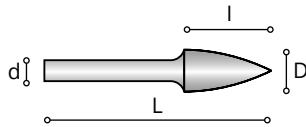

D	d	I	L	Code USA	Code	G401 €	G402 €	G403 €	G404 €	G406 €
3,00	3,00	13	38	SG-44M00313				11,00	9,18
5,00	3,00	13	51	SG-53M00513		22,34	22,34	26,80	22,34
6,00	6,00	18	63	SG-1M00618	31,59	24,30	24,30	29,16	24,30
8,00	6,00	20	65	SG-2M00820	33,64	25,88	25,88	31,05	25,88
10,00	6,00	20	65	SG-3M01020	35,60	27,39	27,39	32,86	27,39
12,00	6,00	25	65	SG-5M01225	50,26	38,66	38,66	46,40	38,66
16,00	6,00	25	70	SG-6M01625	73,53	56,56	56,56	67,88	56,56

fiamma (HM) flame



LR401
LR402
LR403
LR404
LR406

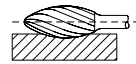
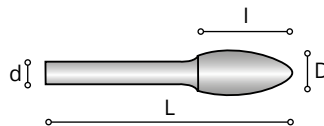

D	d	I	L	Code USA	Code	H401 €	H402 €	H403 €	H404 €	H406 €
3,00	3,00	13	38	SH-41M00313				11,00	9,18
6,00	6,00	18	63	SH-1M00618	53,66	41,29	41,29	49,54	41,29
8,00	6,00	20	65	SH-2M00820	60,93	46,86	46,86	56,24	46,86
10,00	6,00	20	65	SH-3M01020	64,59	49,69	49,69	59,63	49,69
12,00	6,00	32	77	SH-5M01232	71,39	54,91	54,91	65,89	54,91
16,00	6,00	36	81	SH-6M01636	134,75	103,65	103,65	124,39	103,65

conica 60°
60° cone shape (KSJ)



LR401
LR402
LR403
LR404
LR406

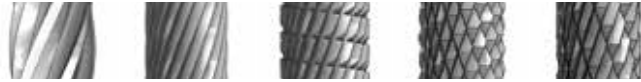
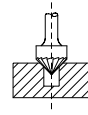
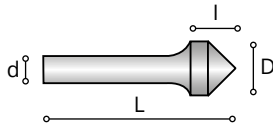

D	d	l	L	Code USA	Code	J401 €	J402 €	J403 €	J404 €	J406 €
3,00	3,00	3	38	SJ-42M00303				11,00	9,18
6,00	6,00	5,2	50	SJ-1M00605		24,30	24,30	29,16	24,30
10,00	6,00	8	53	SJ-3M01008		25,88	25,88	31,05	25,88
12,00	6,00	10	55	SJ-5M01210		35,59	35,59	42,70	35,59
16,00	6,00	14	60	SJ-6M01613		50,71	50,71	60,85	50,71

conica 90°
90° cone shape (KSK)



LR401
LR402
LR403
LR404
LR406

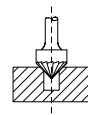
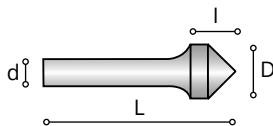

D	d	l	L	Code USA	Code	K401 €	K402 €	K403 €	K404 €	K406 €
3,00	3,00	2	38	SK-42M00302				11,00	9,18
6,00	6,00	3	48	SK-1M00603		24,30	24,30	29,16	24,30
8,00	6,00	4	48	SK-2M00804		24,30	24,30	29,16	24,30
10,00	6,00	5	50	SK-3M01005		24,30	24,30	29,16	24,30
12,00	6,00	6	51	SK-5M01206		33,99	33,99	40,79	33,99
16,00	6,00	8	53	SK-6M01608		46,40	46,40	55,69	46,40

conica con punta raggiata cone shape-radius end (KEL)



LR401
LR402
LR403
LR404
LR406

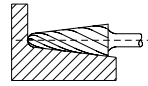
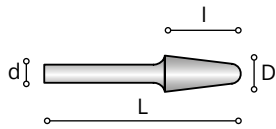

D	d	I	L	Code USA	Code	L401 €	L402 €	L403 €	L404 €	L406 €
3,00	3,00	13	38	SL-42M00313				11,00	9,18
6,00	6,00	16	61	SL-1M00616	31,59	24,30	24,30	29,16	24,30
8,00	6,00	22	67	SL-2M00822	35,60	27,39	27,39	32,86	27,39
10,00	6,00	25	70	SL-3M01025	43,61	33,55	33,55	40,25	33,55
12,00	6,00	28	73	SL-4M01228	54,28	41,75	41,75	50,10	41,75
16,00	6,00	33	78	SL-6M01633	86,60	66,61	66,61	79,94	66,61

conica a punta cone shape (SKM)



LR401
LR402
LR403
LR404
LR406

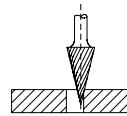
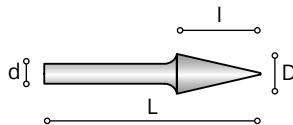

D	d	I	L	Code USA	Code	M401 €	M402 €	M403 €	M404 €	M406 €
3,00	3,00	13	38	SM-42M00313				11,00	9,18
6,00	6,00	18	63	SM-1M00618	33,64	25,88	25,88	31,05	25,88
8,00	6,00	20	63	SM-2M00820	35,20	27,08	27,08	32,50	27,08
10,00	6,00	20	63	SM-4M01020	38,23	29,41	29,41	35,29	29,41
12,00	6,00	25	70	SM-5M01225	54,28	41,75	41,75	50,10	41,75
16,00	6,00	25	70	SM-6M01625	72,36	55,66	55,66	66,79	55,66

conica rovesciata (WKN)
inverted cone shape



LR401
LR402
LR403
LR404
LR406

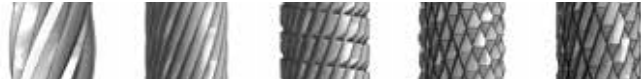
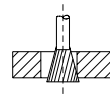
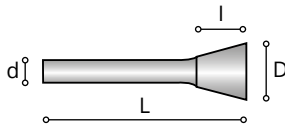





D	d	l	L	Code USA	Code	N401 €	N402 €	N403 €	N404 €	N406 €
3,00	3,00	7	38	SN-42M00307				11,00	9,18
6,00	6,00	7	52	SN-1M00607		24,30	24,30	29,16	24,30
10,00	6,00	10	55	SN-2M01010		27,83	27,83	33,40	27,83
12,00	6,00	13	58	SN-4M01213		37,91	37,91	45,50	37,91
16,00	6,00	15	61	SN-6M01615		52,65	53,70	63,19	53,70







VELOCITÀ CONSIGLIATE RECOMMENDED SPEED





Velocità consigliate Tutte le velocità consigliate nella tabella sotto riportata sono espresse X 1,000 rpm Recommended Speeds All Speeds in the table below quoted X 1,000 rpm	Ø Diametro - Diameter						
	3 mm	6 mm	8 mm	10mm	12 mm	16 mm	19 mm
Alluminio Aluminium	58 - 75	16 - 58	12 - 55	10 - 48	7 - 30	6 - 22	5 - 18
Ottone-Bronzo-Rame Brass-Bronze-Copper	45 - 75	20 - 55	18 - 45	15 - 40	10 - 27	8 - 20	6 - 15
Fibra di Carbonio Carbon Fiber	57 - 75	30 - 48	25 - 40	19 - 28	14 - 21	12 - 17	9 - 14
Fibra di vetro Fiberglass	57 - 75	30 - 48	25 - 40	19 - 28	14 - 21	12 - 17	9 - 14
Ghisa Cast Iron	45 - 75	20 - 55	18 - 45	15 - 40	10 - 27	8 - 20	6 - 15
Plastica Plastic	58 - 75	16 - 58	12 - 55	10 - 48	7 - 30	6 - 22	5 - 18
Acciaio 40-50 HRC 40-50 HRC Steel	57 - 75	30 - 48	25 - 40	19 - 28	14 - 21	12 - 17	9 - 14
Acciaio 55-60 HRC 55-60 HRC Steel	57 - 75	30 - 48	25 - 40	19 - 28	14 - 21	12 - 17	9 - 14
Acciaio al Carbonio Carbon Steel	55 - 75	42 - 58	38 - 50	27 - 38	20 - 28	17 - 19	15 - 17
Acciaio Nikel Cromo Nikel Chrome Steel	57 - 75	30 - 48	25 - 40	19 - 28	14 - 21	12 - 17	9 - 14
Acciaio Inox Stainless Steel	57 - 75	30 - 48	25 - 40	19 - 28	14 - 21	12 - 17	9 - 14
Titanio Titanium	57 - 75	30 - 48	25 - 40	19 - 28	14 - 21	12 - 17	9 - 14
Zinco Zinc	45 - 75	20 - 55	18 - 45	15 - 40	10 - 27	8 - 20	6 - 15

Carmon





















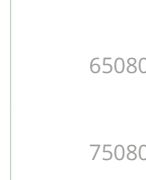





Articolo Article	Tipo Type	Campo d'applicazione Application field	Angolo vertice Point angle	Materiale tipo Tool material	Superficie Surface	Standard	gamma dal (mm) diameter range (mm)	pag page
PUNTE EXTRA LUNGHE TWIST DRILLS EXTRA LONG SERIES								
	KIT CL 104/1 (50 PZ)	N	Acciai comuni Standard steel	118°	HSS	Black	DIN 338 1-5,9 X 0,1	360
	KIT CL 104/2 (41 PZ)	N	Acciai comuni Standard steel	118°	HSS	Black	DIN 338 6-10 X 0,1	360
	KIT CL 104/3 (19 PZ)	N	Acciai comuni Standard steel	118°	HSS	Black	DIN 338 1-10 X 0,5	360
	KIT CL 104/4 (25 PZ)	N	Acciai comuni Standard steel	118°	HSS	Black	DIN 338 1-13 X 0,5	360
	KIT CL 104/5 (49 PZ)	N	Acciai comuni Standard steel	118°	HSS	Black	DIN 338 1-13 X 0,25	360
	KIT CL 104/6 (380 PZ)	N	Acciai comuni Standard steel	118°	HSS	Black	DIN 338 (1-13 X 0,5) - 3,3 - 4,2 - 6,8 - 10,2	360
	KIT CL 104R/1 (50 PZ)	N	Acciai comuni Standard steel	130°	HSS	Quartz	DIN 338 1-5,9 X 0,1	360
	KIT CL 104R/2 (41 PZ)	N	Acciai comuni Standard steel	130°	HSS	Quartz	DIN 338 6-10 X 0,1	360
	KIT CL 104R/3 (19 PZ)	N	Acciai comuni Standard steel	130°	HSS	Quartz	DIN 338 1-10 X 0,5	360
	KIT CL 104R/4 (25 PZ)	N	Acciai comuni Standard steel	130°	HSS	Quartz	DIN 338 1-13 X 0,5	360
	KIT CL 104R/5 (49 PZ)	N	Acciai comuni Standard steel	130°	HSS	Quartz	DIN 338 1-13 X 0,25	360
	KIT CL 106/1 (50 PZ)	W	Acciai tenaci Hardened steel	130°	HSS+5%CO	White	DIN 338 1-5,9 X 0,1	360
	KIT CL 106/2 (41 PZ)	W	Acciai tenaci Hardened steel	130°	HSS+5%CO	White	DIN 338 6-10 X 0,1	360
	KIT CL 106/3 (19 PZ)	W	Acciai tenaci Hardened steel	130°	HSS+5%CO	White	DIN 338 1-10 X 0,5	360
	KIT CL 106/4 (25 PZ)	W	Acciai tenaci Hardened steel	130°	HSS+5%CO	White	DIN 338 1-13 X 0,5	360
	KIT CL 106/5 (49 PZ)	W	Acciai tenaci Hardened steel	130°	HSS+5%CO	White	DIN 338 1-13 X 0,25	360

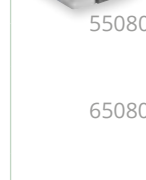

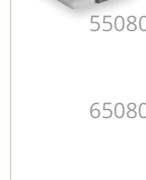

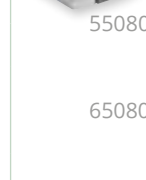















Articolo Article	Tipo Type	Campo d'applicazione Application field	Angolo vertice Point angle	Materiale tipo Tool material	Superficie Surface	Standard	gamma dal (mm) diameter range (mm)	pag page	
	KIT CL 106/6 (380 PZ)	W	Acciai tenaci Hardened steel	130°	HSS+5%CO	White	DIN 338	(1-13 X 0,5)- 3,3-4,2 - 6,8 - 10,2	360
KIT PUNTE PER PREFORI DI MASCHIATURA RANGE OF DRILLS TAPPING SIZE									
	KIT CL 101 (6 PZ)	W	Acciai tenaci Hardened steel	130°	HSS+8%CO	White	DIN 1897	2,5 - 3,3 - 4,2 - 5 - 6,8 - 8,5	361
	KIT CL 101 (6 PZ)	W	Acciai tenaci Hardened steel	130°	HSS+8%CO	Quartz	DIN 1897	2,5 - 3,3 - 4,2 - 5 - 6,8 - 8,5	361
	KIT CL 101 (6 PZ)	W	Acciai tenaci Hardened steel	130°	HSS+8%CO	Titanite	DIN 1897	2,5 - 3,3 - 4,2 - 5 - 6,8 - 8,5	361
	KIT CL 105 (6 PZ)	W	Acciai tenaci Hardened steel	130°	HSS+8%CO	White	DIN 338	2,5 - 3,3 - 4,2 - 5 - 6,8 - 8,5	361
	KIT CL 105 (6 PZ)	W	Acciai tenaci Hardened steel	130°	HSS+8%CO	Quartz	DIN 338	2,5 - 3,3 - 4,2 - 5 - 6,8 - 8,5	361
	KIT CL 105 (6 PZ)	W	Acciai tenaci Hardened steel	130°	HSS+8%CO	Titanite	DIN 338	2,5 - 3,3 - 4,2 - 5 - 6,8 - 8,5	361





















Articolo Article	Tipo Type	Campo d'applicazione Application field	Angolo vertice Point angle	Materiale tipo Tool material	Superficie Surface	Standard	gamma dal (mm) diameter range (mm)	pag page
KIT SVASATORI CONICI RANGE OF COUNTER SINKS								
	KIT SV 74 (3 PZ)	Acciai tenaci Hardened steel		HSS+8%CO	White	DIN 335/C	10,4 -12,4 -16,50	362
	KIT SV 74 (3 PZ)	Acciai tenaci Hardened steel		HSS+8%CO	Sapphire MULTI	DIN 335/C	10,4 -12,4 -16,50	362
	KIT SV 74 (5 PZ)	Acciai tenaci Hardened steel		HSS+8%CO	White	DIN 335/C	10,4 -12,4 -16,5-20,5 -25	362
	KIT SV 74 (5 PZ)	Acciai tenaci Hardened steel		HSS+8%CO	Sapphire MULTI	DIN 335/C	10,4 -12,4 -16,5-20,5 -25	362
	KIT SV 75 Hss (3 PZ)	Acciai tenaci Hardened steel		HSS	White	DIN 335/C	10,4 -12,4 -16,5	363
	KIT SV 75 Hss (3 PZ)	Acciai tenaci Hardened steel		HSS	Quartz	DIN 335/C	10,4 -12,4 -16,5	363
	KIT SV 75 Hss (3 PZ)	Acciai tenaci Hardened steel		HSS	Sapphire	DIN 335/C	10,4 -12,4 -16,5	363
	KIT SV 75 Hss (5 PZ)	Acciai tenaci Hardened steel		HSS	White	DIN 335/C	10,4 -12,4 -16,5-20,5 -25	363
	KIT SV 75 Hss (5 PZ)	Acciai tenaci Hardened steel		HSS	Quartz	DIN 335/C	10,4 -12,4 -16,5-20,5 -25	363
	KIT SV 75 Hss (5 PZ)	Acciai tenaci Hardened steel		HSS	Sapphire	DIN 335/C	10,4 -12,4 -16,5-20,5 -25	363



Articolo Article	Tipo Type	Campo d'applicazione Application field	Angolo vertice Point angle	Materiale tipo Tool material	Superficie Surface	Standard	gamma dal (mm) diameter range (mm)	pag page
KIT SV 75 Hss (6 PZ)		Acciai tenaci Hardened steel		HSS	White	DIN 335/C	6,3-8,3-10,4 -12,4-16,5- 20,5	363
KIT SV 75 Hss (6 PZ)		Acciai tenaci Hardened steel		HSS	Quartz	DIN 335/C	6,3-8,3-10,4 -12,4-16,5- 20,5	363
KIT SV 75 Hss (6 PZ)		Acciai tenaci Hardened steel		HSS	Sapphire	DIN 335/C	6,3-8,3-10,4 -12,4-16,5- 20,5	363
KIT SV 76 HssCo 5% (3 PZ)		Acciai tenaci Hardened steel		HSS+5%CO	White	DIN 335/C	10,4-12,4 -16,5	364
KIT SV 76 HssCo 5% (3 PZ)		Acciai tenaci Hardened steel		HSS+5%CO	Quartz	DIN 335/C	10,4-12,4 -16,5	364
KIT SV 76 HssCo 5% (3 PZ)		Acciai tenaci Hardened steel		HSS+5%CO	Sapphire	DIN 335/C	10,4-12,4 -16,5	364
KIT SV 76 HssCo 5% (5 PZ)		Acciai tenaci Hardened steel		HSS+5%CO	White	DIN 335/C	10,4-12,4 -16,5-20,5 - 25	364
KIT SV 76 HssCo 5% (5 PZ)		Acciai tenaci Hardened steel		HSS+5%CO	Quartz	DIN 335/C	10,4-12,4 -16,5-20,5 - 25	364
KIT SV 76 HssCo 5% (5 PZ)		Acciai tenaci Hardened steel		HSS+5%CO	Sapphire	DIN 335/C	10,4-12,4 -16,5-20,5 - 25	364
KIT SV 76 HssCo 5% (6 PZ)		Acciai tenaci Hardened steel		HSS+5%CO	White	DIN 335/C	6,3-8,3-10,4 -12,4-16,5- 20,5	364
KIT SV 76 HssCo 5% (6 PZ)		Acciai tenaci Hardened steel		HSS+5%CO	Quartz	DIN 335/C	6,3-8,3-10,4 -12,4-16,5- 20,5	364
KIT SV 76 HssCo 5% (6 PZ)		Acciai tenaci Hardened steel		HSS+5%CO	Sapphire	DIN 335/C	6,3-8,3-10,4 -12,4-16,5- 20,5	364

Articolo Article	Imbocco Chamfer	Campo d'applicazione Application field	Angolo elica Point Helix	Materiale tipo Tool material	Superficie Surface	Standard	Gamma dal (M) diameter range (M)	pag page	
KIT MASCHI A MANO HAND TAPS SET									
 AS 500/1 (7 PZ)			0	HSS	White	DIN 352	3-4-5-6-8-10-12	365	
KIT MASCHI A MACCHINA TOLLERANZA 6H CON PUNTE PREFORI MACHINE TAPS SET TOLERANCE 6H WITH PRE HOLES DRILLS									
 553500119		Kit M 535 (7 PZ) Kit CL 119 (7 PZ)	Acciai comuni Standard steel	0	HSS-EX 5%Co	Black White	DIN 371/376 DIN 338	3-4-5-6-8-10-12 2,5-3,3-4,2-5- 6,8-8,5-10,2	365
		Kit M 535 (7 PZ) Kit CL 119 (7 PZ)	Acciai comuni Standard steel	0	HSS-EX 5%Co	Quartz	DIN 371/376 DIN 338	3-4-5-6-8-10-12 2,5-3,3-4,2-5- 6,8-8,5-10,2	365
 553500104R		Kit M 535 (7 PZ) Kit CL 104R (7 PZ)	Acciai comuni Standard steel	0	HSS-EX HSS	Black Quartz	DIN3 71/376 DIN 338	3-4-5-6-8-10-12 2,5-3,3-4,2-5- 6,8-8,5-10,2	365
 551600119		Kit M 516 (7 PZ) Kit CL 119 (7 PZ)	Acciaio inox Stainless steel	0	HSS-EX 5%Co	Black White	DIN 371/376 DIN 338	3-4-5-6-8-10-12 2,5-3,3-4,2-5- 6,8-8,5-10,2	366
		Kit M 516 (7 PZ) Kit CL 119 (7 PZ)	Acciaio inox Stainless steel	0	HSS-EX 5%Co	Quartz	DIN 371/376 DIN 338	3-4-5-6-8-10-12 2,5-3,3-4,2-5- 6,8-8,5-10,2	366
 551600104R		Kit M 516 (7 PZ) Kit CL 104R (7 PZ)	Acciaio inox Stainless steel	0	HSS-EX HSS	Black Quartz	DIN 371/376 DIN 338	3-4-5-6-8-10-12 2,5-3,3-4,2-5- 6,8-8,5-10,2	366
 550800106		Kit M 508 (7 PZ) Kit CL 106 (7 PZ)	Acciai tenaci Hardened steel	0	HSS-EX 5%Co	Black White	DIN 371/376 DIN 338	3-4-5-6-8-10-12 2,5-3,3-4,2-5- 6,8-8,5-10,2	366
		Kit M 508 (7 PZ) Kit CL 106 (7 PZ)	Acciai tenaci Hardened steel	0	HSS-EX 5%Co	Quartz	DIN 371/376 DIN 338	3-4-5-6-8-10-12 2,5-3,3-4,2-5- 6,8-8,5-10,2	366
 750800106		Kit M 508 (7 PZ) Kit CL 106 (7 PZ)	Acciai tenaci Hardened steel	0	HSS-EX 5%Co	Titanite	DIN 371/376 DIN 338	3-4-5-6-8-10-12 2,5-3,3-4,2-5- 6,8-8,5-10,2	366
 550800104R		Kit M 508 (7 PZ) Kit CL 104R(7 PZ)	Acciai tenaci Hardened steel	0	HSS-EX HSS	Black Quartz	DIN 371/376 DIN 338	3-4-5-6-8-10-12 2,5-3,3-4,2-5- 6,8-8,5-10,2	366
		Kit M 508 (7 PZ) Kit CL 104 (7 PZ)	Acciai tenaci Hardened steel	0	HSS-EX HSS	Black	DIN 371/376 DIN 338	3-4-5-6-8-10-12 2,5-3,3-4,2-5- 6,8-8,5-10,2	366
 550800104		Kit M 508 (7 PZ) Kit CL 104 (7 PZ)	Acciai tenaci Hardened steel	0	HSS-EX HSS	Black	DIN 371/376 DIN 338	3-4-5-6-8-10-12 2,5-3,3-4,2-5- 6,8-8,5-10,2	366
 550800101		Kit M 508 (7 PZ) Kit CL 101 (7 PZ)	Acciai tenaci Hardened steel	0	HSS-EX 8%Co	Black White	DIN 371/376 DIN 1897	3-4-5-6-8-10-12 2,5-3,3-4,2-5- 6,8-8,5-10,25	366
		Kit M 508 (7 PZ) Kit CL 101 (7 PZ)	Acciai tenaci Hardened steel	0	HSS-EX 8%Co	Quartz	DIN 371/376 DIN 1897	3-4-5-6-8-10-12 2,5-3,3-4,2-5- 6,8-8,5-10,25	366
 650800101		Kit M 508 (7 PZ) Kit CL 101 (7 PZ)	Acciai tenaci Hardened steel	0	HSS-EX 8%Co	Quartz	DIN 371/376 DIN 1897	3-4-5-6-8-10-12 2,5-3,3-4,2-5- 6,8-8,5-10,25	366
 750800101		Kit M 508 (7 PZ) Kit CL 101 (7 PZ)	Acciai tenaci Hardened steel	0	HSS-EX 8%Co	Titanite	DIN 371/376 DIN 1897	3-4-5-6-8-10-12 2,5-3,3-4,2-5- 6,8-8,5-10,25	366

Articolo Article	Imbocco Chamfer	Campo d'applicazione Application field	Angolo elica Point Helix	Materiale tipo Tool material	Superficie Surface	Standard	Gamma dal (M) diameter range (M)	pag page
KIT MASCHI A MACCHINA TOLLERANZA 6H CON PUNTE PREFORI MACHINE TAPS SET TOLERANCE 6H WITH PRE HOLES DRILLS								
853300106		Acciai tenaci Hardened steel	0	Resistor 5%Co	Opal	DIN 371/376 DIN 338	3-4-5-6-8-10-12 2,5-3,3-4,2-5-6,8-8,5-10,2	367
					Quartz			
553600119		Acciai comuni Standard steel	35	HSS-EX 5%Co	Black	DIN 371/376 DIN 338	3-4-5-6-8-10-12 2,5-3,3-4,2-5-6,8-8,5-10,2	367
					White			
653600119		Acciai comuni Standard steel	35	HSS-EX 5%Co	Quartz	DIN 371/376 DIN 338	3-4-5-6-8-10-12 2,5-3,3-4,2-5-6,8-8,5-10,2	367
553600104R		Acciai comuni Standard steel	35	HSS-EX HSS	Black	DIN 371/376 DIN 338	3-4-5-6-8-10-12 2,5-3,3-4,2-5-6,8-8,5-10,2	367
					Quartz			
551700119		Acciaio inox Stainless steel	35	HSS-EX 5%Co	Black	DIN 371/376 DIN 338	3-4-5-6-8-10-12 2,5-3,3-4,2-5-6,8-8,5-10,2	368
					White			
651700119		Acciaio inox Stainless steel	35	HSS-EX 5%Co	Quartz	DIN 371/376 DIN 338	3-4-5-6-8-10-12 2,5-3,3-4,2-5-6,8-8,5-10,2	368
551700104R		Acciaio inox Stainless steel	35	HSS-EX HSS	Black	DIN 371/376 DIN 338	3-4-5-6-8-10-12 2,5-3,3-4,2-5-6,8-8,5-10,2	368
					Quartz			
551700106		Acciaio inox Stainless steel	35	HSS-EX 5%Co	Black	DIN 371/376 DIN 338	3-4-5-6-8-10-12 2,5-3,3-4,2-5-6,8-8,5-10,2	368
					White			
651700106		Acciaio inox Stainless steel	35	HSS-EX 5%Co	Quartz	DIN 371/376 DIN 338	3-4-5-6-8-10-12 2,5-3,3-4,2-5-6,8-8,5-10,2	368
551200106		Acciai tenaci Hardened steel	35	HSS-EX 5%Co	Black	DIN 371/376 DIN 338	3-4-5-6-8-10-12 2,5-3,3-4,2-5-6,8-8,5-10,2	368
					White			
651200106		Acciai tenaci Hardened steel	35	HSS-EX 5%Co	Quartz	DIN 371/376 DIN 338	3-4-5-6-8-10-12 2,5-3,3-4,2-5-6,8-8,5-10,2	368
751200106		Acciai tenaci Hardened steel	35	HSS-EX 5%Co	Titanite	DIN 371/376 DIN 338	3-4-5-6-8-10-12 2,5-3,3-4,2-5-6,8-8,5-10,2	368
551200104R		Acciai tenaci Hardened steel	35	HSS-EX HSS	Black	DIN 371/376 DIN 338	3-4-5-6-8-10-12 2,5-3,3-4,2-5-6,8-8,5-10,2	368
					Quartz			
551200104		Acciai tenaci Hardened steel	35	HSS-EX HSS	Black	DIN 371/376 DIN 338	3-4-5-6-8-10-12 2,5-3,3-4,2-5-6,8-8,5-10,2	368
551200101		Acciai tenaci Hardened steel	35	HSS-EX 8%Co	Black	DIN 371/376 DIN 1897	3-4-5-6-8-10-12 2,5-3,3-4,2-5-6,8-8,5-10,25	368
					White			
651200101		Acciai tenaci Hardened steel	35	HSS-EX 8%Co	Quartz	DIN 371/376 DIN 1897	3-4-5-6-8-10-12 2,5-3,3-4,2-5-6,8-8,5-10,25	368
751200101		Acciai tenaci Hardened steel	35	HSS-EX 8%Co	Titanite	DIN 371/376 DIN 1897	3-4-5-6-8-10-12 2,5-3,3-4,2-5-6,8-8,5-10,25	368
853400106		Acciai tenaci Hardened steel	45	Resistor 5%Co	Opal	DIN 371/376 DIN 338	3-4-5-6-8-10-12 2,5-3,3-4,2-5-6,8-8,5-10,2	369
					Quartz			



Articolo Article	Imbocco Chamfer	Campo d'applicazione Application field	Angolo elica Point Helix	Materiale tipo Tool material	Superficie Surface	Standard	Gamma dal (M) diameter range (M)	pag page	
KIT MASCHI A MACCHINA MACHINE TAPS SET									
	KIT M 508 (6 PZ)		Acciai tenaci Hardened steel	0	HSS - EX	White	DIN 371	3-4-5-6-8-10	369
	KIT M 508 (6 PZ)		Acciai tenaci Hardened steel	0	HSS - EX	Quartz	DIN 371	3-4-5-6-8-10	369
	KIT M 508 (6 PZ)		Acciai tenaci Hardened steel	0	HSS - EX	Titanite	DIN 371	3-4-5-6-8-10	369
	KIT M 509 (6 PZ)		Acciai tenaci Hardened steel	0	HSS - EX	White	DIN 371	3-4-5-6-8-10	370
	KIT M 509 (6 PZ)		Acciai tenaci Hardened steel	0	HSS - EX	Quartz	DIN 371	3-4-5-6-8-10	370
	KIT M 509 (6 PZ)		Acciai tenaci Hardened steel	0	HSS - EX	Titanite	DIN 371	3-4-5-6-8-10	370
	KIT M 513 (6 PZ)		Alluminio Aluminium	0	HSS - EX	White	DIN 371	3-4-5-6-8-10	370
	KIT M 513 (6 PZ)		Alluminio Aluminium	0	HSS - EX	Quartz	DIN 371	3-4-5-6-8-10	370
	KIT M 513 (6 PZ)		Alluminio Aluminium	0	HSS - EX	Titanite	DIN 371	3-4-5-6-8-10	370
	KIT M 516 (6 PZ)		Acciaio inox Stainless steel	0	HSS - EX	White	DIN 371	3-4-5-6-8-10	370
	KIT M 516 (6 PZ)		Acciaio inox Stainless steel	0	HSS - EX	Quartz	DIN 371	3-4-5-6-8-10	370
	KIT M 517 (6 PZ)		Acciaio inox Stainless steel	35	HSS - EX	White	DIN 371	3-4-5-6-8-10	371
	KIT M 517 (6 PZ)		Acciaio inox Stainless steel	35	HSS - EX	Quartz	DIN 371	3-4-5-6-8-10	371
	KIT M 535		Acciai teneri Soft steel	0	HSS - EX	White	DIN 371	3-4-5-6-8-10	371
	KIT M 535		Acciai teneri Soft steel	0	HSS - EX	Quartz	DIN 371	3-4-5-6-8-10	371
	KIT M 536		Acciai teneri Soft steel	35	HSS - EX	White	DIN 371	3-4-5-6-8-10	371
	KIT M 536		Acciai teneri Soft steel	35	HSS - EX	Quartz	DIN 371	3-4-5-6-8-10	371

Articolo Article	Imbocco Chamfer	Campo d'applicazione Application field	Angolo elica Point Helix	Materiale tipo Tool material	Superficie Surface	Standard	Gamma dal (M) diameter range (M)	pag page	
KIT MASCHI A MACCHINA MACHINE TAPS SET									
	KIT M 511 (6 PZ)		Acciai tenaci Hardened steel	15	HSS - EX	White	DIN 371	3-4-5-6-8-10	372
	KIT M 511 (6 PZ)		Acciai tenaci Hardened steel	15	HSS - EX	Quartz	DIN 371	3-4-5-6-8-10	372
	KIT M 511 (6 PZ)		Acciai tenaci Hardened steel	15	HSS - EX	Titanite	DIN 371	3-4-5-6-8-10	372
	KIT M 512 (6 PZ)		Acciai tenaci Hardened steel	35	HSS - EX	White	DIN 371	3-4-5-6-8-10	372
	KIT M 512 (6 PZ)		Acciai tenaci Hardened steel	35	HSS - EX	Quartz	DIN 371	3-4-5-6-8-10	372
	KIT M 512 (6 PZ)		Acciai tenaci Hardened steel	35	HSS - EX	Titanite	DIN 371	3-4-5-6-8-10	372
	KIT R 570 (6 PZ)		Acciai tenaci Hardened steel	0	HSS - EX	White	DIN 371	3-4-5-6-8-10	372
	KIT R 571 (6 PZ)		Acciai tenaci Hardened steel	0	HSS - EX	White	DIN 371	3-4-5-6-8-10	373
	KIT R 572 (6 PZ)		Acciai tenaci Hardened steel	0	HSS - EX	White	DIN 371	3-4-5-6-8-10	373
	KIT M 524 (6 PZ)		Ghisa Cast iron	0	HSS - EX	Opal	DIN 371	3-4-5-6-8-10	373

Articolo Article	Tipo Type	Campo d'applicazione Application field	Angolo al vertice Point angle	Materiale tipo Tool material	Superficie Surface	Standard	Gamma dal (M) diameter range (M)	pag page
KIT DI FRESE POWDER STEEL END MILL SETS PULVERSTAHLFRAESER-SAETZE								
 CL 11 (6 PZ) resistor	N	Acciai comuni Standard steel Acciai tenaci hardened steel	30	RESISTOR	Sapphire MULTI	DIN 327 D	6-8-10-12-16-20	374
 CL 21 TF (6 PZ) resistor	N	Acciai comuni Standard steel Acciai tenaci hardened steel	30	RESISTOR	Sapphire MULTI	DIN 844 B	6-8-10-12-16-20	374
 CL 24 TF (6 PZ) resistor	NR	Acciai comuni Standard steel Acciai tenaci hardened steel	30	RESISTOR	Sapphire MULTI	DIN 844 B	6-8-10-12-16-20	374
 CL 24 TF PF (6 PZ) resistor	HR	Acciai comuni Standard steel Acciai tenaci hardened steel	30	RESISTOR	Sapphire MULTI	DIN 844 B	6-8-10-12-16-20	374

Articolo Article	Tipo Type	Campo d'applicazione Application field	Angolo elica Point elix	Materiale tipo Tool material	Superficie Surface	Standard	Gamma dal (M) diameter range (M)	pag page
KIT FRESE METALLO DURO SOLID CARBIDE END MILLS SETS								
 CL 11 HM (5 PZ)	N		30	MICROGRAIN CARBIDE Co10	Sapphire	DIN 6527 L / DIN 6528	6-8-10-12-16	375
 CL 16 HM (5 PZ)	N		30	MICROGRAIN CARBIDE Co10	Sapphire	DIN 6527 L / DIN 6528	6-8-10-12-16	375
 CL 18 HM (5 PZ)	N		30	MICROGRAIN CARBIDE Co10	Sapphire	DIN 6527 L / DIN 6528	6-8-10-12-16	375
 CL 21 TF HM (5 PZ)	N		30	MICROGRAIN CARBIDE Co10	Sapphire	DIN 6527 L / DIN 6528	6-8-10-12-16	376
 CL 21 ED HM (5 PZ)	N		38/40	MICROGRAIN CARBIDE Co10	Sapphire	DIN 6527 L / DIN 6528	6-8-10-12-16	376
 CL 19 HM (5 PZ)	HSC		30	MICROGRAIN CARBIDE Co12	Sapphire	CARMON NORM	6-8-10-12-16	376
 CL 26 HM (5 PZ)	HSC		30	MICROGRAIN CARBIDE Co12	Sapphire	DIN 6528	6-8-10-12-16	376

**LIME ROTATIVE IN METALLO DURO
TUNGSTEN CARBIDE ROTARY BURRS**

	set di lime rotative set of rotary burrs	F1225 / F1020 / D1210 / D1009 / C0616 / C1020 / B1020 / B1225	377
	set di lime rotative mm 3 codolo 3 set of rotary burrs mm 3 cod 3	formes A / C / D / E / F / G / H / J / M / N	377

CL 104



25°-30°



STANDARD



CL 104R



25°-30°



DIN 1412 C



N. PEZZI PIECES	Ø	CODE	HSS 5104..... €	HSS 6104..... € QUARTZ
50	1 - 5,9 x 0,110000	114,74	178,61
41	6 - 10 x 0,120000	257,10	411,44
19	1 - 10 x 0,530000	80,36	132,16
25	1 - 13 x 0,540000	167,59	283,89
49	1 - 13 x 0,2550000	380,91	571,37
380	1 - 13 x 0,5 +3,3+4,2+6,8+10,260000	1699,09	2433,95



N. PEZZI PIECES																	
5	10,5	11	11,5	12	12,5	13											
10	1,5	2,5	3,3	3,5	4,2	4,5	5,5	6,5	6,8	7	7,5	8	8,5	9	9,5	10	10,2
20	1	5	6														
30	2																
40	4																
50	3																

CL 106



35°-40°



DIN 1412 C



N. PEZZI PIECES	Ø	CODE	HSS+5%Co 5106..... €
50	1 - 5,9 x 0,110000	181,08
41	6 - 10 x 0,120000	417,79
19	1 - 10 x 0,530000	145,00
25	1 - 13 x 0,540000	301,37
49	1 - 13 x 0,2550000	602,63
380	1 - 13 x 0,5 +3,3+4,2+6,8+10,260000	2549,85



N. PEZZI PIECES																	
5	10,5	11	11,5	12	12,5	13											
10	1,5	2,5	3,3	3,5	4,2	4,5	5,5	6,5	6,8	7	7,5	8	8,5	9	9,5	10	10,2
20	1	5	6														
30	2																
40	4																
50	3																

CL 101



Ø	CODE	HSS+8%Co €
2,5-3,3-4,2-5-6,8-8,5	510110000	32,60

Ø	CODE	HSS+8%Co € QUARTZ
2,5-3,3-4,2-5-6,8-8,5	610110000	56,79

Ø	CODE	HSS+8%Co € TITANITE
2,5-3,3-4,2-5-6,8-8,5	710110000	72,22

CL 105

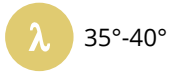

Ø	CODE	HSS+8%Co €
2,5-3,3-4,2-5-6,8-8,5	510510000	41,64

Ø	CODE	HSS+8%Co € QUARTZ
2,5-3,3-4,2-5-6,8-8,5	610510000	69,02

Ø	CODE	HSS+8%Co € TITANITE
2,5-3,3-4,2-5-6,8-8,5	710510000	87,58

SV 74



PEZZI PIECES	Ø	CODE	HSS+8%Co 1740..... €
3	10,4-12,4 16,510000	106,84

PEZZI PIECES	Ø	CODE	HSS+8%Co 2740..... € SAPPHIRE MULTI
3	10,4-12,4 16,510000	138,25

SV 74



PEZZI PIECES	Ø	CODE	HSS+8%Co 1740..... €
5	10,4-12,4-16,5- 20,5-2520000	232,53

PEZZI PIECES	Ø	CODE	HSS+8%Co 2740..... € SAPPHIRE MULTI
5	10,4-12,4-16,5- 20,5-2520000	302,12

SV 75 Hss 



PEZZI PIECES	Ø	CODE	HSS 1750..... €	CODE	HSS 6750..... € QUARTZ	CODE	HSS 2750..... € SAPPHIRE
3	10,4-12,4-16,510000	49,8610000	70,4310000	79,76



PEZZI PIECES	Ø	CODE	HSS 1750..... €	CODE	HSS 6750..... € QUARTZ	CODE	HSS 2750..... € SAPPHIRE
5	10,4-12,4-16,5-20,5-2520000	108,1320000	152,6920000	172,18



PEZZI PIECES	Ø	CODE	HSS 1750..... €	CODE	HSS 6750..... € QUARTZ	CODE	HSS 2750..... € SAPPHIRE
6	6,3-8,3-10,4-12,4-16,5-20,530000	97,0130000	139,6730000	158,24

SV 76 HssCo 5% 

PEZZI PIECES	Ø	CODE	HSS+5%Co 1760..... €	CODE	HSS+5%Co 6760..... € QUARTZ	CODE	HSS+5%Co 2760..... € SAPPHIRE
3	10,4-12,4-16,510000	68,9910000	99,0710000	110,91



PEZZI PIECES	Ø	CODE	HSS+5%Co 1760..... €	CODE	HSS+5%Co 6760..... € QUARTZ	CODE	HSS+5%Co 2760..... € SAPPHIRE
5	10,4-12,4-16,5-20,5-2520000	155,5020000	212,4720000	238,67



PEZZI PIECES	Ø	CODE	HSS+5%Co 1760..... €	CODE	HSS+5%Co 6760..... € QUARTZ	CODE	HSS+5%Co 2760..... € SAPPHIRE
6	6,3-8,3-10,4-12,4-16,5-20,530000	134,2030000	190,3630000	213,54

AS 500/1

DIN 352

λ 0°



60°

6H



M ISO/DIN 13

N. PEZZI PIECES	M	CODE	HSS 5500..... €
7	3 - 4 - 5 - 6 8 - 10 - 1210000	262,94

KIT MASCHI A MACCHINA CON PUNTE PREFORI | MACHINE TAPS SET WITH PRE HOLES DRILLS

M 535
CL 119/CL 104R

DIN 371

DIN 376

DIN 338

λ 0°



60°

6H



N. PEZZI PIECES		CODE	€
14	M 3 - 4 - 5 - 6 - 8 - 10 - 12 D 2,5 - 3,3 - 4,2 - 5 - 6,8 - 8,5 - 10,2	553500119	210,07
14	M 3 - 4 - 5 - 6 - 8 - 10 - 12 D 2,5 - 3,3 - 4,2 - 5 - 6,8 - 8,5 - 10,2	653500119	286,98
14	M 3 - 4 - 5 - 6 - 8 - 10 - 12 D 2,5 - 3,3 - 4,2 - 5 - 6,8 - 8,5 - 10,2	553500104R	191,99

M 516
CL 119/CL104R

DIN
371

DIN
376

DIN
338

λ
0°



60°

6H



N. PEZZI PIECES		CODE	€
14	M 3 - 4 - 5 - 6 - 8 - 10 - 12 D 2,5 - 3,3 - 4,2 - 5 - 6,8 - 8,5 - 10,2	551600119	246,17
14	M 3 - 4 - 5 - 6 - 8 - 10 - 12 D 2,5 - 3,3 - 4,2 - 5 - 6,8 - 8,5 - 10,2	651600119	328,38
14	M 3 - 4 - 5 - 6 - 8 - 10 - 12 D 2,5 - 3,3 - 4,2 - 5 - 6,8 - 8,5 - 10,2	551600104R	228,09

M 508
CL 106/CL 104R/CL 104/CL 101

λ
0°



60°

6H

DIN
371

DIN
376

DIN
338

DIN
1897



N. PEZZI PIECES		CODE	€
14	M 3 - 4 - 5 - 6 - 8 - 10 - 12 D 2,5 - 3,3 - 4,2 - 5 - 6,8 - 8,5 - 10,2	550800106	196,90
14	M 3 - 4 - 5 - 6 - 8 - 10 - 12 D 2,5 - 3,3 - 4,2 - 5 - 6,8 - 8,5 - 10,2	650800106	266,79
14	M 3 - 4 - 5 - 6 - 8 - 10 - 12 D 2,5 - 3,3 - 4,2 - 5 - 6,8 - 8,5 - 10,2	750800106	308,06
14	M 3 - 4 - 5 - 6 - 8 - 10 - 12 D 2,5 - 3,3 - 4,2 - 5 - 6,8 - 8,5 - 10,2	550800104R	191,13
14	M 3 - 4 - 5 - 6 - 8 - 10 - 12 D 2,5 - 3,3 - 4,2 - 5 - 6,8 - 8,5 - 10,2	550800104	175,97
14	M 3 - 4 - 5 - 6 - 8 - 10 - 12 D 2,5 - 3,3 - 4,2 - 5 - 6,8 - 8,5 - 10,25	550800101	201,79
14	M 3 - 4 - 5 - 6 - 8 - 10 - 12 D 2,5 - 3,3 - 4,2 - 5 - 6,8 - 8,5 - 10,25	650800101	267,23
14	M 3 - 4 - 5 - 6 - 8 - 10 - 12 D 2,5 - 3,3 - 4,2 - 5 - 6,8 - 8,5 - 10,25	750800101	304,68

M 533
CL 106



B

N. PEZZI PIECES		CODE	€
14	M 3 - 4 - 5 - 6 - 8 - 10 - 12 D 2,5 - 3,3 - 4,2 - 5 - 6,8 - 8,5 - 10,2	853300106	324,43

M 536
CI 119/CL 104R



C

N. PEZZI PIECES		CODE	€
14	M 3 - 4 - 5 - 6 - 8 - 10 - 12 D 2,5 - 3,3 - 4,2 - 5 - 6,8 - 8,5 - 10,2	553600119	221,87
14	M 3 - 4 - 5 - 6 - 8 - 10 - 12 D 2,5 - 3,3 - 4,2 - 5 - 6,8 - 8,5 - 10,2	653600119	301,59
14	M 3 - 4 - 5 - 6 - 8 - 10 - 12 D 2,5 - 3,3 - 4,2 - 5 - 6,8 - 8,5 - 10,2	553600104R	203,78

M 517 CL 119/CL 104R/CL 106



N. PEZZI PIECES		CODE	€
14	M 3 - 4 - 5 - 6 - 8 - 10 - 12 D 2,5 - 3,3 - 4,2 - 5 - 6,8 - 8,5 - 10,2	551700119	280,89
14	M 3 - 4 - 5 - 6 - 8 - 10 - 12 D 2,5 - 3,3 - 4,2 - 5 - 6,8 - 8,5 - 10,2	651700119	366,51
14	M 3 - 4 - 5 - 6 - 8 - 10 - 12 D 2,5 - 3,3 - 4,2 - 5 - 6,8 - 8,5 - 10,2	551700104R	262,79
14	M 3 - 4 - 5 - 6 - 8 - 10 - 12 D 2,5 - 3,3 - 4,2 - 5 - 6,8 - 8,5 - 10,2	551700106	268,58
14	M 3 - 4 - 5 - 6 - 8 - 10 - 12 D 2,5 - 3,3 - 4,2 - 5 - 6,8 - 8,5 - 10,2	651700106	346,33

M 512 CL 106/CL 104R/CL 104/CL 101

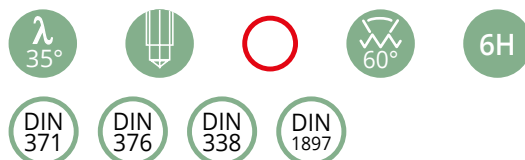

N. PEZZI PIECES		CODE	€
14	M 3 - 4 - 5 - 6 - 8 - 10 - 12 D 2,5 - 3,3 - 4,2 - 5 - 6,8 - 8,5 - 10,2	551200106	209,56
14	M 3 - 4 - 5 - 6 - 8 - 10 - 12 D 2,5 - 3,3 - 4,2 - 5 - 6,8 - 8,5 - 10,2	651200106	281,40
14	M 3 - 4 - 5 - 6 - 8 - 10 - 12 D 2,5 - 3,3 - 4,2 - 5 - 6,8 - 8,5 - 10,2	751200106	321,93
14	M 3 - 4 - 5 - 6 - 8 - 10 - 12 D 2,5 - 3,3 - 4,2 - 5 - 6,8 - 8,5 - 10,2	551200104R	203,79
14	M 3 - 4 - 5 - 6 - 8 - 10 - 12 D 2,5 - 3,3 - 4,2 - 5 - 6,8 - 8,5 - 10,2	551200104	188,63
14	M 3 - 4 - 5 - 6 - 8 - 10 - 12 D 2,5 - 3,3 - 4,2 - 5 - 6,8 - 8,5 - 10,25	551200101	214,45
14	M 3 - 4 - 5 - 6 - 8 - 10 - 12 D 2,5 - 3,3 - 4,2 - 5 - 6,8 - 8,5 - 10,25	651200101	281,84
14	M 3 - 4 - 5 - 6 - 8 - 10 - 12 D 2,5 - 3,3 - 4,2 - 5 - 6,8 - 8,5 - 10,25	751200101	318,56

M 534
CL 106



N. PEZZI PIECES		CODE	€
14	M 3 - 4 - 5 - 6 - 8 - 10 - 12 D 2,5 - 3,3 - 4,2 - 5 - 6,8 - 8,5 - 10,2	853400106	347,01

KIT DI MASCHI A MACCHINA | MACHINE TAPS SETS

KIT
M 508



N. PEZZI PIECES	M	CODE	€	CODE	€ QUARTZ	CODE	€ TITANITE
6	3 - 4 - 5 - 6 8 - 10	550810000	109,62	650810000	141,06	750810000	154,24

KIT M 509

DIN 371

λ 0°



60°

6H



M ISO/DIN 13



N. PEZZI PIECES	M	CODE	€	CODE	€ QUARTZ	CODE	€ TITANITE
6	3 - 4 - 5 - 6 8 - 10	550910000	96,79	650910000	126,94	750910000	140,98

KIT M 513 ALU

DIN 371

λ 0°



60°

6H



M ISO/DIN 13



N. PEZZI PIECES	M	CODE	€	CODE	€ QUARTZ	CODE	€ TITANITE
6	3 - 4 - 5 - 6 8 - 10	551310000	136,63	651310000	168,95	751310000	183,80

KIT M 516 INOX

DIN 371

λ 0°



60°

6H



M ISO/DIN 13



N. PEZZI PIECES	M	CODE	€
6	3 - 4 - 5 - 6 8 - 10	551610000	136,80

N. PEZZI PIECES	M	CODE	€ QUARTZ
6	3 - 4 - 5 - 6 8 - 10	651610000	169,64

KIT M 517 INOX

DIN
371

λ
35°



λ
60°

6H



M
ISO/DIN
13



N. PEZZI PIECES	M	CODE	€
6	3 - 4 - 5 - 6 8 - 10	551710000	163,16

N. PEZZI PIECES	M	CODE	€ QUARTZ
6	3 - 4 - 5 - 6 8 - 10	651710000	198,44

KIT M 535

DIN
371

λ
0°



λ
60°

6H



M
ISO/DIN
13



N. PEZZI PIECES	M	CODE	€
6	3 - 4 - 5 - 6 8 - 10	553510000	100,70

N. PEZZI PIECES	M	CODE	€ QUARTZ
6	3 - 4 - 5 - 6 8 - 10	653510000	128,24

KIT M 536

DIN
371

λ
35°



λ
60°

6H



M
ISO/DIN
13



N. PEZZI PIECES	M	CODE	€
6	3 - 4 - 5 - 6 8 - 10	553610000	104,15

N. PEZZI PIECES	M	CODE	€ QUARTZ
6	3 - 4 - 5 - 6 8 - 10	653610000	133,50

KIT M 511



N. PEZZI PIECES	M	CODE	€	CODE	€ QUARTZ	CODE	€ TITANITE
6	3 - 4 - 5 - 6 8 - 10	551110000	116,53	651110000	148,62	751110000	161,80

KIT M 512



N. PEZZI PIECES	M	CODE	€	CODE	€ QUARTZ	CODE	€ TITANITE
6	3 - 4 - 5 - 6 8 - 10	551210000	119,13	651210000	151,49	751210000	164,66

KIT R 570



N. PEZZI PIECES	M	CODE	€
6	3 - 4 - 5 - 6 8 - 10	557010000	157,87

KIT R 571

DIN
371



6HX



M
ISO/DIN
13



N. PEZZI PIECES	M	CODE	€
6	3 - 4 - 5 - 6 8 - 10	557110000	157,87

KIT R 572

DIN
371



6HX



M
ISO/DIN
13



N. PEZZI PIECES	M	CODE	€
6	3 - 4 - 5 - 6 8 - 10	557210000	183,67

KIT M 524 GHISA

DIN
371



6H



M
ISO/DIN
13



N. PEZZI PIECES	M	CODE	OPAL €
6	3 - 4 - 5 - 6 8 - 10	552410000	167,46

CL 11



CL 21TF



CL11



CL21TF



N. PEZZI PIECES	Ø	CODE	RESISTOR 2119..... € SAPPHIRE MULTI
6	6 - 8 - 10 - 12 - 16 - 2070030	304,06

N. PEZZI PIECES	Ø	CODE	RESISTOR 2219..... € SAPPHIRE MULTI
6	6 - 8 - 10 - 12 - 16 - 2080030	331,04

CL 24TF



CL 24TFPF



CL24TF



CL24TFPF



N. PEZZI PIECES	Ø	CODE	RESISTOR 2249..... € SAPPHIRE MULTI
6	6 - 8 - 10 - 12 - 16 - 2090030	508,92

N. PEZZI PIECES	Ø	CODE	RESISTOR 2249..... € SAPPHIRE MULTI
6	6 - 8 - 10 - 12 - 16 - 2010030	598,76

CL 11HM



N. PEZZI PIECES	Ø	CODE	Micrograin Carbide Co10
			2119..... € SAPHIRE
5	6 - 8 - 10 12 - 1610008	403,96

CL 16HM



N. PEZZI PIECES	Ø	CODE	Micrograin Carbide Co10
			2169..... € SAPHIRE
5	6 - 8 - 10 12 - 1620008	403,96

CL 18HM



N. PEZZI PIECES	Ø	CODE	Micrograin Carbide Co10
			2189..... € SAPHIRE
5	6 - 8 - 10 12 - 1640008	464,48

CL 21TFHM



CL 21EDHM



CL21TFHM



CL21EDHM



N. PEZZI PIECES	Ø	CODE	Micrograin Carbide Co10
			2219..... € SAPPHIRE
5	6 - 8 - 10 12 - 1640008	407,21

N. PEZZI PIECES	Ø	CODE	2219..... € SAPPHIRE
		50008
5	6 - 8 - 10 12 - 1650008	398,84

CL 19HM



N. PEZZI PIECES	Ø	CODE	Micrograin Carbide Co12
			2199..... € SAPPHIRE
5	6 - 8 - 10 12 - 1650008	775,47

CL 26HM



N. PEZZI PIECES	Ø	CODE	Micrograin Carbide Co12
			2269..... € SAPPHIRE
5	6 - 8 - 10 12 - 1660008	542,29

set di lime rotative set of rotary burrs



F1225
F1020
D1210
D1009
C0616
C1020
B1020
B1225

Code USA	KIT €
40610000S	254,10
40110000S	330,33

set di lime rotative mm 3 codolo 3 set of rotary burrs mm 3 cod 3



formes
A
C
D
E
F
G
H
J
M
N

Code USA	KIT €
40620000S	94,46

HSS-HSSCo

L'acciaio rapido (HSS) è uno dei materiali più importanti nella produzione di utensili da taglio, poiché presenta buone caratteristiche di durezza, tenacità e resistenza all'usura, ed è quindi utilizzabile in una vasta gamma di applicazioni. Aggiungendo una % di cobalto nella sua composizione, si ha l'acciaio super-rapido (HSS-Co), che possiede una più elevata resistenza al calore senza peraltro compromettere la resistenza all'usura e la tenacità.

HSS steel is one of the most important materials used in the production of cutting tools because it offers good hardness features, high tensile strength and wear resistance and can be therefore used on a wide range of applications. By adding a Cobalt % in its composition you obtain High Speed Steel with higher heat resistance, thus not compromising wear resistance and tensile strength.

	UNI EN ISO 4957 (2002)	%						HRC
HSS	HS 6-5-2	C=0,90	Cr=4,20	Mo=5	W=6,50	Co=0	V=2	62-64
HSS+5%Co	HS 6-5-2-5	C=0,93	Cr=4,20	Mo=5	W=6,40	Co=4,8	V=1,80	60-66,5
HSS+8%Co	HS 2-9-1-8	C=1,08	Cr=3,90	Mo=9,4	W=1,40	Co=8	V=1,20	64,5-67,5

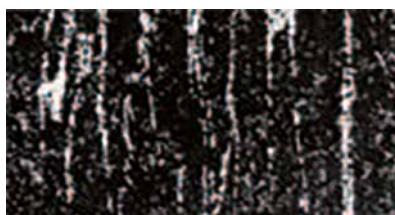

STRUTTURA HSS - STRUCTURAL HSS

RESISTOR (ASP)

La linea RESISTOR(ASP) della carmon è costruita con uno speciale acciaio ottenuto tramite un procedimento di metallurgia delle polveri il quale, rispetto alla metallurgia tradizionale, permette di ottenere una microstruttura più fine ed omogenea e quindi migliori proprietà meccaniche, in particolare elevata durezza e una migliore resistenza all'usura. Rispetto ad un acciaio rapido o super rapido, si aumentano i parametri di lavorazione, si ottiene una maggiore durata dell'utensile, e si possono lavorare acciai fino a 52 HRC.

Carmon line of products denominated RESISTOR is made out of a special powder metallurgically produced steel grade (ASP) which presents a finer and more homogeneous microstructure with better mechanical properties, particularly high hardness with better wear resistance. RESISTOR offers higher machining parameters and longer tool life over a conventional HSS or HSSCO, furthermore RESISTOR can machine materials up to 52 HRC.

	UNI EN ISO 4957 (2002)	%						HRC
HSS-E-PM RESISTOR	HS 10-2-5-8	C=1,60%	Cr=4,80%	Mo=2%	W=10,50%	Co=8%	V=5%	65,5-67

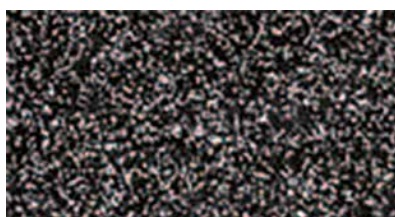

STRUTTURA ASP - STRUCTURAL ASP

METALLO DURO - HARD METAL

Il metallo duro è essenzialmente costituito da particelle di carburo di tungsteno unite a cobalto, e si ottiene dalla metallurgia delle polveri. La micrograna si riferisce alla dimensione delle particelle di carburo.

Carmon ha introdotto nella propria gamma di utensili due qualità di metallo duro, con caratteristiche chimiche, fisiche e meccaniche diverse in funzione della lavorazione che l'utensile deve svolgere.

MGCo10 "extrafine" ha un grado di micro-grana con elevata durezza e buona resistenza all'usura, tale da permettere l'utilizzo dell'utensile in una gamma più ampia di materiali.

MGCo12 "ultrafine" è caratterizzato da un'alta percentuale di carbonio e una grana ultrafine che permettono lavorazioni a velocità più elevate."

Hard Metal is composed by tungsten carbide particles with cobalt and is produced with a powder metallurgy process. Micro-grain refers to the size of carbide particles.

Carmon has introduced in its cutting tool range two grades of solid carbide with different chemical, physical and mechanical features in order to match the requirements of each application.

MGCo10 "extrafine" has a micro-grain size with high hardness and good wear resistance that allows machining of a wide range of materials.

MGCo12 "ultrafine" has a high carbide content and an ultrafine grain size and is specifically designed for high speed machining.

Tipo/Type	Grandezza/Size	WC	Co	Durezza Hardness HV30	Resistenza alla flessione Resistance to bending stress N/mm ²	Densità Density g/cm ³
MicrograinCo10	Extrafine 0,8 micron	89,70%	10%	1580	3800	14,49
MicrograinCo12	Ultrafine <0,8 micron	87,70%	12%	1700	>3800	14,11



MICROGRAIN Co10



MICROGRAIN Co12

RIVESTIMENTI A CATALOGO STANDARD - CARMON STANDARD COATINGS





Caratteristiche Tecniche Technical Features	Quartz	Pearl	Opal	Sapphire Multi	Sapphire	Titanite
Colore Colour						
Composizione di base Coating Material	TiN	TiCN/MoS2	TiCN	Multilayer TiAlN	AlTiN	AlTiN/C
Microdurezza (HV 0.05) Microhardness (HV 0.05)	2.300	3'500	3.500	3.500	3.700	3.700
Coefficiente d'attrito contro 100 Cr 6 Friction Coefficient against 100 Cr 6	0.6	0.5	0.5	0.4	0.5	0.1
Spessore (µm) Thickness (µm)	1 - 4	1 - 4	1 - 4	1 - 3	1 - 2	2 - 3
Temperatura di Deposizione (°C) Deposition Temperature (°C)	140 - 480	350-480	350 - 480	480	480	480
Resistenza all'Ossidazione (max. °C) Oxidation Resistance (max. °C)	600	400	400	700	800	800
Applicazioni Applications	Acciai da costruzione >800 N/mm, acciai inox Structural Steels >800 N/mm, Stainless Steels	Acciaio inossidabile Stainless Steel	Tutti gli acciai da costruzione, acciai da cementazione, acciai da bonifica <1200 N/mm, Alluminio e sue leghe, leghe di titanio, materie plastiche. Structural Steel, casehardening steel, Tempered Steel <1200 N/mm, Aluminium and its alloys, Plastics.	Per ogni tipo di materiale Any type of material	Per ogni tipo di materiale Any type of material	Per ogni tipo di materiale Any type of material

A RICHIESTA - CARMON COATINGS OFFERED ON REQUEST

Caratteristiche Tecniche Technical Features	Sapphire Multi sleek	Sapphire sleek	Diamond
Colore Colour			
Composizione di base Coating Material	Multilayer TiAlN	AlTiN	Carbonio
Microdurezza (HV 0.05) Microhardness (HV 0.05)	3'500	3'700	10'000
Coefficiente d'attrito contro 100 Cr 6 Friction Coefficient against 100 Cr 6	0.1	0.1	0.6
Spessore (µm) Thickness (µm)	1 - 3	1 - 2	4 - 10
Temperatura di Deposizione (°C) Deposition Temperature (°C)	480	480	
Resistenza all'Ossidazione Oxidation Resistance (°C)	700	800	1000
Applicazioni Applications	Per ogni tipo di materiale Any type of material	Per ogni tipo di materiale Any type of material	Grafite Graphite

Sleek è una nuova lavorazione che avviene nel post rivestimento e serve a ridurre il coefficiente d'attrito superficiale dell'utensile. Questo migliora notevolmente la lavorazione di materiali con scarsa evacuazione del truciolo (rame, ottone, bronzo, alluminio e sue leghe). Viene applicata principalmente ai nostri rivestimenti SAPPHIRE MULTI e SAPPHIRE.

"SLEEK" is a new surface treatment which is applied after coating in order to reduce friction coefficient on the cutting tool surface. This treatment improves machining process on those materials which present difficult chip flow (copper, brass, bronze, aluminum and its alloys). "Sleek" is applied mainly on the coatings "Sapphire Multi" and "Sapphire".

LAVORAZIONI APPLICATION					
Materiali da lavorare: Materials to be machined:	HSS-Co/RESISTOR	HM	HSS-Co	HM	HSS-Co/RESISTOR
Acciai non legati Unalloyed steels	Sapphire Multi	Sapphire	Quartz	Sapphire	Quartz
Acciai legati: Alloyed Steels:	Sapphire Multi	Sapphire	Quartz	Sapphire	Opal
Acciai < 50 HRC Steel < 50 HRC	Sapphire Multi	Sapphire	Titanite	Sapphire	Pearl
	Sapphire Multi sleek				
Acciai > 50 HRC Steel > 50 HRC	/	Sapphire	/	Sapphire	/
		Sapphire sleek			
Acciai Inossidabili Stainless Steel	Pearl	Sapphire	Titanite	Sapphire	Pearl
		Sapphire sleek			
Ghisa Cast Iron	Sapphire Multi	Sapphire	/	Sapphire sleek	Titanite
	Sapphire Multi sleek	Sapphire sleek			
Leghe di Titanio Titanium, alloyed	Sapphire Multi	Sapphire	Titanite	Sapphire sleek	Titanite
Rame Copper	Sapphire Multi sleek	Sapphire sleek	Titanite	Sapphire sleek	Pearl
Ottone / Bronzo / Alpacca Brass / Bronze / Nickel Silver	Sapphire Multi sleek	Sapphire sleek	Titanite	Sapphire sleek	Pearl
Plastiche Plastics	Sapphire Multi sleek	Sapphire sleek	Titanite	Sapphire sleek	Titanite
Alluminio con Si < 10% Aluminium with Si < 10%	Sapphire Multi sleek	Sapphire sleek	Titanite	Sapphire sleek	Titanite
Alluminio con Si > 10% Aluminium with Si > 10%	Sapphire Multi sleek	Sapphire	Titanite	Sapphire	Titanite
		Diamond		Diamond	
Alluminio e Magnesio Aluminium and Magnesium	Sapphire Multi sleek	Sapphire	Titanite	Sapphire sleek	Titanite
Grafite Graphite	/	Sapphire Multi	/	Sapphire	Titanite
		Diamond		Diamond	
Materiali Compositi Composites	/	Sapphire sleek	/	Sapphire	Titanite
		Diamond		Diamond	

CLASSIFICAZIONE DEI MATERIALI GROUPS OF MATERIALS

ESEMPI DI MATERIALI - MATERIAL EXAMPLE

		W. - Nr.	DIN	EN	B.S.	AISI/SAE	SS
- Acciai sino a 500 N/mm2	- Steels up to 500 N/mm2	1.0037	ST 37-2	EN 10025	FE 360 B	M 1010	1311
- Acciai da costruzione	- Construction steels	1.0044	ST 44-2	EN 10025	FE 430 B FN	M 1015	1412
- Acciai alta velocità	- Steels for automatic lathes	1.0711	9 S 20	1651	220 M 07		
		1.0715	9 SMn 28	1651	230 M 07	1213	1912
		1.0718	9 MnPb 28	1651		12 L 13	1914
1							
- Acciai sopra 500 - 800 N/mm2	- Steels more than 500 - 800 N/mm2	1.0060	St 60-2	EN 10025	4360-55E; 55C	A572 GR.65	1650
- Acciai da costruzione	- Construction steels	1.0503	C 45	EN 10083-2	080 M 46	1045	1672
- Acciai alta velocità	- Steels for automatic lathes	1.0570	St 52-3	EN 10025	4360-50 D		2134
- Acciai da cementazione	- Case hardening steels	1.0727	45 S 20	1651		1146	
- Acciai da bonifica	- Tempering steels	1.1141	Ck 15	1652T.3	080 M15	1015	1370
- Acciai da utensili nonlegati	- Non-alloyed tools steels	1.1191	Ck 45		080 M 46	1045	1672
- Titanio non legato	- Non-alloyed titanium						
- Ghisa grigia < 180 HB	- Cast iron < 180 HB						
2							
- Acciai sopra 800 - 1000 N/mm2	- Steels more than 800 - 1000 N/mm2	0.6020	GG 20		GRADE 220	A48-30B	0120-00
		0.7040	GGG 40		420/12	60-40-18	0717-02
- Acciai da cementazione	- Case hardening steels	0.8035	GTW-35				
- Acciai da bonifica	- Tempering steels	0.8135	GTS-35		B 340/12	32510	
- Acciai da nitrurazione	- Nitriding steels	1.1167	36 Mn 5	17204	150 M 36	1335	2120
- Acciai da costruzione resistenti al calore	- Heat resistant construction steels	1.1221	Ck 60	EN 10083-1	060 A 62	1060	1665
- Ghisa grigia > 180 HB	- Cast iron > 180 HB	1.2312	40 CrMnMoS 8 6	17350			
		1.5732	14 NiCr 10				3415
		1.5775	31 NiCr 14		653 M 31		
		1.7131	16 MnCr 5		572 M 17	5115	2173
		1.7225	42 CrMo 4	EN 10083-1	708 M 40	4140	2244
		1.8504	34 CrAl 6				
		1.8507	34 CrAlMo 5	17211		A355 Cl.D	
		1.8509	41 CrAlMo 7		905 M 39	A355 Cl.A	2940
		1.8515	31 CrMo 12	17211	722 M 24		2240
3							
- Acciai sopra 1000 - 1300 N/mm2	- Steels more than 1000 - 1300 N/mm2	0.6030	GG 30		GRADE 300	A48-45B	0130-00
		0.7050	GGG 50		500/7	65-45-12	0727-02
- Acciai da cementazione	- Case hardening steels	0.7060	GGG 60		600/3	80-55-06	0732-03
- Acciai da bonifica	- Tempering steels	0.8065	GTW-65				
- Acciai da nitrurazione	- Nitriding steels	0.8170	GTS-70		P 690		
- Acciai da utensili per lavorazioni a caldo	- Hot working steels	1.2067	102 Cr 6	17350	BL 3	L 3	
- Acciai inossidabili ferritici	- Ferritic Stainless steel	1.2311	40 CrMnMo 7				
- Acciai inossidabili ferritici	- Titanium alloys	1.2312	40 CrMnMoS 8 6	17350			
- Leghe di titanio		1.2343	X 38 CrMoV 5-1	17350	BH 11	H 11	
		1.2344	X40CrMoV 5-1	17350	BH13	H13	HARDOX600
		1.2510	100 MnCrW 4		BO 1	O 1	HARDOX400 500
		1.2710	45 NiCr 6				
		1.2711	54 NiCrMo V 6				
		1.2714	56 NiCrMoV 7	17350			
		1.2833	100 V 1		BW 2	W 210	
		1.2842	90 MnCrV 8	17350	BO 2	O 2	
		1.3565	48 CrMo 4	17230	817 M40		
		1.4002	X 6 CrAl 13	E EN 10088	405 S 17	405	2302
		1.4006	X 10 Cr 13	E EN 10088	410 S21	410	
		1.4028	X 30 Cr 13	E EN 10088	420 S 45	420F	2304
		1.6587	17 CrNiMo 6	1672 T.3	820 A 16		
		1.8519	31 CrMoV 9	17211			
		1.8550	34 CrAlNi 7	17211			
		1.8550	34 CrAlNi 7	172111.4301	X 5 CrNi 18 10	E EN 10088	304 S 15

CLASSIFICAZIONE DEI MATERIALI GROUPS OF MATERIALS

ESEMPI DI MATERIALI - MATERIAL EXAMPLE

		W. - Nr.	DIN	EN	B.S.	AISI/SAE	SS
- Acciai da utensili per lavorazioni a freddo 12% Cr	- Tool steels for cold machining 12% Cr	1.2080	X 210 Cr 12	17350	BD 3	D 3	
- Acciai resistenti al calore = 17% Ni e 17% Cr	- High temperature steels = 17% Ni and 17% Cr	1.2379	X 155 CrVMo 12-1	17350	BD 2	D 2	2310
- Acciai inossidabili austenitici	- Austenitic stainless steel	1.2436	X 210 CrW 12	17350			2312
- Leghe di titanio indurite	- Titanium alloys hardened	1.2601	X 165 CrMoV 12	17350			
- Leghe a base di nichel non indurenti	- Nickel-based alloys	1.4301	X 5 CrNi 18 10	E EN 10088	304 S 15	304	2332
		1.4305	X 12 CrNi S 18 9	E EN 10088	303 S 22	303	2346
		1.4571	X 6CrNiMoTi 17-12-2	E EN 10088	320 S 18	316 Ti	2350
		1.4876	Incoloy 800	SEW 470	NA 15	B 163	
		1.4923	X 22 CrMoV 12-1	17240			
		1.4945	X 6 CrNiWNb 16 16				
		1.4962	X 12 CrNiWTi 16-13				
		1.5920	18 CrNi 8				
		1.6582	34 CrNiMo 6	EN 10083-1			
		2.4632	Nimonic 90	LW			
		2.4654	Waspalloy	LW			
		2.4665	Hastelloy X	LW			
		2.4670	Inconel 713	LW			
		2.4816	Inconel 600	17742			
		2.4856	Inconel 625	17744			
5							
- Leghe resistenti al calore	- Higt temperature alloys	2.4636	Udimet 700				
- Leghe a base di nichel indurenti	- Nickel-based alloys	2.4668	Inconel 718				
		2.4973	René 41				
			Astroloy				
			René 95				
			Stellite 6				
6							
- Alluminio puro	- Pure aluminium	3.0255	Al 99,5				
- Leghe d'alluminio non bonificato	- Non-hardened aluminium	3.2315	AlMgSi 1				
- Materiali malleabili	- Forging materials	3.3211	AlMg 1 SiCu				
		3.3535	AlMg 3				
		3.4365	AlZnMgCu 1,5				
7							
- Leghe d'alluminio bonificato	- Hardened aluminium	3.2151	G-Al Si6 Cu 4				
- Materiali malleabili	- Forging materials	3.2341	G-ALSi 5 Mg				
- Getti in lega leggera Si ≤ 10%	- Aluminium cast material Si ≤ 10%	3.2373	G-ALSi 9 Mg				
8							
- Getti in lega leggera Si > 10%	- Aluminium cast material Si > 10%	3.2381	G-ALSi 10 Mg				
- Leghe rame - zinco (ottone)	- Copper - zinc alloys (brass)	3.2581	G-ALSi 12				
- Leghe rame - stagno (bronzo)	- Copper - zinc alloys (bronze)		ALSi 17 Cu 4				
- Duroplastica laminata	- Duroplast laminated		Al Si 21 CuNiMg				
			ALSi 25 CuNiMg				
9							

TIPO DI ESECUZIONE DELLE PUNTE ELICOIDALI TWIST DRILLS EXECUTIONS

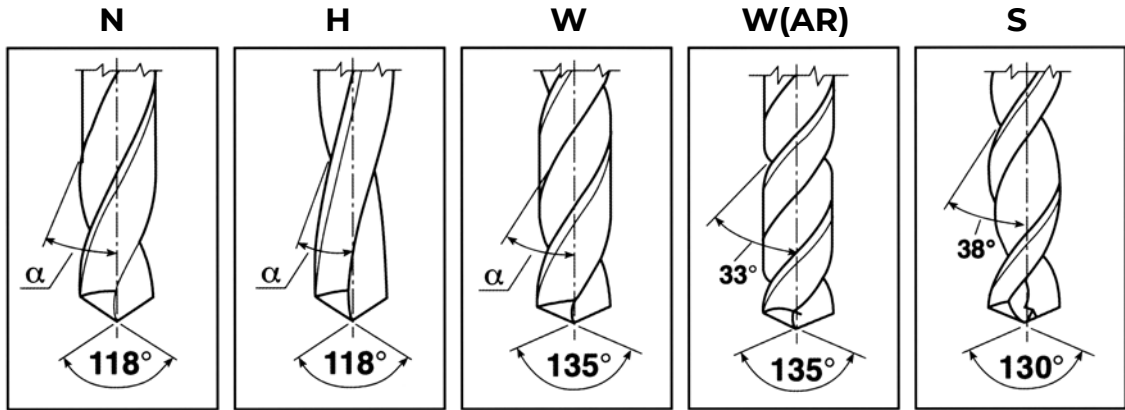

α = Inclinazione dell'elica / Helix angle

Gruppi di diametri - Diameter groups	Esecuzione - Execution		
	α		
mm	N	H	W
0 ÷ 0,6	$18^\circ \pm 20^\circ$	-	-
0,6 ÷ 1	$20^\circ \pm 26^\circ$	-	-
1 ÷ 3,2	$22^\circ \pm 28^\circ$	$12^\circ \pm 15^\circ$	$30^\circ \pm 38^\circ$
3,2 ÷ 5	$24^\circ \pm 30^\circ$	$14^\circ \pm 15^\circ$	$30^\circ \pm 40^\circ$
5 ÷ 10	$25^\circ \pm 32^\circ$	$16^\circ \pm 18^\circ$	$35^\circ \pm 42^\circ$
10 ÷ >	$26^\circ \pm 34^\circ$	$18^\circ \pm 20^\circ$	$35^\circ \pm 42^\circ$

AFFILATURE SPECIALI - SPECIAL SHARPENING

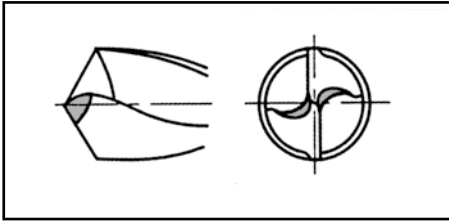

DIN 1412 forma A
Assottigliamento del nucleo;
riduce lo spessore del nucleo e
quindi la pressione di
penetrazione, migliorando le
condizioni di taglio. Viene
utilizzata per punte riaffilate e per
punte lunghe.

DIN 1412 shape A
Web thinning; reduces web
thickness and therefore feed
pressure thereby improving
cutting conditions.
Used for re-sharpened and long
bits.

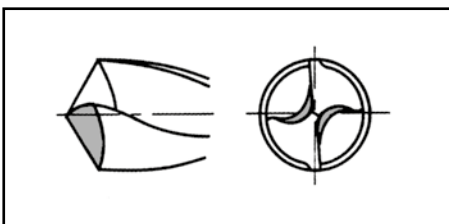

DIN 1412 forme B
Assottigliamento del nucleo con
correzione del tagliente; riduce lo
spessore del nucleo permettendo
la correzione del tagliente.

DIN1412 forma B
Web thinning with cutting edge
correction; reduces web thickness
to enable cutting edge correction.

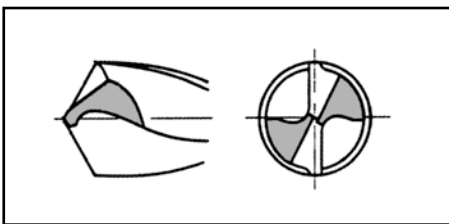

DIN1412 forma C
Affilatura a croce o affilatura a
diamante; utilizzata su punte per
fori profondi. La forma
dell'angolo in punta favorisce
l'asportazione
del truciolo e riduce la pressione
di penetrazione.

DIN1412 shape C
Split point or diamond type
sharpening; used on bits for deep
drilling. The point angle geometry
facilitates chip removal and feed
pressure.

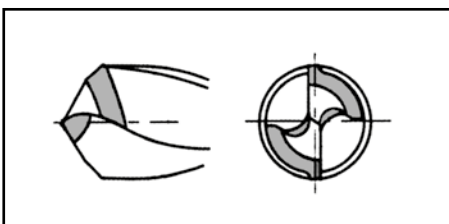

DIN1412 forma D
Affilatura per ghisa grigia; la
smussatura degli spigoli esterni
consente di irrobustire il
tagliente. Viene usata per ghisa di
durezza media o elevata e per
materiali abrasivi.

DIN1412 shape D
Gray cast iron sharpening;
beveling of external edges
strengthens the cutting edge.
Used for medium to high gray
cast iron hardness and for
abrasives

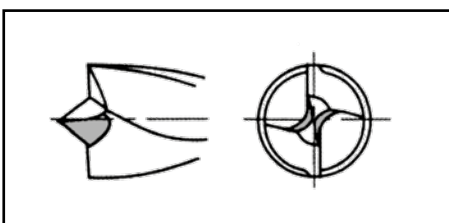

DIN1412 forma E
Affilatura per punta a centrare;
consente una buona centratura,
non lascia bava nei fori passanti.
Poiché la punta e i lati taglienti
sono delicati, conviene utilizzarla
per forature di lamiera sottili.

DIN1412 shape E
Centre drill bit sharpening; ensures
optimal centre drilling and does
not leave burrs in through-holes.
As the bit and cutting edges are
delicate, this bit should be used
for drilling thin sheet metal.

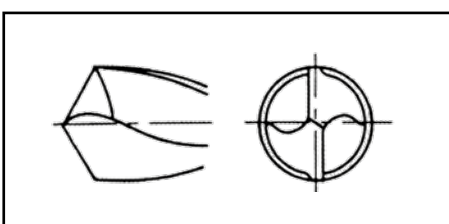

AFFILATURA STANDARD

STANDARD SHARPENING

ANELLI COLORATI PER MASCHI A MACCHINA COLOURED RINGS FOR MACHINE TAPS



I maschi con anello rosso sono costruiti per la maschiatura di acciai tenaci, leghe di Titanio, Nichel. Si consiglia l'utilizzo di refrigerante; olio da taglio integrale o emulsione al 4% - 5%

Main Application: Tough Steels (1200-1400 N/mm²), Titanium and Nickel Alloys.
Coolant: full cutting oil or emulsion at 4 - 5%



I maschi con anello blu, sono costruiti per la maschiatura di acciai inox, acciai pastosi (teneri) fino a 750 N/mm². Come refrigerante si consiglia l'uso di olio da taglio integrale.

Main Application: Stainless steels and soft steels up to 750 N/mm².
Coolant: full cutting oil.



I maschi con anello verde sono costruiti per la maschiatura di leghe e derivati alluminio, rame, ottone, bronzo. Refrigerante olio da taglio integrale, emulsione al 6% - 8%

Main application: Aluminium and its alloys, copper, brass, bronze.
Coolant: full cutting oil or emulsion at 6 - 8%



I maschi con anello bianco sono costruiti per la maschiatura di ghisa grigia, sferoidale (GG-GGG), materiali abrasivi a truciolo corto.

Main application: Cast Iron, Spheroidal Cast Iron (GG-GGG), abrasives materials with short chips.



I maschi con anello giallo sono costruiti per la maschiatura di acciai con resistenza medio/bassa. Possono essere impiegati per acciai da costruzione, acciai legati-bonificati, rame, leghe di rame e ottone. Si consiglia l'utilizzo di refrigerante; olio da taglio integrale o emulsione al 4% - 5%.

Main application: low resistance steel. These taps can be used on construction steel, tempered and alloyed steel, copper, copper alloys and brass.
Coolant: we suggest the use of full oil or 4%-5% emulsion.



I maschi con anello arancione di nuova produzione, sono costruiti per la maschiatura di acciai tenaci si consiglia l'utilizzo in maschiatura rigida con refrigerante olio da taglio integrale o emulsione allo 4% - 5%

Taps with orange ring of new production, they are built for tapping tough steels and we recommend using rigid tapping with coolant full cutting oil or emulsion at 4% - 5%.

IMBOCCO - CHAMFER

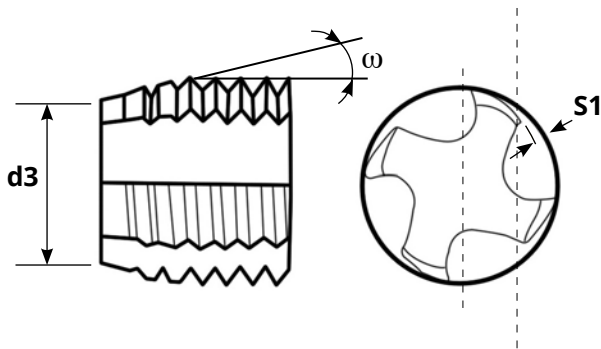

d3) diametro imbocco
chamfer diameter

ω Angolo d'imbocco
Chamfer angle

S1) Spoglia radiale sull'imbocco
Chamfer radial relief

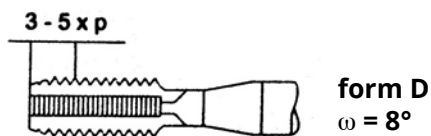
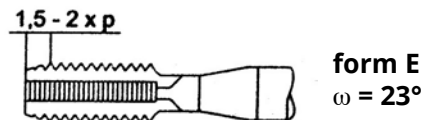
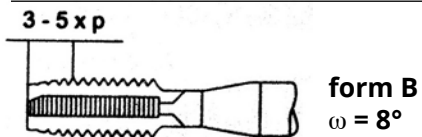
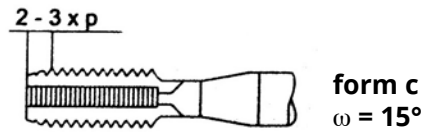
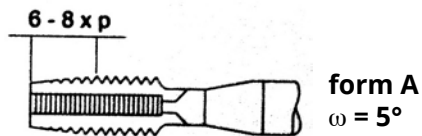

TOLLERANZE - TOLERANCES ($\mu\text{m} = 0,001 \text{ mm}$)

D	H7	H8	H11	d9	d11	e8	f8	h6	h8	h10	h11	h12	js14	js16	k11	k16	m7
1÷3	0	0	0	-20	-20	-14	-7	0	0	0	0	0	+125	+300	+60	+600	+12
	+9	+14	+60	-45	-80	-28	-21	-7	-14	-40	-60	-100	-125	-300	0	0	+1
3÷6	0	0	0	-30	-30	-20	-10	0	0	0	0	0	+150	+375	+75	+750	+16
	+12	+18	+75	-60	-105	-38	-28	-8	-18	-48	-75	-120	-150	-375	0	0	+4
6÷10	0	0	0	-40	-40	-25	-13	0	0	0	0	0	+180	+450	+90	+900	+21
	+15	+22	+90	-76	-130	-47	-35	-9	-22	-58	-90	-150	-180	-450	0	0	+6
10÷18	0	0	0	-50	-50	-32	-16	0	0	0	0	0	+215	+550	+110	+1100	+25
	+18	+27	+110	-93	-160	-59	-43	-11	-27	-70	-110	-180	-215	-550	0	0	+7
18÷30	0	0	0	-65	-65	-40	-20	0	0	0	0	0	+260	+650	+130	+1300	+29
	+21	+33	+130	-117	-195	-73	-53	-13	-33	-84	-130	-210	-260	-650	0	0	+8
30÷50	0	0	0	-80	-80	-50	-25	0	0	0	0	0	+310	+800	+160	+1600	+34
	+25	+39	+160	-142	-240	-89	-64	-16	-39	-100	-160	-250	-310	-800	0	0	+9
50÷65	0	0	0	-100	-100	-60	-30	0	0	0	0	0	+370	+950	+190	+1900	+41
	+30	+46	+190	-174	-290	-106	-76	-19	-46	-120	-190	-300	-370	-950	0	0	+11
65÷80	0	0	0	-100	-100	-60	-30	0	0	0	0		+370	+950	+190	+1900	+41
	+30	+46	+190	-174	-290	-106	-76	-19	-46	-120	-190		-370	-950	0	0	+11
80÷100	0	0	0	-120	-120	-72	-36	0	0	0	0		+435	+1100	+220	+2200	+48
	+35	+54	+220	-207	-340	-126	-90	-22	-54	-140	-220		-435	-1100	0	0	+13
100÷120	0	0	0	-120	-120	-72	-36	0	0	0	0		+435	+1100	+220	+2200	+48
	+35	+54	+220	-207	-340	-126	-90	-22	-54	-140	-220		-435	-1100	0	0	+13
120÷140	0	0	0	-145	-145	-85	-43	0	0	0	0		+500	+1250	+250	+2500	+55
	+40	+63	+250	-245	-395	-148	-106	-25	-63	-160	-250		-500	-1250	0	0	+15
140÷160	0	0	0	-145	-145	-85	-43	0	0	0	0		+500	+1250	+250	+2500	+55
	+40	+63	+250	-245	-395	-148	-106	-25	-63	-160	-250		-500	-1250	0	0	+15
160÷180	0	0	0	-145	-145	-85	-43	0	0	0	0		+500	+1250	+250	+2500	+55
	+40	+63	+250	-245	-395	-148	-106	-25	-63	-160	-250		-500	-1250	0	0	+15
180÷200	0	0	0	-170	-170	-100	-52	0	0	0	0		+575	+1450	+290	+2900	+63
	+46	+72	+290	-285	-460	-172	-122	-29	-72	-185	-290		-575	-1450	0	0	+17

Carmon
High Precision Tooling

LEGENDA LEGEND

CONDIZIONI GENERALI DI VENDITA

I prezzi del presente listino si intendono alle condizioni di sconto vigenti al momento della spedizione. Eventuali variazioni di sconto saranno comunicate preventivamente.

La spedizione della merce si intende, salvo condizioni precedentemente pattuite, franco ns. stabilimento o deposito. La merce viaggia sempre, in ogni caso, ad esclusivo rischio del committente. Non si accettano reclami se non pervenuti entro sette giorni dal ricevimento della merce.

La consegna del materiale è generalmente pronta a magazzino, salvo casi particolari.

In questi casi i tempi di consegna sono indicativi e comunque non impegnativi.

Tutte le ordinazioni, anche se verbali, si intendono sempre date ed eseguite alle condizioni sopra esposte.

Ogni eventuale clausola contenuta nel Vs. ordine, in contrario con quanto sopra, si intende priva di valore.

A richiesta si producono utensili con forme e dimensioni speciali; in questo caso sarà ns. cura comunicarVi i prezzi unitamente ai quantitativi minimi e ai tempi di consegna.

Nessun ritardo può costituire causa di annullamento dell'ordine o di rivalsa qualsiasi.

Non rispondiamo perciò di nessun danno dipendente da un ns. ritardo e la merce non può essere rifiutata per nessun motivo.

Il compratore è tenuto al pagamento integrale anche in casi di contestazione o controversia.

I pagamenti dovranno avvenire nei termini e negli accordi previsti; in caso di ritardato pagamento ci riserviamo di addebitarVi una penale pari al tasso bancario vigente in quel momento .

Gli utensili potranno essere sostituiti, previa autorizzazione della Direzione Commerciale.

La garanzia decade nel momento in cui gli utensili presentino una normale usura, un errato impiego oppure segni di manomissione.

Risponderemo comunque solamente della qualità e della tolleranza dei pezzi da noi prodotti e non del lavoro che da essi verrà eseguito.

Si esclude quindi ogni indennizzo a ns. carico all'infuori della sostituzione degli utensili riconosciuti difettosi.

Per ogni controversia che dovesse sorgere sarà competente il Foro di Brescia.

Tutti i dati sono stati redatti e controllati con la massima cura.

Non ci assumiamo comunque nessuna responsabilità per eventuali errori od omissioni.

La CARMON può a suo insindacabile giudizio cambiare in qualsiasi momento le caratteristiche ed i prezzi dei prodotti venduti.

GENERAL SALES CONDITIONS

The prices in the present list are applicable with discount conditions valid at the time of delivery.

Customers will be notified of any price variations in advance.

Goods delivery is ex our works/warehouse unless otherwise agreed. In any event goods transport remains the completely responsibility of the purchaser.

Claims will only be accepted if delivered within seven days of receipt of the said goods. Goods are generally ready for delivery from the warehouse, with the exception of special cases. In special cases delivery times are to be considered guideline only and not binding.

All orders, even if verbal, are considered issued and processed on the conditions specified above. Clauses in the customer's order that contradict the above, will be considered null and void.

Special tools with specific shapes and dimensions can be manufactured on request; in this case we will notify the customer of prices, minimum order quantities, and delivery times.

No delay constitutes cause for cancellation of the order or other recourse.

Therefore we shall not be held liable for damage caused by any delays and goods may not be refused under any circumstances.

The purchaser is obliged to fulfil total payment, also in the event of dispute or controversy.

Payments must be made within the agreed terms and methods; in the event of delayed payment, we reserve the right to make an extra charge equal to the current applicable bank rate.

Tools may be replaced with prior authorisation from the Sales Management.

The guarantee does not apply in the event of normal tool wear, incorrect use or evidence of tampering.

We shall be responsible exclusively for quality and tolerance of the tools we produce and not for the relative application.

Therefore all damages are excluded with the exception of piece replacement when acknowledged as defective.

The present conditions are subject to the exclusive jurisdiction of the Court of Brescia.

All the present information has been drawn up and checked thoroughly.

However we shall not be held liable for any errors or omissions.

CARMON reserves the right to modify prices and products at any time without notice.

GEOMETRIA DELLA GOLA
FLUTE GEOMETRY (pag 384)



INCLINAZIONE ELICA
HELIX ANGLE



ANGOLO AL VERTICE
POINT ANGLE



AFFILATURA
POINT GRINDING (pag 385)



LUNGHEZZA
LENGTH



INCLINAZIONE ELICA
HELIX ANGLE



VISTA FRONTALE
FRONT VIEW



TOLLERANZA
TOLLERANCE (ISODIN13)

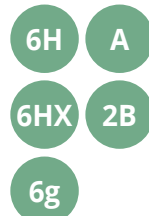

LUNGHEZZA
LENGTH



INCLINAZIONE ELICA
HELIX ANGLE



ANGOLO DEL DENTE
TOOTH ANGLE



ANGOLO DEL DENTE
TOOTH ANGLE



TOLLERANZA
TOLLERANCE



GEOMETRIA DELLA GOLA
FLUTE GEOMETRY (pag 342)



INCLINAZIONE ELICA
HELIX ANGLE



VISTA FRONTALE
FRONT VIEW



LUNGHEZZA
LENGTH

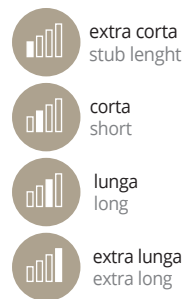

TAGLIENTI A SGROSSARE E SEMIFINIRE
ROUGHING AND SEMI-FINISHING CUTTING EDGE PROFILE

Ø	NR	HR	WR	NF
Ø 6 - Ø19	P.2			P.1,25
Ø20 - Ø30	P.3			
Ø32 - Ø75	P.4			



pag 337



GEOMETRIA DELLA GOLA
FLUTE GEOMETRY (pag 384)



LAVORAZIONI AD ALTA VELOCITÀ
HIGH SPEED CUTTING



VISTA FRONTALE
FRONT VIEW

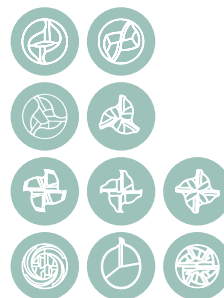

LUNGHEZZA
LENGTH

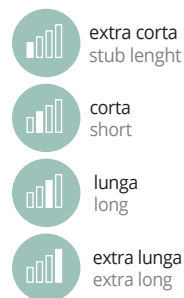

TAGLIENTI A SGROSSARE E SEMIFINIRE
ROUGHING AND SEMI-FINISHING CUTTING EDGE PROFILE



INCLINAZIONE ELICA
HELIX ANGLE



ANGOLO AL VERTICE
POINT ANGLE



AFFILATURA
POINT GRINDING (pag 385)



Taglio Alluminio
Aluminium Cut

Taglio singolo
Single Cut

Taglio rompitruciolo
Chip Breaker

Diamante
Diamant Cut

Taglio doppio
Double Cut

HSS

HSS+5%Co

HSS+8%Co

RESISTOR

HM

pag 378 - 379

QUARTZ

PEARL

OPAL

SAPPHIRE
MULTI

SAPPHIRE

TITANITE

pag 380 - 381

PUNTE HSS
HSS DRILLS

ALESATORI
REAMERS

MASCHI - FILIERE
TAPS - DIERS

TAMPONI-ANELLI
GAUGES- RINGS

FRESE HSS
HSS MILLING CUTTERS

FRESE E PUNTE HM
HM MILLING CUTTERS & DRILLS

LIME ROTATIVE HM
HM ROTARY BURRS

TECH INFO



Carmon

High Precision Tooling

UTENSILERIA CARMON s.r.l.
Via Matteotti, 162 - 25014
Castenedolo (Bs) ITALY
Tel. +39 030 2130555 - Fax +39 030 2731634
www.carmon.it - info@carmon.it



↓ catalog